

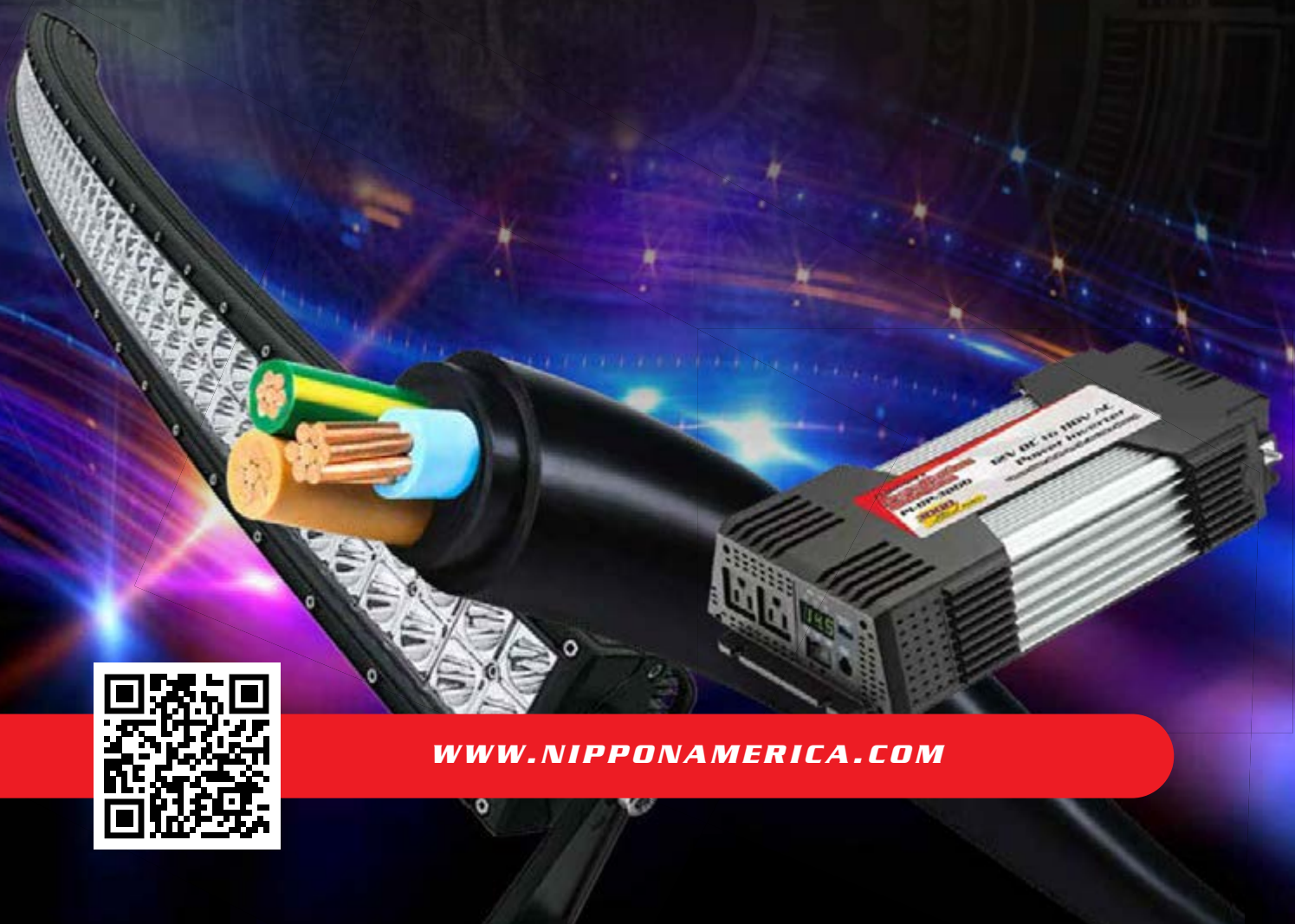

# 2022 CATALOG



[WWW.NIPPONAMERICA.COM](http://WWW.NIPPONAMERICA.COM)



For over 35 years, Okura USA has been connecting the world with electronic equipment that amplifies your lifestyle. Okura USA is a global manufacturer and distributor of 12-volt electronics, pro-audio equipment, marine audio equipment, and electronic audio/video accessories.

Okura USA is defined by loyalty, quality, and commitment – it is what sets us apart from the competition. Headquartered in Miami, FL, we serve our customers in nearly 40 countries around the world.

Whether at home, on the go, or playing a show, Okura USA delivers the electronic equipment you need.

We are very proud to offer the following brands within our portfolio:

- Nippon America (N.A.)
- Audiopipe Car Audio
- Audiopipe Marine
- Pipeman's Installation Solutions
- Zebra
- Studio Z
- iStuff

We guarantee the brands we represent.

# **TABLE OF CONTENTS**

<b>01</b>	Blister	<b>004</b>
<b>02</b>	HDMI	<b>020</b>
<b>03</b>	Video & Audio	<b>036</b>
<b>04</b>	Telephone Accessories	<b>080</b>
<b>05</b>	Gold Serie	<b>084</b>
<b>06</b>	Istuff	<b>092</b>
<b>07</b>	Computer Accessories	<b>102</b>
<b>08</b>	XXX	<b>116</b>
<b>09</b>	AudioDrift	<b>126</b>
<b>10</b>	PipeDream	<b>136</b>
<b>11</b>	Installation	<b>156</b>
<b>12</b>	Audio	<b>298</b>
<b>13</b>	AudioPipe Pro DJ	<b>358</b>
<b>14</b>	Pro Audio Cables	<b>394</b>
<b>15</b>	Zebra	<b>408</b>
<b>16</b>	Studio Z	<b>412</b>
<b>17</b>	Musical Equipment	<b>438</b>
<b>18</b>	Microphones	<b>468</b>
<b>19</b>	Disco Light	<b>478</b>
<b>20</b>	Power Products	<b>492</b>
<b>21</b>	Home Security	<b>542</b>



# 2022 CATALOG

**TIG**  
HIGH SPEED

180° Swivel type, 1080p  
Cable A male to A female

Cable HDMI Tipo Giratorio  
-180° A Macho a A Macho

**6'**

**Features:**

- 1.4 version (High Speed with Ethernet)
- Gold plated
- 1.4 HDMI CABLE

It can work for all previous HDMI 1.3 devices, 2011

- HDMI Ethernet Channel
- Audio Return Channel
- 3D, 4K, Content Type, Deep Color and CEC

**TIG**

HDMI Cable  
1080p 33M

**24'**

**TIG**

6'

VGA Female to  
VGA Male Cable

**TIG**

USB-KT

## BL-N-1000G

### 2 WAY CATV SPLITTER

- Connects to TVs and/or VCR from One Antenna
- 5-1,000MHz 75 Ohms CATV Signal "F" Splitter
- 75OHm Input, 75 Ohms UHF-VHF Output
- Gold



## BL-N-1003G

### 3 WAY CATV SPLITTER

- Connects to TVs and/or VCR from One Antenna
- 5-1,000MHz 75 Ohms CATV Signal "F" Splitter
- 75OHm Input, 75 Ohms UHF-VHF Output
- Gold



## BL-N-1005G

### 4 WAY CATV SPLITTER

- Connects to TVs and/or VCR from One Antenna
- 5-1,000MHz 75 Ohms CATV Signal "F" Splitter
- 75OHm Input, 75 Ohms UHF-VHF Output
- Gold



## BL-KL-412

### 2 WAY SPLITTER

- 5-1,000MHz
- Silver
- with Screws



## BL-KL-413

### 3 WAY SPLITTER

- 5-1,000MHz
- Silver
- with Screws





# SPLITTERS

## BL-KL-812A

### 2 WAY SPLITTER

- 5-2,400MHz
- Power Pass to all Ports
- Silver
- with Screws



## BL-KL-813A

### 3 WAY SPLITTER

- 5-2,400MHz
- Power Pass to all Ports
- Silver
- with Screws



## BL-KL-814A

### 2 WAY SPLITTER

- 5-2,400MHz
- Power Pass to all Ports
- Silver
- with Screws



## BL-KL-832A

### 2 WAY SPLITTER

- 5-2,400MHz
- Power Pass to all Ports
- Silver
- with Screws



## BL-KL-833A

### 3 WAY SPLITTER

- 5-2,400MHz
- Power Pass to all Ports
- Silver
- with Screws



## BL-KL-834A

### 4 WAY SPLITTER

- 5-2,400MHz
- Power Pass to all Ports
- Silver
- with Screws



## BL-KL-836A

### 6 WAY SPLITTER

- 5-2,400MHz
- Power Pass to all Ports
- Silver
- with Screws



## BL-KL-838A

### 8 WAY SPLITTER

- 5-2,400MHz
- Power Pass to all Ports



## BL-KL-920

### SATELLITE DIPLEXER

- Allows Off-Air Signals and Satellite Signals to be Fed on a Single Cable
- Can be used for Separating Signals as a Splitter or Combining Signals as a Combiner
- DC Power Pass is Provided from the Satellite Port to the Input in Order to Pass Satellite Receiver LNB Voltage



## BL-AC-006

### POWER CORD

- Frequency Response: 20 - 20kHz
- Impedance: 32 Ohms
- Sensitivity: 105dB
- 6'



## BL-V-175G

### RCA STEREO AUDIO/VIDEO CABLE

- Oxygen-Free
- Fully Molded
- Shielded Color Coded Wires
- Gold-Plated RCA Connectors
- 6'
- Heavy Duty



## BL-V-275G

### RCA STEREO AUDIO/VIDEO CABLE

- Oxygen-Free
- Fully Molded
- Shielded Color Coded Wires
- Gold-Plated RCA Connectors
- Heavy-Duty
- 6'



## BL-N-203-6G

### STEREO AUDIO CABLE

- 2 RCA to 2 RCA
- Gold-Plated Connectors
- Shielded Color Coded Wires
- 6'



## BL-N-211P-6G

### STEREO AUDIO CABLE

- 3.5mm to 2 RCA
- Gold-Plated Connectors
- Shielded Color Coded Wires
- 6"



## BL-N-3535-6GB

### 3.5MM STEREO AUDIO CABLE

- 6'
- Black
- Gold Connectors



## BL-N-3535-6GW

### 3.5MM STEREO AUDIO CABLE

- 6'
- White
- Gold Connectors





## CABLES

### BL-IP-35-USB6

3.5MM STEREO PLUG TO USB CABLE

- 6'
- White
- Gold Connector



### BL-IP-35-USB6FM

3.5 MM STEREO PLUG TO USB FEMALE

- 6'
- White Connects to Stereo/USB Equipment such as Car Radios to Stereo Receivers, Cassette Decks, CD Players, Etc.



USB

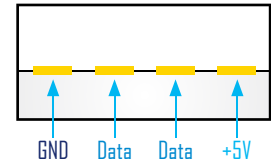

### BL-USB-30B30A

USB 3.0 AM TO MICRO BM CABLE

- Super Speed USB (USB 3.0) has a 5 Gbps Signalling Rate Offering 10x Performance Increase Over Hi-Speed USB
- Super Speed USB (USB 3.0) is a Sync-N-Go Technology that Minimizes User Wait-Time
- Super Speed USB (USB 3.0) will Provide Optimized Power Efficiency. No Device Polling and Lower Activate and Idle Power Requirements
- Super Speed USB (USB 3.0) is Backwards Compatible with USB 2.0 Devices Interoperate with USB 2.0 Platforms



### BL-USB-MICROU-3

USB AM (MALE) TO MICRO-USB (MALE) CABLE

- PVC Cable Jacket Material
- OD: Ø3.8mm
- Available in 3', 6'



Connect a Portable Device such as Cell Phone, PDA or Digital Camera with a USB Micro B Connection to your Computer or other USB Device.

### BL-USB-8MUSB-6

USB 2.0 A MALE TO MINI USB 8-PIN MALE CABLE

- Nickel-Plated Connectors
- Connectors: USB Type A Male to Type B Mini 8-Pin Male
- Make Plug and Play Connections with Cellular Phones, MP3 Players, Digital Cameras and PDAs
- Transfer Rates up to 480Mbps Depending on USB Version
- Foil and Braid Shielding Reduces EMI / RFI Interference thus Ensuring High-Speed, Error-Free Data Transmission



### BL-USBF-MIDTG

OTG CABLE (USB 2.0 FEMALE TO MICRO USB 5 PIN MALE CABLE

- Length: 11cm
- High Quality OTG Cable Adapter
- Suitable for Table PCs and Mobile Phones with Micro USB Port
- Easy to Use, Plug and Play
- Ability to Connect USB Mouse or Keyboard with your Table PC or Mobile Phone for Easy Operation
- Allows your Device to Connect with U-disk and Card Reader for Data Transmission





## BL-NF-56G

### F CONNECTOR FOR COAXIAL CABLE

- For Coaxial Cable with 6.5mm



## BL-F-81G

### FEMALE SPLICE CONNECTOR W/NUT

- For Coaxial Cable
- Gold



## BL-NF-1G

### F QUICK MALE TO F FEMALE CONNECTOR

- For Coaxial Cable
- Gold



## BL-F-29AG

### INDOOR TV ANTENNA

- Panasonic® Type Dual Antenna
- 5 Section Row with Gold Push on F Connector
- Built-In 3' Coaxial Cable



## BL-F-33AG

### INDOOR TV ANTENNA

- 31" Extended, Dual Chrome 4 Section Rod Antenna
- "F" Type Connector
- Chromed Double Loop Rings for Better Reception
- UHF/VHF Antenna with Coaxial Cable and Gold "F" Type Quick Connect Plug



## BL-N-38D

### "F" TYPE CONNECTOR

- 300  $\Omega$  to 75  $\Omega$  Balun Transformer



## BL-N-919G

### MATCHING TRANSFORMER

- Weather Resistant, Rubber Boot & Spade Terminal Included
- VHF/UHF Outdoor
- Gold Tips





## ACCESSORIES

### BL-IBM-205-6

USB CABLE AM (MALE)  
TO USB CABLE AF (FEMALE)

- 6'
- White
- Gold Connector



### BL-IBM-205-12

USB CABLE AM (MALE)  
TO USB CABLE AF (FEMALE)

- Interfaces High-Speed USB 2.0 Compliant Devices
- 12'



### BL-IBM-425-3

PATCH CORD

- Booted
- Stranded
- UL
- 50u Gold
- RJ45 Plugs
- 3'



### BL-IBM-425-6

PATCH CORD

- Booted
- Stranded
- UL
- 50u Gold
- RJ45 Rings
- 6'



### BL-IBM-A-B-6

USB CABLE AM (MALE) TO BM (MALE)

- PVC Cable Jacket Material
- OD: Ø4.5mm
- 6'



### BL-IBM-ABMIN-10

USB CABLE AM (MALE)  
TO BM MINI 5 PIN (MALE)

- Interfaces High-Speed USB 2.0 Compliant Devices
- Making Easy Plug & Play Connections
- 10'





# IBM ACCESSORIES

## BL-IBM-MOS300

### OPTICAL WHEEL MOUSE

- Windows and Mac
- Ergonomic Design
- Operating Distance: 15 Meters



## BL-IBM-WLRMOUSE

### 2.4G OPTICAL WIRELESS MOUSE

- Windows and Mac
- Ergonomic Design
- Operating Distance: 10 Meters



## BL-IBM-AFAF200

### A TYPE FEMALE COUPLER

- Platinum-Plated Connectors



## BL-IBM-ID4USB

### USB 4-PORT HUB

- Includes Hub and USB Cable
- Suitable for Notebooks



## BL-IBM-USB35-HM

### INTEGRATED 2CH USB AUDIO CONTROLLER

- Supports 3D Sounds (AC-3) and Virtual 5.1 Surround Sound Track
- The Best Entertainment for Listening to DVD, CD's and General Online Content
- Plug and Play, No Software Required
- Eliminate the Need for a Traditional Sound Card with this USB to Audio Adapter. Real USB Plug & Play Upgrade any On-Board Sound Card to 5.1 Digital
- Surround Sound without any Hardware Installation
- Connect a Speaker or Headphone Directly



## BL-IBM-KB370

### SLIM DESIGN USB KEYBOARD

- Comfortable to Use
- High-Quality Membrane Key Switch
- Key Stroke Life Time: 10,000,000 Cycles
- USB Interface
- Compatible with Windows Vista 7 and Windows 8
- Slim Design



## KEYBOARD SLIM



## IBM ACCESSORIES

### BL-IBM-KM700

#### WIRELESS KEYBOARD + MOUSE COMBO

##### MOUSE FEATURES:

- High Precision Optical Sensor (200PI)
- Precision Scroll Wheel
- Nano Receiver Receptacle
- Auto Standby Mode
- On/Off Switch
- Requires (2) AAA Batteries, Not Included

##### KEYBOARD FEATURES:

- Unique Slim Design, Stylish Configuration, Comfortable Feeling
- Compatible with all Operating Systems
- Requires (1) AA Battery, Not Included

##### ADVANCED WIRELESS:

- Advanced 2.4 GHz RF Wireless Technology, Provides up to a 10 Meter Multi-Directional Range and Practicality Interface Free Use

## Wireless KEYBOARD and Mouse



**12M, 360°  
Transmission**

### BL-IBM-WKB-400

#### WIRED WASHABLE KEYBOARD

- Key: 103K, Port: USB
- Conductive Silver Paste
- Laser Etching Font
- Switch Life More than 5,000,000 Times
- Can be Washed Easily, Submergible up to Depths of 1'/30cm
- Drain Hole of Backside can Make Keyboard Dry Faster



**WASHABLE**

**KEYBOARD**



### BL-P-106SG

#### AUDIO CONNECTOR

- 3.5mm Gold Stereo Plugs, Metal Body



### BL-P-112G

#### RCA CONNECTOR

- 1/4" Gold Mono Plug to 3.5mm Jack



### BL-P-119G

#### RCA SPLICE CONNECTOR

- Molded Adapter, Jack to Jack
- Gold



### BL-P-120G

#### RCA SPLICE CONNECTOR

- Molded Adapter Plug to Plug
- Gold



### BL-DSL-F200

#### DSL SPLITTER

- Filters Out DSL Signals to Allow Simultaneous Use of Telephone and DSL Service
- Includes a Pass-Through Jack for Modem, Eliminating the Need for a Double Adaptor
- Superior Design Ensures Compatibility with Cordless Phones



### BL-KR-128

#### CORD UNTANGLER

- Prevents Tangles Cords
- Does Not Affect Sound Quality
- Automatically Rotates to Eliminate Twisted Telephone Cords



### BL-KR-200

#### TELEPHONE ADAPTER

- Modular In-Line Coupler



### BL-KR-202

#### TELEPHONE ADAPTER

- Modular Double Adapter



### BL-KR-203

#### TELEPHONE ADAPTER

- Modular Triplex Adapter



### BL-KR-209-15IV0

### BL-KR-209-25IV0

#### TELEPHONE CORD

- Modular Handset Coiled Cord
- 15" - 25"
- Ivory





## TELEPHONE ACCESSORIES HDMI ACCESSORIES

**BL-KR-425-15**  
**BL-KR-425-25**  
**BL-KR-425-50**

### TELEPHONE CORD

- Modular Straight Line Cord
- 4 Pin Plug to 4 Pin Plug
- 15", 25", 50"
- Ivory



**BL-KR-468**

### TELEPHONE JACK

- 4 Pin Modular Surface Jack with Screws & Stick-On Pad



**BL-KR-468D**

### TELEPHONE DUAL JACK

- 4 Pin Modular Surface Jack with Screws & Stick-On Pad



**BL-KR-468D**

### TELEPHONE DUAL JACK

- 4 Pin Modular Surface Jack with Screws & Stick-On Pad



**HMBL-2009**

### HDMI 19 PIN MALE TO HDMI 19 PIN FEMALE RIGHT ANGLE ADAPTER

- 24K Gold-Plated
- RoHS Compliant
- Blister Packing



**HMBL-2012**

### HDMI FEMALE ADAPTER

- In-Line Coupler
- Allows you to Link Two HDMI Cables
- Blister Packing



**HM-2002-6RA**

### HDMI CABLE A MALE TO A MALE (RIGHT ANGLE)

- 1.4 Version (High Speed with Ethernet)
- Gold-Plated
- 1.4 HDMI Cable
- It can Work for all Previous HDMI 1.3 Devices, also Supports HDMI Ethernet Channel, Audio Return Channel, 3D, 4K Content Types, Deep Color and x.v.Color
- 6'



**HM-2002-12RA**

### HDMI CABLE A MALE TO A MALE (RIGHT ANGLE)

- 1.4 Version (High Speed with Ethernet)
- Gold-Plated
- 1.4 HDMI Cable
- It can Work for all Previous HDMI 1.3 Devices, also Supports HDMI Ethernet Channel, Audio Return Channel, 3D, 4K Content Types, Deep Color and x.v.Color
- 12'





## HDMI ACCESSORIES

### HM-2002-6SWL

180° SWIVEL TYPE, HDMI CABLE  
A MALE TO A MALE

- 1.4 Version (High Speed with Ethernet)
- Gold-Plated
- 1.4 HDMI Cable
- It can Work for All Previous HDMI 1.3 Devices, also Supports HDMI Ethernet Channel, Audio Return Channel, 3D, 4K Content Types, Deep Color and x.v.Color
- 6"



### HM-2002-12SWL

180° SWIVEL TYPE, HDMI CABLE  
A MALE TO A MALE

- 1.4 Version (High Speed with Ethernet)
- Gold-Plated
- 1.4 HDMI Cable
- It can Work for All Previous HDMI 1.3 Devices, also Supports HDMI Ethernet Channel, Audio Return Channel, 3D, 4K Content Types, Deep Color and x.v.Color
- 12"



### HMBL-2002-6

### HMBL-2002-12

1.4 HDMI CABLE

- 24K Gold-Plated Connector
- 1080p Triple Shielded Oxygen-Free with Filter
- Blister Packing



### HMBL-2002-6-4K

### HMBL-2002-12-4K

6' AND 12' HDMI CABLE

- Delivers the best high frequency response for optical resolution using a silver plated conductor
- Maintains a stronger signal, yields superior sonic audio and video using a precision-formulated polyethylene dielectric material
- Quad shielding isolates unwanted outside noise for superior clarity
- Impedance matched twisted pair construction cable reduces cross talk and interference
- Strong outer jacket with strain relief protects against wire damage while consistently transferring high quality audio and video
- Maintains integrity, even when bent with abrasion resistant flexible PVC jacket
- 24K gold plated connectors creates precise contact for low loss signal
- Provides comfort and ease of install with non-slip rubber grip and integrated color-codin



6' and 12'  
With Ferrite Core

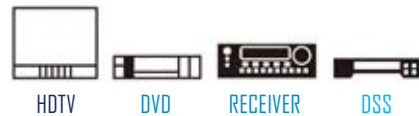

24k  
Gold Plated Connectors

4k  
Triple Shielded  
Oxygen Free



## VGA ACCESSORIES ADAPTERS/POWER STRIPS

### HMC-HM-005-6

#### HDMI MALE TO MICRO-HDMI MALE

- Available in 6', 12'
- Connect a Portable Device such as a Cell Phone, PDA, or Digital Camera with a USB Micro B Connection to your Computer or other USB Device



### BL-VGA-M-M-6G

#### VGA MALE TO VGA MALE CABLE

- Ideal for High-Resolution Monitors (1024 x 768 and Above)
- Triple-Coaxial + Twisted-Pair Wire for Crystal Clear Images
- Impedance Matched @ 75 Ohms for Full Brightness and Vibrant Picture Color
- 6'



### BL-VGA-M-M-12G

#### VGA MALE TO VGA MALE CABLE

- Ideal for High-Resolution Monitors (1024 x 768 and Above)
- Triple-Coaxial + Twisted-Pair Wire for Crystal Clear Images
- Impedance Matched @ 75 Ohms for Full Brightness and Vibrant Picture Color
- 12'



### BL-P-510

#### ADAPTER

- Flat Pin Plug to Round Socket



### BL-P-514

#### GROUND ADAPTER

- 3 Prong Plug to two Prong Outlet, Permits "U" Ground



### BL-P-517G

#### MULTI-ADAPTER

- Adapts to the Plug of your Electronic Product for Use in North America and most South America Outlets
- Does Not Convert Power







# ADAPTERS/POWER STRIPS / WALL OUTLETS

### 13-414

#### 6 OUTLET AC POWER STRIP

- High Impact, Fire-Retardant Plastic Housing
- Outlets: 6 "U" Ground
- Power Supply: 14AWG x 3C SJT
- Length: 3'
- Switch: Lighted Approach Switch
- Max Rating: 15A/120V AC/60Hz/1800 Watts
- **90 joules** Surge Suppressor to Protect Sensitive Electronic Equipment
- For Indoor Use and Dry Locations

## 90 Joules



### 13-6400

#### 6 OUTLET AC POWER STRIP

- High Impact, Fire-Retardant Plastic Housing
- Outlets: 6 "U" Ground
- Power Supply: 14AWG x 3C SJT
- Length: 2'
- Switch: Lighted Approach Switch
- Max Rating: 15A/120V AC/60Hz/1800 Watts
- **400 joules** Surge Suppressor to Protect Sensitive Electronic Equipment
- For Indoor Use and Dry Locations

## 400 Joules



### 14-512

#### 3 OUTLET GROUNDED WALL SOCKET

- For Indoor Use Only
- Use in Dry Conditions
- 110V



### 14-516

#### 6 OUTLET WALL TAP SURGE PROTECTOR

- For Indoor Use Only
- Use in Dry Conditions
- 400V



### 14-519

#### 3 OUTLET SWIVELING GROUNDED WALL SOCKET

- For Indoor Use Only
- Use in Dry Conditions
- 110V

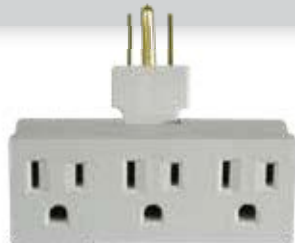



## VGA ACCESSORIES ADAPTERS/POWER STRIPS

### 16-516S

#### 6 OUTLET WALL SOCKET

- High Impact, Fire-Retardant Plastic Housing
- Outlets: 6 "U" Ground
- Max Rating: 15A / 125V AC/60Hz/1875W
- 1000 Joules Surge Suppressor to Protect Sensitive Electronic Equipment
- For Indoor Use Only and Dry Locations
- Can Swivel to Redirect Power and Safely Slide all your Furniture Back
- Creates Extra Space Where you Need it Most



**1000  
Joules**  
15A, 125V, 60Hz & 1875W



### 20-6450-31U

#### POWER STRIP CHARGING CENTER FOR USB ELECTRONICS

- AC Rating: 15A/125V/1875W
- Max. Spike Voltage: 550V
- Clamping Voltage: 550V
- 450J Surge Suppressor to Protect Sensitive Electronic Equipment
- Length: 3'
- USB 2.1A + 1.0A
- For Indoor Use and Dry Locations
- Use for Portable Electronics, Video Game Console



**450  
Joules**  
USB 2.1A + 1.0A



### BL-IBM-104USBC

#### 4 PORTS USB 2.0 HI-SPEED HU

- 1 Upstream and 4 Downstream USB Port Included, Fully Compliant with USB Specification Version 2.0 Hot Plug & Play USB Device
- Half-Transparent Design with Blue LED Power Indicator
- Interface: USB 2.0, Compatible with USB 1.1
- Data Transfer Rate: 1.5Mbps / 12Mbps / up to 480Mbps
- Bus-Power Limit Current Protection: 500mA



**USB 2.0**





# ADAPTERS/POWER STRIPS / WALL OUTLETS

**17-81803U**

**8 OUTLETS AC POWER STRIP WITH TRIPLE USB PORTS**

### APPLICATION

- Suitable for General Electronics, Computers, and Hi Fi Receivers

### OVERVIEW

- Housing Material: PC/ABS
- Color: White

### INPUT

- Max Current: 15A
- Max Voltage: 125V
- Max Power: 1825W
- Nominal Voltage: 110V
- Nominal Frequency: 60Hz
- Resettable Circuit Breaker: 15A
- With ON/OFF Switch

### ENVIRONMENTAL

- Operating Temperature: <45°
- Operating Relative Humidity: <99%
- Storage Temperature: <45°

### SURGE PROTECTION

- Energy Absorption: 1800 Joules
- Clamping Voltage: 400V
- Maximum Spike Current: 36000A

### USB CHARGER

- Allows you to Charge iPhone/iPod and Other Mini Appliance/ iPhone/iPod
- Output: DC 5V/3.1A



**1800**  
**Joules**  
**15A, 125V,**  
**60Hz & 1875W**



**HDMI**<sup>™</sup>  
HIGH-DEFINITION MULTIMEDIA INTERFACE



***2022 CATALOG***





**HD-0102-4**

**1 X 2 MINI SPLITTER**

- Power: 5V DC@1A, 50/60Hz, 5W
- Output Video: HDMI Signal
- Video Amplifier Bandwidth: 3.4Gbps/340MHz
- Interlaced Resolutions (50/60Hz): 480i, 576i, 1080i
- Progressive Resolutions (50/60Hz): 480p, 576p, 720p, 1080p, 4K@30Hz
- Size: 3" x 2" x 0.6" (75 x 48 x 15mm)



**HD-0104-4**

**1 X 4 SPLITTER**

- Supports Full 3D and 4K@30Hz resolution
- Supports 340MHz/3.4Gbps per channel (10.2Gbps all channels)
- Supports 12bit per channel (36bit all channels) deep color
- Supports HDCP 1.4
- Supports uncompressed audio such as LPCM7.1
- Support compressed audio such as DTS, Dolby Digital (including DTS-HD Master Audio™ and Dolby TrueHD).



**HD-0204-4**

**2X4 SWITCHER/SPLITTER**

- Support HDMI 1.4b
- Support 3D
- Support highest video resolution 3840 x 2160/30Hz
- Support 3Gbps data rate for tmds clock up to 300MHz
- Support 8/10/12bit deep color
- Support AWG26 HDMI standard cable: when the resolution is 1080p and below, input up to 15 meters, output to 15 meters; when the resolution is 4K, input up to 8 meters, output up to 8 meters.
- Support single high definition display for multiple sources, such as DVD Players and Stellite Receivers, Digital Projectors, A/V Receivers, Set Top Boxes.



**HD-0208-4**

**2 X 8 SWITCHER / SPLITTER**

- Supports HDMI 1.4b
- Supports 3D
- Supports highest video resolution 3840 x 2160/30HZ
- Supports 3Gbps data rate for tmds clock up to 300MHz
- Supports 8/10/12 bit deep color
- Supports standard AWG26 cable: When the resolution is 1080p and below, input up to 10 meters, output up to 15 meters; When the resolution is 4K, input up to 5 meters, output up to 10 meters
- Supports single high-definition display and multiple output HD signal sources such as DVD Players, A/V Receivers and set-top box
- 110/220V AC Adapter



**Now With Remote Control**





**HD-0301R-4**

**3 X 1 SPLITTER**

- Multi-functional on switching: manual switching, remote switching or automatic switching.
- Supports HDCP pass-through
- Supports high definition resolution 4K@30Hz, 1080p and 3D.
- Supports 300MHz/3.0Gbps per channel bandwidth.
- Supports 12bit per channel (36bit all channels) deep color
- Supports Consumer Electronics Control
- Supports uncompressed audio such as LPCM
- Supports compressed audio such as DTS, Dolby Digital® (including DTS-HD Master Audio™ and Dolby



**HD-0401R-4**

**4 X 1 SWITCHER WITH PIP**

- Support HDMI 1.4
- Support 3.0Gbps per channel bandwidth
- Video resolutions up to 4K x 2K@30Hz, 1080p@120Hz and 1080p 3D @60Hz
- CEC Pass-through
- PIP (Picture in Picture) mode support highest video resolution 1080p 3D@60Hz
- Multifunctional on switching: intelligent or mechanical



**MTV-310**

**1 IN 4 OUT - 4K HD SIGNAL SPLITTER WITH AC POWER ADAPTER**

- Input/output: 1/4
- Frequency range: 47-870MHz
- Gain: 28dB (max)
- Noise figure: < 2dB
- Power supply: INPUT: 100-240V 50/90Hz 0.15A OUTPUT: 5.0V = 1000mA

**28 db**  
Gain





**HD-4K0401R**

**SWITCHER 4 IN 1 OUT**

- HDMI version: HDMI 1.4b
- Support: 4Kx2K (3840x2160), HDCP1.4, 3D, CEC, Blue-Ray 24/50/60fs/HD-DVD/xvYCC, signal retiming
- HDMI resolution: 24/25/30Hz/2160P, 24/50/60Hz 1080p/1080i/720p
- Supports video color format: 24bit/deep color 30bit, 36bit, 48bit
- Supports audio format: DTS-HD/Dolby-trueHD/LPCM7.1/DTS/ Dolby-AC3/SOS HD(HBR)
- Power adapter format: Input: AC (50Hz, 60Hz), 100V-240V;
- Max bandwidth: 340MHz
- Max band rate: 10.2Gbps
- Input/Output TMS signal: 0.5~1.5 Volts p-p (TTL)
- Input/Output DDC signal: 5 Volts p-p (TTL)
- Max working current: 1000mA Output: DC 5V/1A
- Operating Temperature range: (-15°C ~ 55°C)



**AC / DC  
Adapter Included**



**VGA-VASPL-1004**

**VGA SPLITTER 1X4 WITH AUDIO**

- Easy to Use: install in seconds, no need of setting.
- Connects VGA source to four displays at the time.
- Connects stereo audio source to four audio receivers at the time.
- Supports highest video resolution up to 1920 x 1200 and 1080p.
- Supports highest video amplifier bandwidth to 500MHz.



**500MHz, 1080p  
Support**



**HMA-HF-HM**

**HDMI SOCKET TO  
HDMI M-MINI PLUG**

- Commonly Used for TVs and Digital Camcorders to Convert HDMI Cable Ends into a HDMI Mini Connector
- F Adaptor



**HMA-H-HMF**

**HDMI M-MINI SOCKET  
TO HDMI**

- Commonly Used for TVs and Digital Camcorders to Convert HDMI Mini Cable Ends into an HDMI Connector
- F Adaptor



**HM-2012**

**HDMI SOCKET TO  
HDMI M-MINI PLUG**

- Cable Coupler
- Allows you to Link Two HDMI Cables



**HM-2013**

**DVI-D MALE TO HDMI  
FEMALE ADAPTER**

- High Definition Multimedia Interface for HDTV & Home Theater
- 24Kt Gold Plated Connectors for Optimum Signal Transfer
- Dual Link 24 + 1 Pin (DVI-D) to 19 Pin (HDMI) Digital Connectors



**HMBL-2012**

**HDMI FEMALE ADAPTER**

- Cable Coupler
- Allows you to Link Two HDMI Cables
- Blister Packing



**HM-2009**

**HDMI ADAPTER**

- HDMI 19 pin male to HDMI 19 Pin Female Right Angle
- 24K Gold-Plated
- RoHS Compliant



**HMBL-2009**

**HDMI ADAPTER**

- HDMI 19 pin male to HDMI 19 Pin Female Right Angle
- 24K Gold-Plated
- RoHS Compliant
- Blister Packing







### HMM-1005-6

MINI HDMI MALE TO  
HDMI MALE

- 6' / 12'



### VGA-M-M-6

VGA MALE TO VGA  
MALE CABLE

- Ideal for High Resolution Monitors (1024x768 and Above)
- Triple-Coaxial + Twisted-Pair Wire for Crystal-Clear Images
- Impedance Matched @ 75 Ohms for Full Brightness and Vibrant Picture Color
- 6'



### VGA-M-M-12

VGA MALE TO VGA  
MALE CABLE

- Ideal for High Resolution Monitors (1024x768 and Above)
- Triple-Coaxial + Twisted-Pair Wire for Crystal Clear Images
- Impedance Matched @ 75 Ohms for Full Brightness and Vibrant Picture Color
- 12'



### VGA-M-M-25

VGA MALE TO VGA  
MALE CABLE

- Ideal for High Resolution Monitors (1024 x 768 and Above)
- Triple-Coaxial + Twisted-Pair Wire for Crystal Clear Images
- Impedance Matched @ 75 Ohms for Full Brightness and Vibrant Picture Color
- 25'



This cable is used to extend out a VGA monitor which is connected into a desktop PC.

### VGA-M-M-50

VGA MALE TO VGA  
MALE CABLE

- Ideal for High Resolution Monitors (1024 x 768 and Above)
- Triple-Coaxial + Twisted-Pair Wire for Crystal Clear Images
- Impedance Matched @ 75 Ohms for Full Brightness and Vibrant Picture Color
- 50'



This Cable is Used to Extend out a VGA Monitor which is Connected into a Desktop PC.

### VGA-M-M-100

VGA MALE TO VGA  
MALE CABLE

- Ideal for High Resolution Monitors (1024x768 and Above)
- Triple-Coaxial + Twisted-Pair Wire for Crystal Clear Images
- Impedance Matched @ 75 Ohms for Full Brightness and Vibrant Picture Color
- Ferrite Core Eliminates EMI Interference
- Molded Connector Ends with Strain Relief
- 100'





**VGA-F-F**

**FEMALE TO FEMALE ADAPTOR**



- Adapts VGA Cables, Projectors, and Monitors to the Connections you Need
- Screw-Down Terminals Create Secure, Trouble-Free Connections
- Gold-Plated Contacts Ensure Solid Signal Transfer

**VGA-M-2F**

**VGA MALE TO 2 VGA FEMALE CABLE**



- Ideal for High Resolution Monitors (1024x768 and Above)
- Ferrite Core Eliminates EMI Interference
- Molded Connector Ends with Strain Relief
- 12"

**VGA-M-RJ45F**

**VGA TO RJ45 ADAPTER**

- VGA Male / RJ45 Ethernet Port Female
- Computer, DVR, Media Center, Game Consoles



**HDCBL-D102**

**HDMI MALE TO 2-FEMALE SPLITTER CABLE**



- 7.9" (20cm)
- Home Theater Interconnects
- Digital Interface HDMI Audio & Video Cable
- High Definition Multimedia Interface is a New Digital, which will Bring you the Purest Picture and Sound
- Delivers Best High-Frequency Response for Optical Resolution Using Silver-Plated Conductor
- Maintains Stronger Signal that Yield Superior Sonic and Video Accuracy with Precision Formulated, Polyethylene Dielectric Material
- Isolated from Outside Noise for Superior Clarity with Quad-Shielding
- Reduces Cross Talk and Interference Using Impedance-Matched, Twisted-Pair Construction
- Protects against Wire Damage for Consistently High-Quality Audio & Video with Integrated Strain Relief

**HM-DP4K-6**

**6FT DISPLAYPORT MALE TO MALE CABLE**

- 4K Resolution support
- Audio Return Channel (ARC) support





**HM-2002-6-4K**  
**HM-2002-12-4K**  
**HM-2002-25**  
**HM-2002-25-4K**

**HDMI CABLE WITH FTR**

- Gold Connectors
- Available in 6', 12', 25' and 50'
- 1.4V



**HMBL-2002-6**  
**HMBL-2002-6-4K**  
**HMBL-2002-12**  
**HMBL-2002-12-4K**

**HDMI CABLE WITH FTR**

- Gold Connectors
- Available in 6' and 12'
- 1.4V



**HM-2005-3-4K**  
**HM-2005-6**  
**HM-2005-6-4K**  
**HM-2005-9-4K**  
**HM-2005-12-4K**  
**HM-2005-25-4K**  
**HM-2005-50**

**HDMI CABLE**

- Gold Connectors
- Available in 3', 6', 9', 12', 25' and 50'
- 1.4V



**HMBL-2005-6**  
**HMBL-2005-12**

**HDMI CABLE WITH FTR**

- Gold Connectors
- Available in 6' and 12'
- 1.4V





**HM-2007-6**

**HDMI TO DVI CABLE**

- 6'
- 1.4V



**HM-0005-6 (6')**

**HM-0005-12 (12')**

**HDMI CABLE**

- 1.4V



**CV-HMVGA**

**HDMI TO VGA CONVERTER**

- Allows Users with Existing Monitors with VGA to Connect their Devices Via Micro HDMI Port. Besides Extracting Audio Out, it can also get Extra Power for Devices through Micro USB Port



**CV-TCHMUS**

**USB TYPE C TO USB 3.0 + HDMI + USB TYPE C ADAPTER**

- This Adapter is Compliant with TYPE C PD2.0 5Gbps USB3.1 Gen. 1 Standard; it has USB TYPE C Male Input, and Three Outputs: USB 3.0 A Female, HDMI A Female, USB TYPE C Female



**APHI-FA4K-6 (6')**

**APHI-FA4K-12 (12')**

**12FT 4K HDMI CABLE**

- Latest HDMI 2.0 Version
- Compatible with most 3D formats, true 3D gaming and 3D home theater applications
- Ultra-highspeed bandwidth up to 2200Mhz (18GBps)
- Audio return channel
- Supports 32-channel digital audio new formats as Dolby True HD, DTS-HD Master Audio
- Enable video resolution up to 4 times the Full HD: 3840x2160 at 24Hz/25Hz/35Hz, 4180x2160 at 24Hz at 50 to 50 fps
- Deep color from 24-bit to 30-bit, 36-bit, 12-bit (sYCC601 color, Adobe RGB color or Adobe YCC601)
- 4 times larger bandwidth for 4K than 1.4 HDMI
- 19-pin gold plated connectors for a higher speed and more accurate transmission
- Multiple-layer shielding prevents EMI (electromagnetic interference) and RFI (radio frequency interference) from ruining your digital picture
- Braided Nylon Jacket: durable and flexible nylon mesh jacket with environment friendly PVC double layer protection, this ensures a reliable protection of the outer jacket



**6' and 12'**





**HDB-VRCA-HDMI**

**HDMI CONVERTER**

This Mini Converter Composite Signal and L/R Audio Signal to HDMI Upscale to 1080p Output, Making the Image more Stable and Vivid

- Upscale Composite Video to Full HD 1080p
- HDMI Output is Optional at 720p 50/60Hz or 1080p 50/60Hz
- Settings of Input Signal and Output Resolution is Auto-Store when Power On Again
- Long Press 720p/1080p Button for 3 Seconds to Switch Between 4:3 and 16:9 Mode
- Input: Composite x 1, L/R Stereo Audio x 1
- Output: HDMI x 1, DC x 1
- Dimensions: 76x56x22mm
- Weight: 47g



**HDB-HDMI-VRCA**

**MINI HDMI TO AV CONVERTER**

- Hardware Conversion, Plug and Play, No Software Drivers
- Compatible HDMI 1.3
- Support NTSC and PAL Output Formats
- One HDMI Input, AV Output
  - A. Input Terminal: HDMI x 1 Input
  - B. Video Output terminal: VIDEO x 1 Output
  - C. Analog Audio Output Terminals: L / R x 1 Output AV Video Output: 480i, 576i (Optional) Audio Output: Left and Right Channels (L / R)

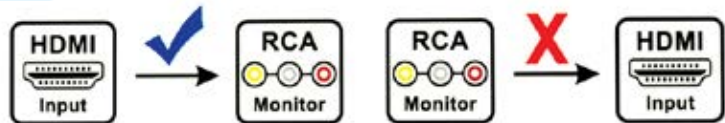

**HDW-HDMI-VRCA**

**HDMI TO AUDIO VIDEO CONVERTER**

- HDMI to AV Converter Connect devices with HDMI output to older devices with Composite/AV connector.
- Supports HDMI up to 1080p@60Hz and HDMI 1.3; It does not support 4k devices.
- HDMI to AV Converter can be switch output standard NTSC/PAL two common formats.
- Compatible for Blu-Ray, HD-DVD, DVD player, HDTV box, HD PVRs, HD DVRs, HD recorder, PS3, Xbox 360, Wii, PC, HD camera.
- Does NOT support 3D. Can not be used as a RCA to HDMI Converter.



**OFC-3 (3")**

**OFC-6 (6")**

**OFC-12 (12")**

**OFC-25 (25")**

**OPTICAL FIBER CABLE**





**CV-MUSBC5**

**USB 2.0 MALE TO RJ45 FEMALE ETHERNET 10/100 MBPS NETWORK LAN ADAPTER CABLE FOR APPLE MACBOOK, LENOVO, THINKPAD, DELL, SONY, SAMSUNG, ACER, ASUS, AND OTHER LAPTOP BRANDS**

- USB 2.0 A to Ethernet Port Adapter
- Enables Internet Connection Via USB Port
- Powered by USB Port. No External Power Adapter Required
- Half/Full Duplex 10/100 Mbps Operation
- Self-Adapting 10 Mbps or 100 Mbps Network Adapter
- Compliant to USB Interface Version 1.0/1.1/2.0
- Compatible with Windows 98SE ME/2000/2003/XP/Vista/Windows7



**CV-HDIDSP**

**HDMI FEMALE TO DISPLAYPORT MALE ADAPTER**

HDMI Adapter to DisplayPort allows for transmission of both audio and video from a supported device to a monitor, HDTV, projector or any other device with DisplayPort.

It supports up to 4K resolution as well as Audio Return Channel (ARC) to manage additional audio devices, such as audio bars, through a single cable.

- 4K Resolution support
- Audio Return Channel (ARC) support



**HDC-VGA35**

**HDMI CONVERTER**

- VGA + R/L Audio to HDMI
- Input Video Signal: 0.5-1 Volts p-p
- External Power Supply: 5V DC @ 2A
- Output Video: HDMI 1.2a
- Vertical Frequency Range: 50/60Hz
- Max. Power Consumption: 5W
- Multi-Voltage: 100-240V, 50-60Hz, 0.5A





## HDC-HDMI35

### HD VIDEO AUDIO CONVERTER

- No Need to Install Drivers
- Portable, Flexible, Plug and Play
- Low Power No Need for a Power Supply
- Output the Audio Synchronized with Video
- High Output Bandwidth, Capable of Supporting 3840 x 2160 @ 30Hz



## HD-DIGI-ANA

### HD VIDEO PROCESSING

- Converts S/PDIF or Optical (Toslink) to Analog R/L Audio Signal
- Supports 2 Channels LPCM Digital Audio Only
- Supports Sampling Rate at 32, 44.1, 48 and 96KHz
- Input: S/PDIF x 1, Toslink x 1
- Output: L/R Audio x 1, 3.5mm Audio x 1
- Dimensions: 76 x 56 x 22mm
- Weight: 47g



## HD-DIGI-ANAD

### DIGITAL TO ANALOG CONVERTER

- Converts S/PDIF or Optical (Toslink) to Analog R/L Audio Signal
- Supports 2 Channels LPCM Digital Audio Only
- Supports Sampling Rate at 32, 44.1, 48 and 96KHz
- Input: S/PDIF x 1, Toslink x 1
- Output: L/R Audio x 1, 3.5mm Audio x 1
- Dimensions: 76 x 56 x 22mm (2.99" x 2.20" x 0.87")
- Weight: 47g (0.1 Lbs)
- Built-In Conversion Module for Movies with Enhanced Sound Programming





**APTOS-DF6**

**APTOS-DF12**

**DIGITAL TOSLINK AUDIO CABLE**

- Fiber Optic Cable
- Connect your Audio System to your HDTV
- Premium Toslink Audio
- 24K Gold-Plated Connector
- Braided Nylon Jacket
- PMMA Fiber Core
- 6FT. & 12FT. Length



**24KT**  
Gold-Plated  
RCA Connectors

**HDM-3DI4RP-75**

**HDMI CABLE WITH BOOSTER**

- Copper
- 75 Ft.



**HDM-3DI4RP-100**

**HDMI CABLE WITH BOOSTER**

- Copper
- 100 Ft.

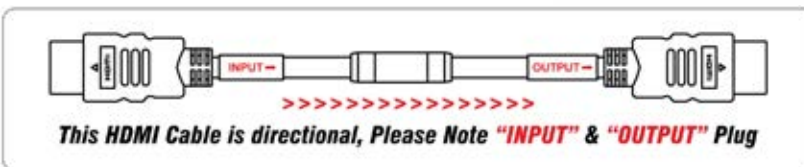





**ROUTER CONNECTION**

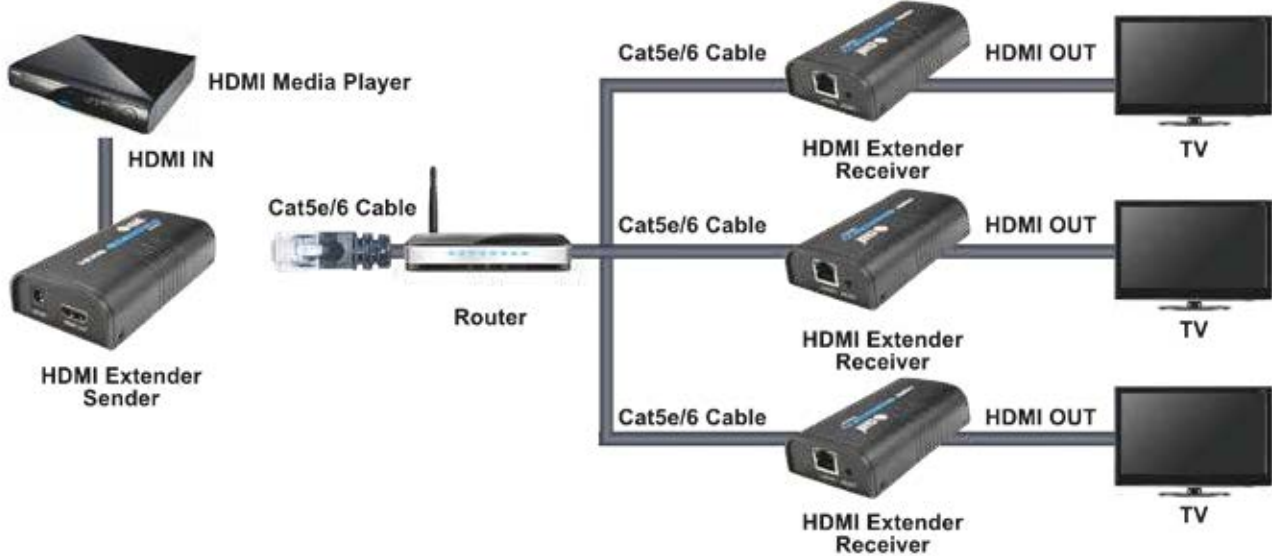

**LAN CONNECTION**

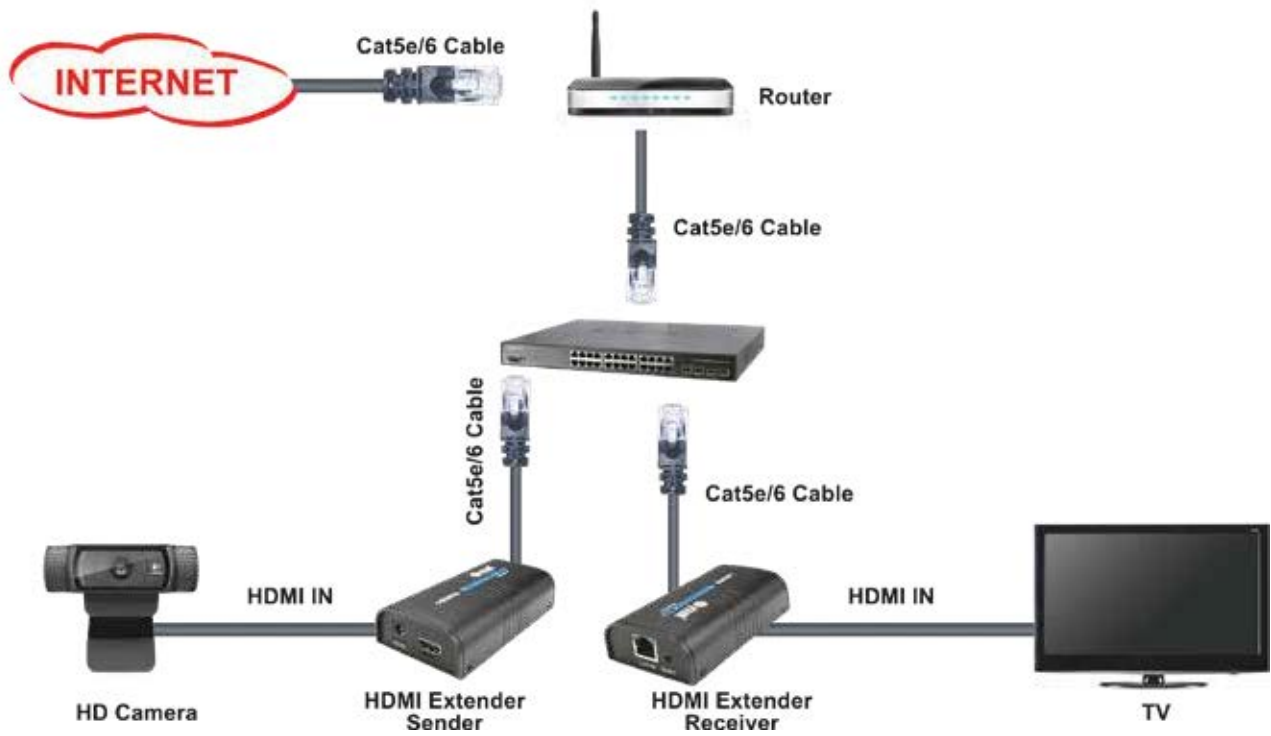



**HD-EX120SS**

**HDMI IP EXTENDER OVER SINGLE CAT5E/6**

- Round Glass Lens Size: 5 Inch
- Optical Power: 3D
- Super Bright 60 Ultra-Efficient SMD LEDs
- Low Power Consumption: 8W
- Adjustable Arm
- Arm Length: 16"
- Voltage: AC 110-120V, 60Hz
- Luminous Flux: 760 Lumen
- 60Pcs SMD LEDs, 8W



**HD-EX250SR**

**HDMI IP EXTENDER OVER SINGLE CAT5E/6**

**Extra long range and Power regulator**

- Power Supply: 2x 5V DC/1A
- Supports Resolutions: 480i/60Hz, 480p/60Hz, 576i/50Hz, 560p/50Hz, 720p/50/60Hz, 1080i/50/60Hz, 1080p/50/60Hz
- Working Temperature: -10°C~60°C
- Link Connector (Sender/Receiver): UTP/STP CAT5e/6
- Power Consumption: 3W (Max) Each
- Relative Humidity: 20%~90%
- Dimensions: 4.3"x2.3"x1.0" (110x58x26mm)
- Weight: 0.53Lbs (0.239Kg)



**SENDER / RECEIVER**





## HMWP-HDHDM

### 2 PORT HDMI WALL PLATE

- Supports 4K, 3D, ARC
- Supports all HDMI Functions Including High Dynamic Range (HDR) Video, 4K, UHD, 3D, 48-Bit Deep Color and Audio Return Channel (ARC)
- DUAL PORT: 2 HDMI Ports with Gold-Plated Contacts
- NO SOLDERING: Coupler Style Connectors Provide Easy Connections On Front and Rear Back of the Wall Plate



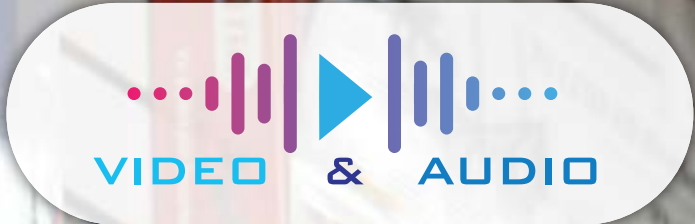

**2022 CATALOG**



HD Digital Antenna  
KHF-1109HD

na

HD Digital TV Antenna

Digital TV Antenna  
KHF-1500A-HD

Curved TV LCD LED Bracket  
NA6-3770E2H

na

**HD-180MBK**

**HEADPHONE MICROPHONE  
COMPUTER SET - BLACK**

- Speaker Type: Ø30mm Dynamic
- Frequency Response: 20-20kHz
- Impedance: 32 Ohms
- Sensitivity: 100dB
- Max. Input Power: 1KmW
- Plug: Ø3.5mm (5/32")
- Microphone: Condenser
- For use with Internet



**CD-3500**

**DELUXE HI-FI HEADPHONES**

- Speaker Type: Ø40mm Anisotropic
- Frequency Response: 20-20kHz
- Impedance: 32 Ohms
- Sensitivity: 105dB
- Max. Input Power: 100mW
- Cord Length: 2.7M
- Plug: Ø6.3mm (1/4") Gold Adapter
- Digital



Full Ear Style



**HP-150V**

**DELUXE HI-FI HEADPHONES**

- Speaker: 40mm
- Driver Unit: 15mm Mylar Speaker
- Frequency Response: 20-20kHz
- Impedance: 32 Ohms
- Sensitivity: 105dB
- Max Input Power: 1000mW
- Plug: 6.3mm



**MCM-4275**

**TV LCD/LED BRACKET**

- Fixed LCD/LED Wall Mount
- Width Adjustable to hold TV's from 42"-75"
- Pan: 360°
- Tilt: ±15° Up and Down
- Max Pattern: 31.5" x 19.7" (800x500mm)
- Variable Drop-Pole: up to 80cm (31.5") of Adjustment
- Solid, Heavy Gauge Cold Rolling Steel Construction
- Supports up to 65Kgs (143lbs)
- Color: Black
- Easy to Install Mounting Hardware Included

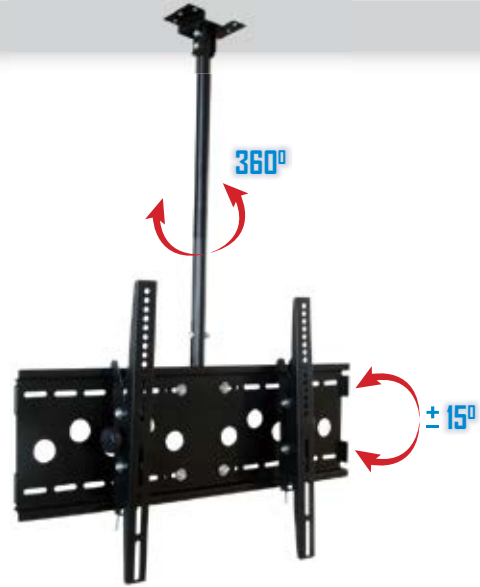

**MFLR-3770**

**PUBLIC MOBILE TV CART**

- Fixed LCD/Plasma mount
- Width Adjustable to hold TV's from 37" to 70"
- With four Wheels
- Supports up to 40Kg (88LBs)
- Easy to install
- Mounting Hardware included
- Color: Black



37" up to 70"



**MFLR-3770 A&B**

**PUBLIC MOBILE TV CART**

- Fixed LCD/Plasma Mount
- Width Adjustable to hold TV's from 37" to 70"
- With Four Wheels
- Supports up to 40Kg (88LBs)
- Easy to Install
- Mounting Hardware Included
- Color: Black



37" up to 70"



**MFLMS-3770**

**PORTABLE TRIPOD TV LCD/LED MOUNT**

- For Flat Panel Televisions (37"~70")
- Solid, Heavy Gauge Steel Construction
- Supports up to 35kgs (77Lbs)
- Tilt: -8°~0°
- Range of Height: 48.8"~74" (1240~1880mm)
- Easy to Install
- Mounting Hardware Included



**MFLRE-3770S**

**TV FLOOR STAND**

- Fixed LCD / Plasma Mount
- Max Mount Pattern: 400 x 600mm (15.7" x 23.6")
- With Four Wheels
- Tilt: ±10°
- Supports up to 40Kg (88Lbs)
- For Plasma/LCD TV 37"~70"
- Easy to Install
- Mounting Hardware Included
- Color: Black



**MSE-1443F**

**TV LCD/LED BRACKET**

- Built-in level
- Fixed LCD/LED wall mount
- Maximum TV weight: 66lbs (30kgs)
- Mounting profile: 1.1" (27 mm)
- Width adjustable to hold TV's from 14" up to 43"
- VESA Standard: 75x75, 100x100, 200x100, 200x200
- Easy to install



14" up to 43"

66 Lbs



**MTE-1443T**

**TILT TV LCD/LED MOUNTING BRACKET**

- Fixed LCD/LED wall mount
- Maximum TV weight: 66lbs (30kgs)
- Width adjustable to hold most TV's from 14" ~ 43"
- VESA Standard: 75x75, 100x100, 200x100, 200x200
- +12° ~ -12° Tilting
- Mounting profile 2.1" (53 mm)
- Easy to install



14" up to 43"

**MT-2070**

**FIXED LCD/LED WALL MOUNT**

- Width Adjustable to hold TV's from 20" to 70"
- Maximum TV Weight: 60Kgs (132 lbs)
- Low Profile Design, only 2.36" (60mm) against Wall
- Mounting Holes up to 24.40" (620mm) x 16.14" (410mm)
- Free Bubble Level System
- Solid, Heavy Gauge Steel Construction

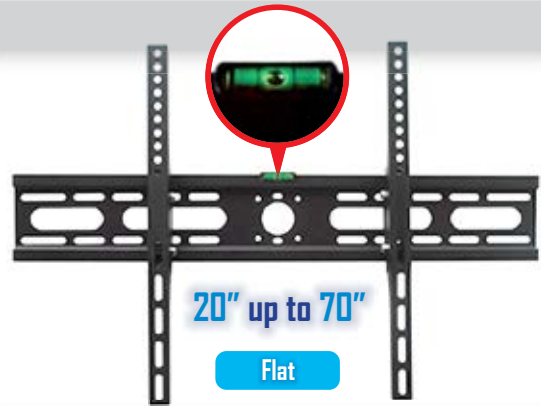

**MSE-3260F**

**FIXED LCD/LED WALL MOUNT**

- Maximum TV Weight: 88 lbs
- Mounting Profile: 27mm
- Width Adjustable to hold TV's from 32" to 60"
- VESA Standard: 200x200, 400x200, 300x300, 400x400
- Easy to Install



**MSE-3770F**

**FIXED LCD/LED WALL MOUNT**

- Maximum TV Weight: 40Kgs (88lbs)
- Mounting Profile: 27mm
- Width Adjustable to hold TV's from 37" to 70"
- VESA Standard: 75x75, 100x100, 200x200
- Easy to Install

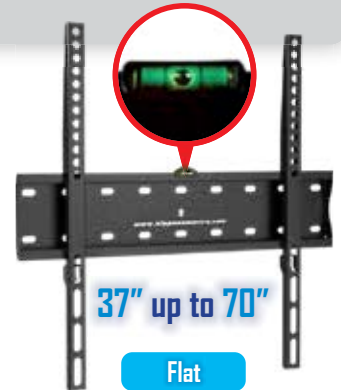

**MSE-60100F**

**TV LCD/LED BRACKET**

- Fixed TV LCD/LED Mount
- For Flat Panel Televisions (60" ~ 100")
- Solid, Heavy Gauge Steel Construction
- Supports up to 75kgs (165 lbs)
- Easy to Install
- Mounting Hardware Included

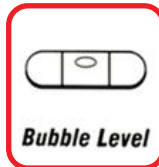
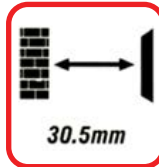

**MTE-3260T**

**FIXED LCD/LED WALL MOUNT**

- Maximum TV Weight: 88lbs
- Mounting Profile: 53mm
- 12° ~ -12° Tilting
- Easy to Install
- Width Adjustable to hold TV's from 32" to 60"
- VESA Standard: 200x200, 400x200, 300x300, 400x400

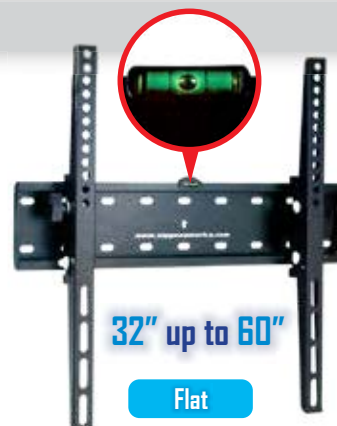



**MRE-1343DRT**

**FULL MOTION TV LCD/LED BRACKET**

- Full Motion LCD/LED wall mount
- Maximum TV weight: 44lbs (20kgs)
- Width adjustable to hold TV's from 13" up to 43"
- VESA Standard: 75x75, 100x100, 200x100, 200x200
- +5° ~ -12° tilt;
- +90° ~ -90° swivel
- Mounting profile: 2.4" ~ 14.3" (60 ~ 364 mm)
- Easy to install



**MRE-1343RT**

**FIXED LCD/LED WALL MOUNT**

- Maximum TV Weight: 20Kgs (44lbs)
- Width Adjustable to hold TV's from 13" to 43"
- VESA Standard: 75x75, 100x100, 200x200
- +5° ~ -12° tilt, +90° ~ -90° Swivel, +3° ~ -3° Level Adjustment
- Mounting Profile: 60~190mm
- Easy to Install



**MRE-1460SART**

**TV WALL BRACKET**

- Width Adjustable to hold TV from 14" ~ 60"
- Maximum TV Weight: 66 Lbs
- Swivel: 270°
- Tilt: 30°
- Profile: 10.2" (260mm)
- Cable Management, Rotatable Mount
- Color: Black

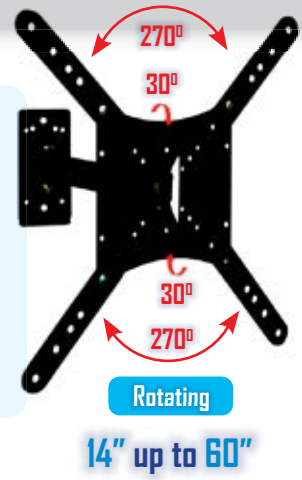

**MSE-2360SART**

**TV WALL BRACKET**

- Pan: +/- 45°
- Tilt: +/- 20°
- Maximum TV Weight: 66lbs
- Mounting Profile: 3.5" ~ 7.9"
- Cable Management, Rotatable Mount
- Width Adjustable to hold TV's from 32" to 60"
- Color: Black



**MSE-2360DRT**

**TV WALL BRACKET**

- Width Adjustable to hold TV's from 23" to 60"
- Maximum TV Weight: 66lbs
- Pan: +/- 90°
- Tilt: +/- 20°
- Profile: 3.5" ~ 15.7"
- Cable Management, Rotatable Mount
- Color: Black

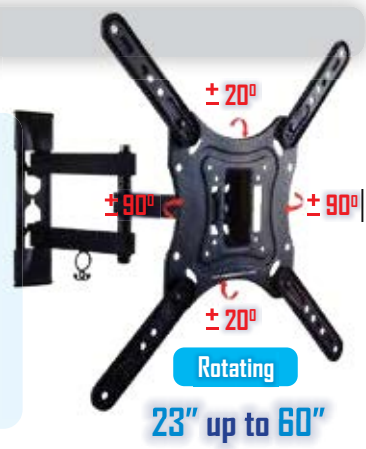

**MTE-2560CR**

**TV LCD/LED CORNER MOUNT**

- Articulated LED/LCD TV Wall Mount
- For Flat Panel Televisions (25"~60")
- Supports up to 66 Lbs
- Solid, Heavy Gauge Steel Construction
- Level Gauge Built-In for Easy One Step Install
- Up-Down Inclination Adjustable: 15°
- Swivels from Left/Right for Viewing from Horizontal 120°
- Hinged Arm Extends TV 110MM TO 485mm of Wall
- Color: Black

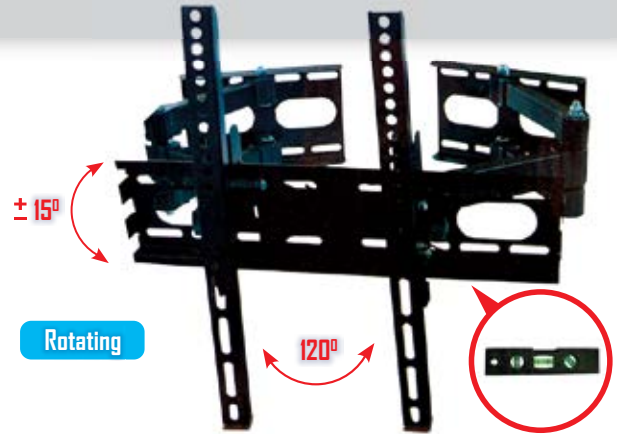

**MA-3063**

**FIXED LCD/PLASMA MOUNT**

- Width Adjustable to hold TV's from 30" to 60"
- Solid, Heavy Gauge Steel Construction
- Color: Black
- Easy to Install
- Adjustable Width between 110 and 450cm
- Vertical Inclination Adjustable +/- 10°
- Maximum TV Weight: 60Kgs (132lbs)



**MTE-3770T**

**TILT TV LCD/LED MOUNTING BRACKET**

- Fixed LCD/LED wall mount
- Maximum TV weight: 77lbs (35kgs)
- Width adjustable to hold most TV's from 37" ~ 70"
- VESA Standard: 200x200, 300x200, 300x300, 400x200, 400x400, 600x400
- +0° ~ -8° Tilting
- Mounting profile 0.8" (25 mm)
- Easy to install

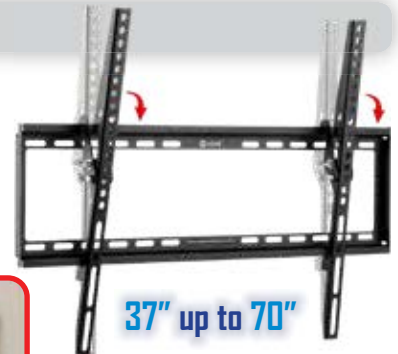
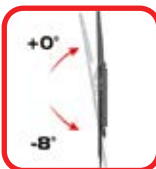

**MTE-3625DVD**

**FIXED UNIVERSAL DVD WALL MOUNT**

- Tempered Black Glass Shelf
- Glass Dimensions: 14.2" x 9.8" x 0.2" (360x250x5mm)
- Supports up to 17.6Lbs (8 Kgs)
- Cable Board for Hiding Wires
- Assemble Guide Included



**WM-SB-850**

**SOUNDBAR BRACKET**

- Material: Aluminum
- Speaker Hole Dimension: M4, M5, M6, 1/4"
- Profile: 15mm



**MA-3270DB**

**FULL MOTION TILT SWIVEL ARTICULATING DUAL ARM TV MOUNT**

- Full motion LCD/LED wall mount
- Maximum TV weight: 88lbs (40kgs)
- Width adjustable to hold most TV's from 32" up to 70", Flat & Curved
- VESA Standard: 75x75, 100x100, 100x150, 100x200, 150x100, 150x150, 200x100, 200x200, 300x200, 300x300, 400x200, 400x300, 400x400
- Mounting profile 2.4" ~ 18.4" (62 - 468 mm)
- +10° ~ -15° tilt
- +60° ~ -60° swivel
- +3° ~ -3° level adjustment
- Easy to install



Rotating  
32" up to 70"



**MA-3770S**

**FULL MOTION TILT SWIVEL ARTICULATING SINGLE ARM TV MOUNT**

- Full motion LCD/LED wall mount
- Maximum TV weight: 77lbs (35kgs)
- Width adjustable to hold most TV's from 32" up to 70", Flat & Curved
- VESA Standard: 75x75, 100x100, 100x150, 100x200, 150x100, 150x150, 200x100, 200x200, 300x200, 300x300, 400x200, 400x300, 400x400, 600x400
- Mounting profile 3" ~ 17.2" (77 - 437 mm)
- +10° ~ -15° tilt
- +90° ~ -90° swivel
- +3° ~ -3° level adjustment
- Easy to install



Rotating  
32" up to 70"



**MON-CL 1327-SN**

**MONITOR DESK MOUNT**

- Fit Screen Size: 13"~27"
- Weight Capacity: 22 lbs (10kg)
- VESA Compatible: 75 x 75, 100 x 100
- Tilt Range: +45°~-45°
- Swivel Range: +45°~-45°
- Screen Rotation: +180°~-180°
- Installation: Grommet, Clamp
- Suggested Desktop Thickness: Clamp: 10~88mm; Grommet: 10~80mm
- Cable Management: Yes



**MON-CL 1327-DB**

**DUAL MONITOR DESK MOUNT**

- Fit Screen Size: 13"~27"
- Weight Capacity (per screen): 22 lbs
- VESA Compatible: 75x75, 100x100
- Tilt Range: +45°~-45°
- Swivel Range: +15°~-15°
- Screen Rotation: +180°~-180°
- Installation: Grommet, Clamp
- Suggested Desktop Thickness: Clamp: 10~88mm; Grommet: 10~80mm
- Cable Management: Yes

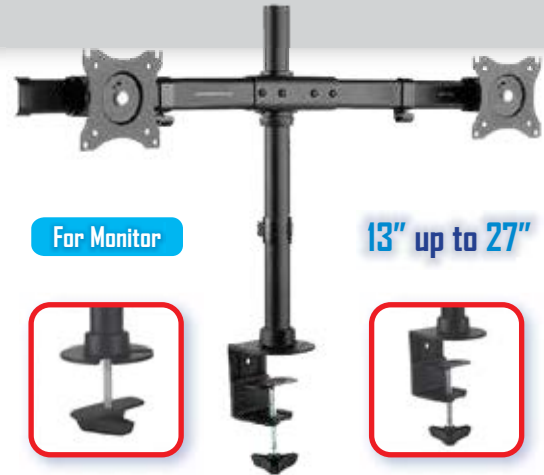

**MSF-4380US**

**ULTRA SLIM TV LCD/LED MOUNTING BRACKET**

- Fixed TV LCD/LED wall mount
- Maximum TV weight: 88lbs (40kgs)
- Width adjustable to hold most TV's from 43" up to 88" Flat & Curved
- VESA Standard: 200x200, 300x200, 300x300, 400x200, 400x300, 600x300
- Mounting profile 0.7" (18 mm)
- Easy to install



**MAE-3260**

**FULL MOTION TILT SWIVEL ARTICULATING SINGLE ARM TV MOUNT**

- Full motion LCD/LED wall mount
- Maximum TV weight: 77lbs (35kgs)
- Width adjustable to hold most TV's from 32" up to 60"
- VESA Standard: 200x200, 300x300, 400x200, 400x300, 400x400
- Mounting profile 2.5" ~ 16.8" (63 - 427 mm)
- +10° ~ -15° tilt
- +90° ~ -90° swivel
- +3° ~ -3° level adjustment
- Easy to install



32" up to 60"



**MAE-3770CRV**

**CURVED TV LCD/LED BRACKET**

- Fixed LCD/LED Wall Mount
- Maximum TV Weight: 35Kgs (77lbs)
- Mounting Profile: 63-427mm
- Width Adjustable to hold TV's from 37" to 70"
- VESA Standard: 200x200, 300x300, 400x200, 400x400, 600x400
- Easy to Install



Rotating  
37" up to 70"

**Curved TV LCD/LED Bracket**



**MLETT-1370-L**

**TABLETOP TV STAND**

- Fixed LCD / Plasma Mount
- VESA Compatibility: 75 x 75mm~800 x 400mm (3" x 3"~31.5" x 15.7")
- Supports up to 50Kg (110Lbs)
- For Plasma/LCD Flat Screen TV 13"~70"
- Easy to Install
- Mounting Hardware Included
- Color: Black



13" up to 70"

**MLETT-2370-L**

**TABLETOP TV STAND**

- Supports up to 50Kg (110Lbs)
- Width adjustable to hold most 23"~70" Flat & Curved TV's
- Easy to Install
- Mounting Hardware Included
- Color: Black



23" up to 70"

**MCPJ-912T**

**PROJECTOR CEILING AND WALL MOUNT**

- Weight Capacity: 44 lbs
- Profile: 16.9" - 25.6"
- Tilt Range: +15° ~ -15°
- Swivel Range: +8° ~ -8°
- The Maximum Distance between any Two Holes is 12"
- The Minimum Distance between any Two Holes is 9"
- The Mounting Holes on Projector must be between 9" - 12"
- Easy to Install

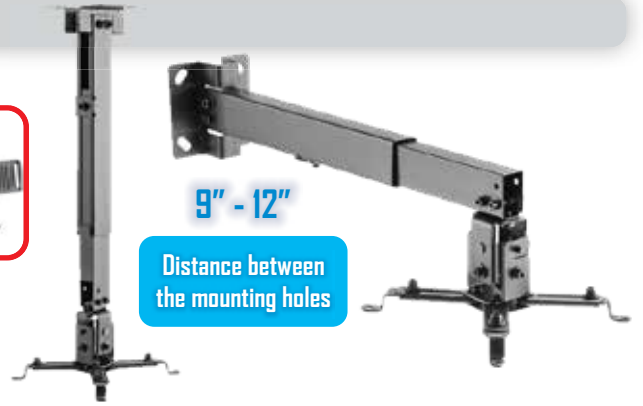
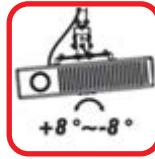

9" - 12"  
Distance between the mounting holes

**MLETT-3255-S**

**TABLETOP TV STAND**

- Fixed LCD / Plasma Mount
- Max Mount Pattern: 400 x 400mm (15.7" x 15.7")
- Cable Management
- Supports up to 30Kg (66Lbs)
- For Plasma/LCD TV 32"~55"
- Easy to Install
- Mounting Hardware Included
- Color: Black



32" up to 55"

**MLETT-3760-L**

**TABLETOP TV STAND**

- Fixed LCD / Plasma Mount
- Max Mount Pattern: 600 x 400mm (23.6" x 15.7")
- Cable Management
- Supports up to 30Kg (66Lbs)
- For Plasma/LCD TV 37"~60"
- Easy to Install
- Mounting Hardware Included
- Color: Black



37" up to 60"

**RCN-503**

**TV REMOTE CONTROL 3 WAY**

- Consolidates up to 3 Remotes
- Compatible with Today's Most Popular Brands of TV, Satellite, VCD & DVD



**RCN-504**

**TV REMOTE CONTROL 4 WAY**

- Consolidates up to 4 Remotes
- Compatible with Today's Most Popular Brands of TV, Satellite, VCD & DVD



**RCN-506**

**TV REMOTE CONTROL 6 WAY**

- Consolidates up to 6 Remotes
- Compatible with Today's Most Popular Brands of TV, Satellite, VCD & DVD



**ZNA-110**

**UNIVERSAL TV REMOTE**

- Available in Bulk
- Poly Bag Packing



**RCN-LGA567**

LG REPLACEMENT HDTV, LCD, LED, 3D, SMART TV REMOTE CONTROL

- No programming or pairing required
- Requires x2 AAA batteries
- Farther transmitting distance
- Stable performance
- Size: 1.90" x 9.25" x 1"

**Compatible Models:**

32L85800, 39L85800, 42L85800, 47L85800, 47L85800-UG, 47L86100, 50L86100, 50L86100-UG, 55L85800, 55L86100, 55L86100-UG, 55U88200, 55U88200-UH, 60L86100, 60L86100-UH, 65U89200, 65U89200-UC, AK873756523, AK873756567 and more!



**RCN-SAM809**

SAMSUNG REPLACEMENT HDTV, LCD, LED, 3D, SMART TV REMOTE CONTROL

- No programming or pairing required.
- Requires x2 AAA batteries.
- Soccer mode button.
- Farther transmitting distance.
- Stable performance.
- Size: 1.85" x 9" x 1.5".

**Compatible Models:**

UN32F4300AF, UN32F4300AFXZP, UN32F4300AFXZ, UN32F4300AG, UN32F4300AGXPE, UN32F4300AGXZS, UN32F4300AH, UN32F4300AHXPA, UN32F4300AK, UN32F4300AKXZL, UN40FH5303FX, UN40FH5303FXZP, UN40FH5303FXZ, UN40FH5303GX, UN40FH5303GXPE, UN40FH5303GXZD, UN40FH5303GXZS, UN40FH5303HX, UN40FH5303HXPA, UN40FH5303KX, UN40FH5303KXZL, UN40FH6203FX, UN40FH6203FXZ, UN40FH6203GX, UN40FH6203GXPE, UN40FH6203GXZS, UN40FH6203HX, UN40FH6203HXPA, UN40FH6203KX, UN40FH6203KXZL, UN46FH5303FX, UN46FH5303FXZP, UN46FH5303FXZ, UN46FH5303GX, UN46FH5303GXPE, UN46FH5303GXZD, UN46FH5303GXZS, UN46FH5303HX, UN46FH5303HXPA, UN46FH5303KX, UN46FH5303KXZL, UN46FH6203FXZ, UN46FH6203GX, UN46FH6203GXPE, UN46FH6203GXZS, UN46FH6203HX, UN46FH6203HXPA, UN46FH6203KX, UN46FH6203KXZL, UN50FH5303FX, UN50FH5303FXZP, UN50FH5303FXZ, UN50FH5303GX, UN50FH5303GXPE, UN50FH5303GXZD, UN50FH5303GXZS, UN50FH5303HX, UN50FH5303HXPA, UN50FH5303KX, UN50FH5303KXZL and more!



**RCN-ST904BL**

6 IN 1 UNIVERSAL REMOTE CONTROL FOR TV & STREAMING DEVICES

- Consolidates up to 6 remotes
- Super easy one-click remote for streaming
- Requires x2 AAA batteries
- Size: 2" x 7.25" x 1"

Control all your streaming devices

6 in 1 For TV & Streaming Devices



Your Nippon America universal remote control is compatible with most brands of infrared remote-controlled components manufactured after 1990. Some of the well-known brands are compatible with this remote. The complete list of brands is found on the Code List inside the package. This remote operates certain compatible brands out the package and programming may not be needed.



# UNIVERSAL REMOTE CONTROLS

## RCN-C931BL

### ONE WIPE REMOTE

- Ideal for Hospitals, Schools & Hotels
- Easy Setup with Auto Code Search
- Security Cover for Batteries
- Close Caption & Sleep Button
- Consolidates up to 3 Remotes
- Compatible with Today's Most Popular Brands



## ZNA-413BL

### CONTROL 4 DEVICES WITH 1 REMOTE

- Works with all major brands.
- Easy to setup and use.
- LED Backlight for use in the dark.
- Dedicated menu navigation buttons.
- Requires 2xAAA batteries.



The Ultra Smooth Surface of This Remote Allows you to Clean and Sanitize in Just 1 Wipe!



TV's



DVD



Cable/Satellite



VCR



Digital Box Converter

## RCN-SB906BL

### 6 IN 1 UNIVERSAL REMOTE

- 6 in 1, for TV1, TV2, Cable, Satellite, VCR, AUX
- Consolidates up to 6 Remotes
- Compatible with Today's Most Popular Brands
- Streaming Player + Sound Bar Compatible!



## RCN-ROK280

### ROKU REMOTE CONTROL REPLACEMENT

- No programming or pairing required
- Requires x2 AAA batteries
- Farther transmitting distance
- Stable performance
- Size: 1.5" 5.5" x 0.5"

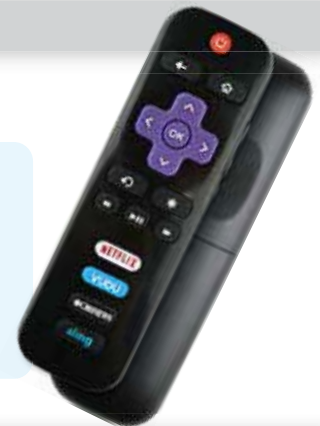

## APTOS-DF6

### APTOS-DF12

#### DIGITAL TOSLINK AUDIO CABLE

- Fiber Optic Cable
- Connect your Audio System to your HDTV
- Premium Toslink Audio
- 24K Gold-Plated Connector
- Braided Nylon Jacket
- PMMA Fiber Core
- 6FT. & 12FT. Length



**24KT**  
Gold-Plated  
RCA Connectors



**KF-235**

**DISTRIBUTION AMPLIFIER**

- Gain Control
- FM Trap/ 24DB Cable Amplifier
- NA Boosters



**MTV-196**

**DISTRIBUTION AMPLIFIER**

- Gain Control
- Low Noise
- 54-550MHz
- High Output Power
- 30dB Gain
- 2 Way Output



**NB-810 (110V)**

**4 WAY AMPLIFIER**

- 10dB Gain
- 50-400MHz Bandwidth



**MTV-310**

**1 IN 4 OUT - 4K HD SIGNAL SPLITTER**

- Input/Output: 1/4
- Frequency Range: 47-870MHz
- Gain: 28dB (Max)
- Noise Figure: < 2dB
- Power Supply:  
INPUT: 100-240V 50/90Hz 0.15A  
OUTPUT: 5.0V = 1000mA



**GTS-061**

**3 WAY SELECTOR**

- TV / VCR / CVD / Satellite Receiver / Video Camera Game selector.
- Audio (Stereo L+R) & Video 3 Way Selector.
- Three Audio / Video Inputs - Let you connect three audio / Video sources.
- Standard RCA - Type Phono connectors - Make connections simple.
- Turn control Knob - lets you quickly set the input source for each TV.
- Baseband design for reducing RF interference.
- Stereo compatible.



**GTS-090-8**

**RF MODULATOR**

- Converts A/V RCA Signal to "F" Type Coaxial 75 Ohm Signal
- RF Modulator
- Converts "RCA" type output to "F" Type Output, to be used for TV's without "RCA" Type Inputs



**GTS-090-20**

**AUTO TV SWITCH AV > RF**

- RF Modulator
- Automatically Switch from AV Device to Home TV when AV Device System is Turned On
- Shielded Coaxial Cables for a Clear Picture, Free from Outside Signal Interference





## VIDEO ACCESSORIES

### HD-ATSC-4

#### DIGITAL TV CONVERTER

- Converts Over-the-Air Digital Television Signals for Use with Standard TVs
- Receives Free Over-the-Air Digital TV Signals
- Record Live TV
- Full HD 1080P / 1080i / 720p / 480p
- Aspect Ratio: 16:9 & 4:3
- AV, HD Outputs
- USB Multimedia Player
- Cable Loop Through
- On-Screen Electronic Program Guide Support
- Favorite Channel List
- Parental Control Function
- Supports Closed Caption
- Full Function Remote Control



### RSS-1045-IR

#### WIRELESS IR REMOTE EXTENDER REPEATER TRANSMITTER RECEIVER BLASTER EMITTER

##### Receiver(RX):

- Transmission Frequency: 433.92MHz±200KHz Superherodyne
- IR Signal Transmitting:≤5m
- Power Input: DC5V/100mA, or Two Batteries of AA LR6 1.5V(Not Included)
- Horizontal Barrier-Free Transmission Distance between the Transmitter and Receiver: ≤200m

##### Transmitter (TX):

- Transmission Frequency: 433.92MHz±500KHz Superherodyne
- Carrier Frequency: 38KHz/56KHz
- IR Signal Transmitting: ≤10m
- Power Input: DC5V/100mA, or Two Batteries of AA LR6 1.5V(Not Included)



### GTS-090-10

#### VERTICAL OR HORIZONTAL DESIGN WITH REMOVABLE BASE

- Auto Selection for A/V or Antenna Inputs
- RF Converter
- Converts "RCA" Type Output to "F" Type Output, to be used for TV's without "RCA" Type Inputs



### BL-HD-MIMAD

#### MHL HDTV SMART ADAPTER

- Connect your MHL-Enabled Phone to your High Definition TV or Computer Monitor
- Requires Standard HDMI Cable and Micro USB Charging Cable
- Simply Add Plug between MHL Adapter and your Device as shown
- 5-pin to 11pin Adapter Plug allows you to use your MHL Smart Adapter with the Latest Galaxy and MHL Compatible Devices



**F-29**

ANTENNA

- Universal Rabbit Ear Design
- Dual
- 10" Collapsed
- 31" Extended
- Nickel Finish



**F-29A**

F TYPE ANTENNA

- Universal Rabbit Ear Design
- Dual
- 10" Collapsed
- 31" Extended
- "F" Push On



**F-32**

INDOOR ANTENNA

- VHF/UHF
- Dual
- 10" Collapsed
- 31" Extended



**F-33N**

RABBIT EAR ANTENNA

- VHF/UHF
- Dual
- 10" Collapsed
- 31" Extended
- Nickel Finish



**F-33A**

ANTENNA

- Universal Rabbit Ear Design
- Dual
- 10" Collapsed
- 31" Extended
- Nickel Finish
- "F" Push On N-223 Type Cable



**F-33N81**

ANTENNA

- Universal Rabbit Ear Design
- Dual
- 10" Collapsed
- 31" Extended
- Nickel Finish
- "F" Type Female Mounted on Base
- VHF/UHF
- W / F 81 Connection



## KF-112HD

### INDOOR UHF/VHF/FM ANTENNA

- Enhances Local TV Channels Reception, Perfect for Satellite/Cable Backup & Digital TV Signal
- Adjustable Super-Long 38" Chrome-Plated Antenna Mast
- Telescopic Dipoles w/Brass UHF LOOP
- Coaxial Cable Connection to any TV Brands
- Clearly Receives all Local Channels
- Superior Signal Reception



## KF-3002HD

### INDOOR HDTV ANTENNA AMPLIFIED

- Terrestrial HDTV Broadcast Compatible
- State Of The Art 2 Stage VHF Amplifiers
- Low Noise High Gain Control-Super Efficient Noise Reduction Circuitry
- Super-Efficient Noise Reduction Circuitry
- Highly Sensitive VHF Elements And High Gain Directional UHF Element
- Superior FM Reception
- Tilt Adjustment
- LED Power Indicator



## ST-802

### HDTV ANTENNA

- 6 Position Picture Switch
- 4 Section
- 32" Extended



## KF-1204

### HDTV INDOOR ANTENNA

- Gain: VHF -4 ~ 0dBi; UHF 1 ~ 3dBi
- Operation Frequency: VHF 174 ~ 230MHz; UHF 470 ~ 810MHz
- Output Impedance: 75 Ohm
- Standing Wave Ratio: 1.5 : 1



## KF-1309-HD

### HDTV INDOOR ANTENNA

- Innovative Flat, Paper-Thin Antenna Design
- High Gain/Low Noise Digital TV Signal Reception
- Multi-Directional Signal Reception
- Easy Installation, No Tools and No Assembly Required



## KF-1109HD

### HD DIGITAL TV INDOOR ANTENNA

- Frequency Range: VHF 47-240MHz; UHF 470-862MHz
- Gain: 4dBi (Max)
- Impedance: 75Ω
- Noise Figure: ≤ 2dB
- Connector Type: F-male/IEC
- Dimensions: 10 3/4" x 3"

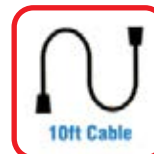

## KF-1335-HD

### HD DIGITAL ANTENNA

- Working Frequency: VHF 47~240MHz, UHF 470~862MHz
- V.S.W.R.: ≤2.0
- Typical Antenna Gain: 5 dBi
- Polarization: Linear
- Impedance: 75 Ohm
- Material of Coaxial Cable: RG 2.5C2V, L=10 Feet
- USB Cable: 0.8M
- Connector Type: F Male
- Reception Range: 35 Miles
- Size: 300 x 280 x 1.1 mm



## KF-1500A-HD

### HD DIGITAL ANTENNA WITH BOOSTER

- Working Frequency: VHF 47~240MHz, UHF 470~862MHz
- V.S.W.R.: ≤2.0
- Typical Antenna Gain: 5 dBi
- Polarization: Linear
- Impedance: 75 Ohm
- Material of Coaxial Cable: RG 2.5C2V, L=10 Feet
- USB Cable: 0.8M
- Connector Type: F Male
- Reception Range: 35 Miles
- Size: 300 x 280 x 1.1 mm
- Signal Amplifier Booster



## KF-1650A-HD

### OUTDOOR HD DIGITAL TV ANTENNA AMPLIFIER KIT (WITH SIGNAL AMPLIFIER BOOSTER)

- VHF 47~240 MHz, UHF 470~862 MHz
- V.S.W.R.: ≤ 2
- Typical Antenna Gain: 30dBi with Amplifier
- Impedance: 75 Ohm
- RG6 Coax Cable: Cu 1.5C - 2V, L=10M
- Connector Type: F Male
- Reception Range: 60 Miles
- Size: 22.2" x 11" x 0.8" (565 x 280 x 20mm)



## W-15-259

### HIGH GAIN SIGNAL AMPLIFIER

- Amplifies HDTV, VHF, UHF, and FM Signals
- Gain Control Gives you the Ability to Fine-Tune Reception for Each Station
- On/Off FM Trap Cuts FM Interference so it doesn't Disrupt Television Reception
- Dual Outputs for Connecting up to Two Separate TV or Receivers
- Gold-Plated Connectors Help Improve Signal and Reduce Interference
- Frequency: 54-806 MHz
- FM trap: > 20dB @ 100 MHz
- Gain: 15dB at Outdoor Amplifier; Up to 6dB at Indoor Amplifier
- Gain Control: 0-10dB



**Dual Output Indoor Amplifier**



**W-3000**

**HIGH GAIN AND LOW NOISE INLINE AMPLIFIER KIT**

- When your TV Picture Freezes or Appears Blotchy, it is usually Caused by a Weak Signal, our Signal Amplifier can Improve Poor Picture Quality Caused by Weak Signals
- Less than 25dB, Power by DC 5V 500mA, Enhances the Performance of Passive Antennas in Challenging Areas of Reception
- Noise Figure: Less than 2dB, Preserves Signal Purity with Extremely Low-Noise (ELN) Circuitry



**100-240V  
INPUT**

**WM-4**

**ANTENNA ACCESSORIES**

- Wall Mount 4"



**WM-6**

**ANTENNA ACCESSORIES**

- Wall Mount 8"



**WM-CH-418**

**ANTENNA BRACKET CHIMNEY MOUNT**

- Y" Type Configuration
- Provides 4-inch Clearance from Chimney
- Stainless Steel Straps
- Includes two 18-foot Stainless Steel Straps ideal for Chimneys up to 12 Linear Feet around
- Use this to Mount 1" to 1-1/4" O.D. Masts
- Two Mounts per Kit - Made of 1-1/4" Wide X 12 Gauge Galvanized Steel



Includes 18 Feet of Galvanized Straps to Wrap around your Chimney for mounting your TV Antenna Mast (Masts from 1.00 to 1.25 inch O.D.) through two straight bolt clamps. Hardware included as shown. Professional Grade, Sturdy. (Mast not Included)



**WM-19**

**DIGITAL ANTENNA J-POLE MOUNT**

- 180° Adjustability
- Color: Black
- Pipe Diameter:  $\varnothing$  1" (25mm)
- Pipe Thickness: 0.06" (1.5mm)
- Net Weight: 1Kg (2.2lbs)

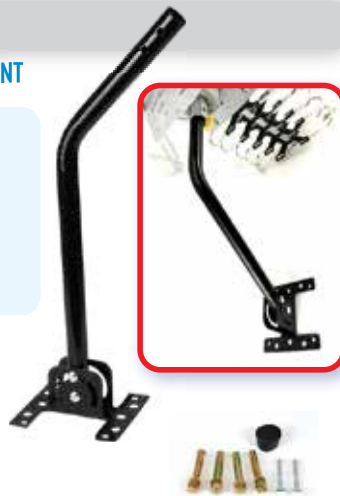

**STA-150C**

**VHF/UHF/FM ANTENNA**

- Antenna With Booster



**WV-870**

**TV REMOTE CONTROLLED ROTATABLE ANTENNA**

- Infrared Remote Control for Long Distance Reception and Anti-Interference
- Receives VHF-UHF Channels
- Rotation: Max 360°
- Frequency: 45-910 MHz
- VHF Gain: 18dB
- UHF Gain: 28dB
- Standard Wave: <4
- Impedance: 75Ω
- Power: 3W
- Working Voltage: 110V/60Hz
- Rotation Speed: 4r/m
- Built-In Low Noise Circuit
- Built-In High Gain Booster



**MST-516**

**TRI-3137**

**ANTENNA ACCESSORIES**

- 5', 16 Gauge (MST-516) Antenna Mast
- (TRI-3137) Antenna Tripod



**UVV633**

VHF/UHF ANTENNA

- Channels: 2-69, 4-7dB VHF Gain, 3-5dB UHF Gain
- 75/300 Ohm
- 12 Elements



**UVV1342**

VHF/UHF ANTENNA

- Channels: 2-69, 7-11dB VHF Gain, 6-9dB UHF Gain
- 75/300 Ohm
- 19 Elements

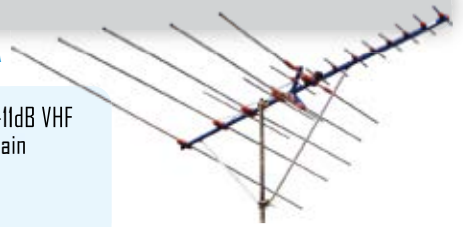

**UVV922**

VHF/UHF ANTENNA

- Channels: 2-69, 4-7dB VHF Gain, 3-5dB UHF Gain
- 75/300 Ohm
- 15 Elements

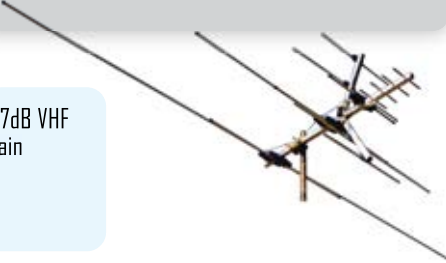

**UVV933**

VHF/UHF ANTENNA

- Channels 2-69, 8-14dB VHF Gain, 3-5dB UHF Gain
- 75/300 Ohm
- 15 Elements

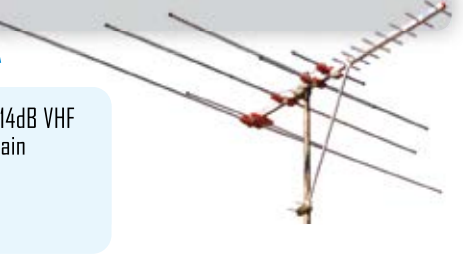

**U-W19**

HIGH DEFINITION SIGNAL ANTENNA

- Terrestrial HDTV - Broadcast Compatible
- Reception Channel 13~62
- Impedance 75 Ohms



**U-W25**

HIGH DEFINITION SIGNAL ANTENNA

- Terrestrial HDTV - Broadcast Compatible
- Reception Channel 13~62
- Impedance 75 Ohms



**UVV-HD600**

SUPER HIGH GAIN UHF/VHF TV ANTENNA

- Reception Channel Ech 2~69
- Impedance: 75 Ω
- Terrestrial HDTV Broadcast Compatible
- Double Packed for UPS Shipping



Easy Installation



**UVV-HD1300**

SUPER HIGH GAIN UHF/VHF TV ANTENNA

- VHF Channels 2-13
- UHF Channels 14-69
- Frequency Range: 174-603 MHz
- Range: 65 Miles
- Double Packed for UPS Shipping

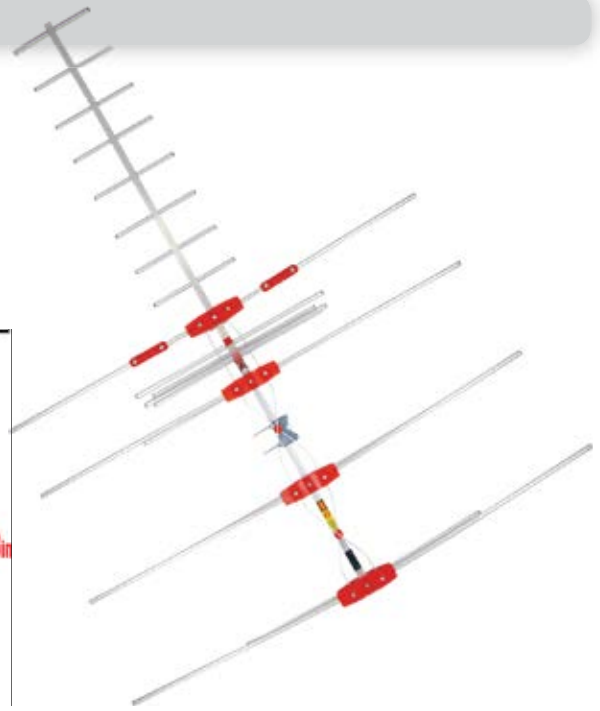

**65 MILE RANGE**

**TERRESTRIAL HDTV BROADCAST COMPATIBLE**

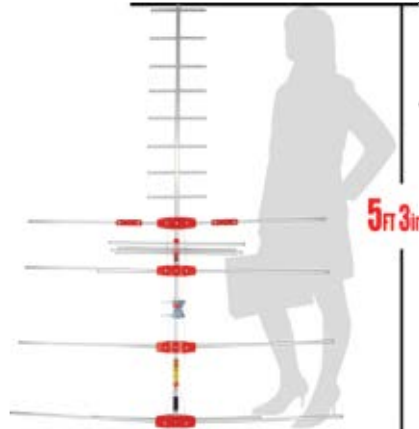

**F-90**

ANTENNA

- FM Dipole Indoor Antenna

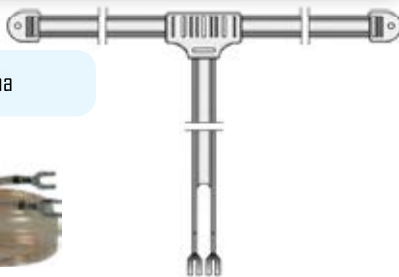

**F-21A (3 Section)**

**F-21B (4 Section)**

**F-21C (4 Section)**

ANTENNA

- 11" Knocked Down and 30" Extended (F-21A)
- 8" Knocked Down and 24" Extended (F-21B)
- 11" Knocked Down and 37" Extended (F-21C)

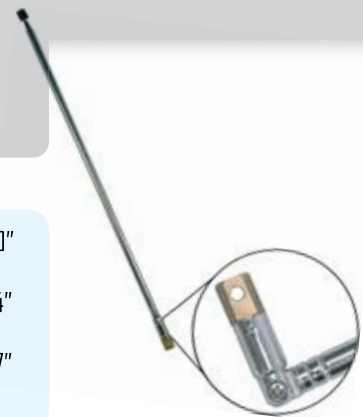

**W-6000**

VHF/UHF COLOR TV BOOSTER

- High Power: 135dB
- Dual Impedance: 750hm
- Dual Voltage Input: AC 110V/220V Switchable
- Power Consumption: 5.5 Watts Max.
- Outdoor Antenna Booster



**W-7000**

VHF/UHF COLOR TV ANTENNA BOOSTER

- High Power: 135dB
- Gain Control: 0-10dB Variable
- Dual Impedance: 750hm, F Connector
- Dual Voltage Input: AC 110V/220V Switchable
- Power Consumption: 5.5 Watts Max.
- Outdoor Antenna Booster



With F Type Inputs for a More Secure Connection!

**N-375**

COAXIAL CABLE WALL PLATE WITH SINGLE CONNECTOR

- 300-75 Ohm
- Aluminum



**N-380**

F TYPE "PUSH-ON" CONNECTOR

- 300-75 Ohm



**N-919**

OUTDOOR VHF/UHF TRANSFORMER

- Weather Resistant with Rubber Boot & Spade Terminals

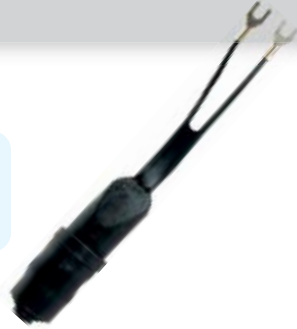

**N-919A**

OUTDOOR VHF/UHF TRANSFORMER

- Weather Resistant with Rubber Boot

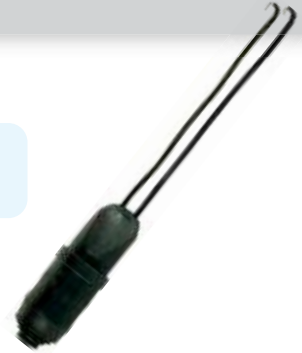

**N-267**

INTERIOR VHF/UHF TRANSFORMER

- 75 Ohm Input
- Twin Lead
- 300 Ohm Output



**NB-420**

8 WAY SPLITTER

- 5~1,000MHz
- Zinc
- Die Cast with Screws
- 8 Way Splitter



**FSP10-230**

SURGE PROTECTOR

- F-Type Lighting Surge Protector Male to Female
- Insertion Loss: MAX-4.5dB
- Bandwidth from DC to 3 GHz
- Connectors: F Male to F Female



**N-1000** (Zinc)

**N-1000G** (Gold)

**SPLITTER**

- 2 Way
- 5-1,000MHz 75 Ohm CATV Signal "F" Splitter
- 75Ohm Input, 75 Ohm UHF/VHF Output



**N-1001** (Zinc)

**N-1001G** (Gold)

**SPLITTER**

- Mini 2 Way
- 5-1,000MHz 75 Ohm CATV Signal "F" Splitter
- 75Ohm Input, 75 Ohm UHF/VHF Output



**N-1003** (Zinc)

**N-1003G** (Gold)

**SPLITTER**

- 3 Way
- 5-1,000MHz with Screws
- 75Ohm Input, 75 Ohm UHF/VHF Output



**N-1004**

**SPLITTER**

- 4 Way
- 0-1,000MHz
- 75Ohm Input, 75 Ohm UHF/VHF Output
- Metal with Screws



**N-1005** (Zinc)

**N-1005G** (Gold)

**SPLITTER**

- 4 Way
- 5-1,000MHz
- With Screws
- Gold



**N-1006** (Gold)

**SPLITTER**

- 6 Way
- 5-900MHz
- With Screws
- Gold



**KL-812A**

**2-WAY SPLITTER**

- 5 - 2,400 MHz
- Power Pass to all Ports
- Silver



**KL-813A**

**3-WAY SPLITTER**

- 5 - 2,400 MHz
- Power Pass to all Ports
- Silver



**KL-814A**

**4-WAY SPLITTER**

- 5 - 2,400 MHz
- Power Pass to all Ports
- Silver



**F-59**

**TWIST-ON CONNECTOR**

- With Separated Ferrule for RG-59



**F-71B**

**UNIVERSAL COUPLER**

- Twist-on Male to Male "F"



**NF-3**

**ADAPTER**

- Female to RCA Female to "F" Adapter



**NF-4**

**ADAPTER**

- Female to RCA Male to "F" Adapter



**NF-18**

**ADAPTER**

- Twist-on Angled Male to "F" to Female Adapter



**NF-35**

**ADAPTER**

- Male to RCA Female to "F" Adapter

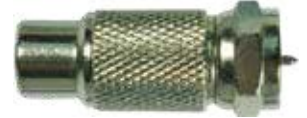

**NF-56**

**NF-56G (Gold)**

**NF-66 (Gold)**

**CONNECTOR**

- Twist-on Connector for RG-6
- Twist on Connector for RG-59



**NF-81**

**NF-81G (Gold)**

**CONNECTOR**

- Female Splice Connector for Coaxial Cable



# SPLITTERS

**F-56CMP BLU** (Blue)

**F-56CMP BLK** (Black)

**F-56CMP RED** (Red)

**SPLITTER**

- F Type Compression Connector for RG-6 Cable



**F-59CMP BL** (Blue)

**F-59CMP BK** (Black)

**F-59CMP RD** (Red)

**F-59CMP-GR** (Green)

**SPLITTER**

- F Type Compression Connector for RG-59 Cable



**FCP-56CMP**

**CONNECTOR**

- F Compressor Connector Copper



**FLM-56CP**

**CONNECTOR**

- Twist-On Self Locking Connector
- X 50 Locking Mechanism



**F-81**

**F-81G** (Gold)

**CONNECTOR**

- Female Splice Connector with Nut & Washer
- Available in Gold



**F-82**

**CONNECTOR**

- 3 Way "F" Type Adapter
- 2 Females & 1 Male



**F-83**

**CONNECTOR**

- Female RCA Chassis Connector for Coaxial Cable with Teflon



**F-85**

**ADAPTER**

- 3 Way "F" Type Adapter
- 3 Females



**F-87**

**CONNECTOR**

- 4 Way "F" Type Adapter
- 4 Females



**PAL-911**

**ADAPTER**

- PAL Male to "F" Female



**F-62**

**CONNECTOR**

- Female Chassis Mount
- UHF Connectors



**NF-12**

**ADAPTER**

- Double Female Adapter
- UHF



**PL-258**

**CONNECTOR**

- Coaxial Plug Reduced for RG-58
- UHF



**PL-259**

**CONNECTOR**

- Coaxial Plug
- UHF



**PL-259D**

**CONNECTOR**

- Deluxe Silver Plated Coaxial Plug with Heat Resistant Gold Tip & White Teflon Core



**NF-2**

**CONNECTOR**

- Male to "F" Female
- BNC Connectors



**NF-32 (For RG-6)**

**CONNECTOR**

- Twist-On Male
- BNC Connectors



**NF-33**

**CONNECTOR**

- Male Twist-On
- For RG-59
- BNC Connectors



**NF-34**

**CONNECTOR**

- Twist-On Male
- For RG-6
- BNC Connectors



**NF-52**

**CONNECTOR**

- Female to "F" Male
- BNC Connectors



**NF-56W**

**CONNECTOR**

- Twist-On
- For RG-6
- F Connectors



**NF-58**

**CONNECTOR**

- 3 Piece Male Crimp
- For RG-58
- BNC Connectors



**NF-19**

**CONNECTOR**

- Double Female Adapter
- BNC Connectors



**NF-32CMP BK (Black)**

**NF-32CMP BLU (Blue)**

**NF-32CMP RD (Red)**

**CONNECTOR**

- Twist-On Male
- BNC Type Compression Connector for RG-6 Cable



**NF-33CMP BK (Black)**

**NF-33CMP BLU (Blue)**

**CONNECTOR**

- Twist-On Male
- F Type Compression Connector for RG-59 Cable



**NF-34CMP BLU (Blue)**

**CONNECTOR**

- Twist-On Male
- F Type Compression Connector for RG-58 Cable



**NF-53**

**CONNECTOR**

- Female to "F" Female
- BNC Connectors



**NF-75**

**CONNECTOR**

- Double male Adapter
- BNC Connectors



**NF-1**

**ADAPTER**

- Push-On Male to Female Adapter
- Push-On F male to F Female Adaptor



**NF-6 (Gold)**

**CONNECTOR**

- Twist-On Connector for RG-59



**NF-8**

**CONNECTOR**

- Male to RCA Female
- BNC Connectors



**NF-14**

**CONNECTOR**

- Male to Double Female "T" Connector
- BNC Connectors



**NF-16**

CONNECTOR

- Female to RCA Male
- BNC Connectors



**NF-69**

CONNECTOR

- For RG-11U with Separate 1/5" Ferrule



**NF-73**

CONNECTOR

- 3 Female "T" Adapter
- BNC Connectors



**NF-74**

CONNECTOR

- 3 Male "T" Adapter
- BNC Connectors



**NF-78**

CONNECTOR

- Double Female Chassis Mount
- BNC Connectors



**P-101TRA**

PLUG

- 1/4" Right Angle Plug
- For: Speaker Cable (12 Gauge & UP) Microphone Cable ( All )



**P-100T (Mono)**

**P-102T (Stereo)**

PLUG

- 1/4" Plug



**P-101T**

**P-101T-G (Gold)**

PLUG

- 1/4" Mono Plug
- Metal Body



**P-103T**

PLUG

- 1/4" Stereo Plug
- Metal Body



**P-103T-G (Gold)**

PLUG

- 1/4" Stereo Plug
- Metal Body





**P-104T (Mono)**

**P-104T (Stereo)**

**PLUG**

- 3.5mm Plug



**P-107VTN**

**PLUG**

- 3.5mm Video Plug



**P-222L**

**1/4" RIGHT ANGLE MONO  
PLUG ADAPTER TO RCA  
FEMALE**

- Nickel-Plated Metal Housing
- Solder Type



**J-236**

**POWER JACK**

- DC Power Jack 2.1 TO 5.5mm



**J-238**

**POWER JACK**

- DC Power Jack 2.5 TO 5.5mm



**P-193**

**FEMALE STEREO**

- 1/4" Female



**P-195**

**FEMALE STEREO**

- 1/4" Female Stereo
- Silver
- Chassis Mount



**PY-243MN**

**ADAPTER**

- "Y" Adapter for RCA plug 1/4"
- Mono



**PY-243ST**

**ADAPTER**

- "Y" Adapter for RCA Plug 1/4"
- Stereo



**P-264**

**COUPLER**

- Metal 1/4" Coupler



**P-265**

**COUPLER**

- Metal 3.5mm Coupler



**P-2155WJ**

**12V DC JACK AND SOCKET  
POWER ADAPTER**

- For a wide range of applications including replacing or repairing existing connectors
- Voltage rating: 36V DC
- Current rating: 1A
- Operating Temperature: -20°C to +70°C



PLUGS / JACKS

**P-106M** (Mono)

**P-106S** (Stereo)

**P-106S** (Stereo-Gold)

PLUG

- 3.5mm Stereo Plug



**P-108**

PLUG

- 1/4" Stereo Plug to 3.5mm Mono Jacks Left and Right



**P-110**

**P-110G** (Gold)

PLUG

- 3.5mm Stereo Plug 1/4" Jack



**P-111** (Stereo)

**P-112** (Mono)

PLUG

- 1/4" Plug 3.5mm Jack



**P-117S** (3.5mm Stereo)

**P-118** (1/4" Mono)

**P-118S** (1/4" Mono)

JACK

- In-Line Jack



**P-180 BLU**

**P-180 RED**

PLUG

- Professional 1/4" Color Coded



**P-181 BLK**

PLUG

- Professional 1/4" Color Coded
- All Colors have Gold Tip



**P-217**

PLUG

- 3.5mm Stereo to RCA Plug



**P-220**

JACK

- RCA Jack to Double RCA Jack



**P-237** (5 x 5 x 2.1mm)

**P-238** (5 x 5 x 2.5mm)

**P-239** (5.5 x 2.9mm)

PLUG

- DC Power Plug



**P-246**

JACK

- 1/4" Stereo Plug to 3.5mm Stereo Double Jack



**P-248 (Mono)**

**P-249 (Stereo)**

PLUG

- 1/4" Plug to Double 1/4" Jacks



**P-250**

JACK

- 3.5mm Stereo Plug to 3.5mm Stereo Double Jack



**P-221**

JACK

- RCA Plug to Double RCA Jack



**P-221G**

JACK

- RCA Plug to Double RCA Jack
- Gold Tips



**P-222**

JACK

- 1/4" Mono Plug to RCA Jack



**P-222C**

JACK

- 1/4" to RCA Jack Adaptor



**P-223**

JACK

- 3.5mm Mono Plug to RCA Jack



**GM-101 (Mono)**

PLUG

- 1/4" Shielded Right Angle Plug



**P-227 (Mono)**

**P-228 (Stereo)**

PLUG

- 3.5 mm Female to RCA Male



**P-113**

JACK

- RCA Female to Double RCA Male



**P-115 BLK**

**P-115 RED**

PLUG

- RCA Plug



**P-116B**

**P-116R**

**JACK**

- RCA Jack



**P-119**

**JACK**

- Molded Adapter
- RCA Jack to RCA Jack



**P-119G**

**JACK**

- Molded Adapter
- RCA Jack to RCA Jack
- Gold Ends



**P-120G**

**RCA PLUG TO RCA PLUG**

- Gold & Black Finish



**P-125 BLK**

**RCA PLUG WITH TAIL**

- Black Color



**P-125 RED**

**MONO RCA PLUG WITH TAIL**

- Red Color



**P-126 RED**

**JACK**

- RCA Jack



**P-127**

**P-127G (Gold)**

**PLUG**

- RCA Plug Metal Type



**P-192**

**JACK**

- 2 RCA Jack to 2 RCA Jack



**P-242**

**JACK**

- 3.5mm Stereo Plug to RCA Jack



**P-243 (Stereo)**

**P-247 (Mono)**

**JACK**

- 1/4" Plug to Double RCA Jack



**P-244**

**JACK**

- 3.5mm Stereo Plug to RCA Double Jack



**P-119BL**

**JACK**

- Molded Adapter
- RCA Jack to RCA Jack



**P-276**

**3 RCA TO 3 RCA COUPLER**

- Plastic Handle



**P-245**

**JACK**

- 3.5mm Mono Plug to Double RCA Jack



**P-253**

**JACK**

- RCA Plug to 3.5mm Mono Double Jack



**Q-119**

**JACK**

- Jack to Jack
- RCA Coupler
- Gold



**Q-120**

**PLUG**

- Plug to Plug
- RCA Coupler
- Gold

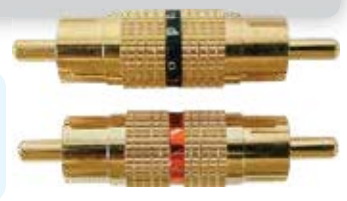

**Q-121**

**JACK**

- Right Angle Plug to Jack
- RCA Coupler
- Gold



**DIN-P5**

**PLUG**

- 5 Pin Plug



**DIN-J6**

**JACK**

- 6 Pin Jack



**DIN-P8**

**PLUG**

- 8 Pin Plug



**ZP-RCA-PG**

**GOLD-PLATED RCA PLUG**

- Set of Two



**LP-M**

**AUDIO LEVEL**

- Mono
- L Pads
- 8 Ohms



**CC-5 (for RG-59)**

**CC-6 BLK (for RG-6)**

**CLIP**

- Nylon Clip



**TG-300R-1235G**

**DVD MOTOR**

- CW
- $\leq 105$  mA
- $2900 \pm 105$  rpm



**NB-317 (Mono)**

**JACK**

- 1/4" Jack
- (2P~8P)
- 1/4" Phone Jack



**NB-403**

**JACK**

- 1/4" Mono Jack
- Open Circuit



**NB-404**

**JACK**

- 1/4" Mono Jack
- Closed Circuit



**NB-405**

**JACK**

- 1/4" Stereo Jack
- Closed Circuit



**NB-406**

**JACK**

- 1/4" Stereo Jack
- Open Circuit



**NB-407**

**JACK**

- 1/4" Jack, 3 Conductor
- Closed Circuit



**NB-408**

**JACK**

- 1/4" Jack, 3 Conductor
- Open Circuit



**KR-220 (Ivory)**

**FLAT TELEPHONE CABLE**

- 4 Conductors
- Flat Type
- Color Coded
- 20 GA
- 1000' Spool



**RG-6DK**

**USA STANDARD COAXIAL CABLE**

- 1000 Feet
- Aluminum Braid and Foil
- 1.02CCS (Electric Conductivity 15%) +4.8FPE+ALUMINUM FOIL+96\*0.12ALM
- 75 OHM OD:7.0MM



**RG-6 BLK**

**RG-6 WHT**

**CABLE**

- Coaxial Cable 1000'



**RG-58 (Copper Braid)**

**RG-59 BLK**

**CABLE**

- Coaxial Cable 1000'



**RG-59AL-BLK**

**RG-59AL-WHT**

**CABLE**

- Coaxial Cable 1000'
- Aluminium Braid



**CABLE 12CL2-500**

**IN-WALL SPEAKER CABLE**

- 2 x 12 AWG
- Copper Clad Aluminum Conductors
- White PVC
- CL2 Rated for In-Wall Installation
- Length: 500'



**CABLE 14CL2-500**

**IN-WALL SPEAKER CABLE**

- 2 x 14 AWG
- Copper Clad Aluminum Conductors
- White PVC
- CL2 Rated for In-Wall Installation
- Length: 500'



**CABLE 16CL2-500**

**IN-WALL SPEAKER CABLE**

- 2 x 16 AWG
- Copper Clad Aluminum Conductors
- White PVC
- CL2 Rated for In-Wall Installation
- Length: 500'



- Connect your Speakers to your A/V Receiver or Amplifier with this 2-Conductor Speaker Wire
- Pair with Banana Plugs, Spade Tips, or Bent Pin Connectors for Professional Custom Installations
- Tough, yet Flexible White Insulated Jacket is Color Coded for Polarity
- Rated CL2 for In-Wall Use





## SPEAKER CABLES

### IS-SP-10-500CL

#### SPEAKER CABLE

- 10 Gauge
- 500 Ft.



### IS-SP-12-500CL

#### SPEAKER CABLE

- 12 Gauge
- 500 Ft.



### IS-SP-14-1000CL

#### SPEAKER CABLE

- 14 Gauge
- 1000 Ft.



### IS-SP-16-1000CL

#### SPEAKER CABLE

- 16 Gauge
- 1000 Ft.



### IS-SP-18-1000CL

#### SPEAKER CABLE

- 18 Gauge
- 1000 Ft.



### CPW-RVV-152-300

#### RVV CABLE

- 2 x 14 AWG
- Copper Clad Aluminum Conductors
- Black PVC
- Rated Voltage 300/500V
- Length: 300'

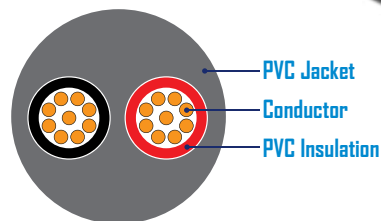



# SPEAKER CABLES

## IS-SP-14-1000BR

### SPEAKER CABLE

- 14 Gauge
- 1000 Ft.
- 305 M.



## IS-SP-16-1000BR

### SPEAKER CABLE

- 16 Gauge
- 1000 Ft.
- 305 M.



## IS-SP-18-1000BR

### SPEAKER CABLE

- 18 Gauge
- 1000 Ft.
- 305 M.



## IS-SP-20-1000BR

### SPEAKER CABLE

- 20 Gauge
- 1000 Ft.
- 305 M.



## CA00-16-500DB-UV

### OUTDOOR UV DIRECT BURIAL SPEAKER WIRE

- 16 Gauge
- 500 Ft.
- 152.4 M.



## CA00-16-502DB-UV

### OUTDOOR UV DIRECT BURIAL SPEAKER WIRE

- 16 Gauge
- 500 Ft.
- 152.4 M.



The white Jacket is the hard plastic which allows this cable to be buried and protected.

**OUTDOOR**



The white Jacket is the hard plastic which allows this cable to be buried and protected.

**OUTDOOR**

- N-214-6GB
- N-214-12GB
- N-214-25GB
- N-214-50GB
- N-214-75GB
- N-214-100GB



VIDEO CABLE

- RG-6
- Black
- Gold Tips
- Twist-On Connector Ends

- N-214-6GW
- N-214-12GW
- N-214-25GW
- N-214-50GW
- N-214-75GW
- N-214-100GW



VIDEO CABLE

- RG-6
- White
- Gold Tips
- Twist-On Connector Ends

- N-223-3GB
- N-223-6GB



VIDEO CABLE

- RG-6
- Black
- Gold Tips
- Push-On Connector Ends

- N-223-6GW
- N-223-25GW



VIDEO CABLE

- RG-6
- White
- Gold Tips
- Push-On Connector Ends

- RCA-500



AUDIO CABLE

- Mono
- 500 Ft.



- RCA-503



VIDEO & AUDIO CABLE

- Stereo
- 500 Ft.



VIDEO CABLES

**N-214-6B**

**N-214-12B**

F TO F CONNECTORS

- Available in 3', 6', 12' & in Black or White



**N-215**

RCA TO RCA CONNECTORS

- 6'
- Black



**N-215G**

RCA TO RCA CONNECTORS

- 6'
- Black
- Gold Tips



**N-217**

BNC TO BNC CONNECTORS

- 6'
- Black



**N-223-3B**

**N-223-6B**

F TO F QUICK CONNECTORS

- Available in 3' or 6' in White & 3', 6' or 12' in Black



**V-075-6**

3 RCA TO 3 RCA CABLE

- 6' Nickel-Plated RCA Connectors
- Audio/Video
- Stereo
- Fully Molded
- Low-Loss
- Shielded



**V-175**

6' NICKEL PLATED RCA CONNECTORS

- Audio/Video
- Stereo
- Fully Molded
- Low-Loss
- Shielded
- Color Coded



**V-35-275F**

AUDIO CABLE

- Cable 6"



VIDEO & AUDIO

CABLES

**N64-100**

AUDIO/VIDEO CABLE

- For Nintendo 64



**PSX-300**

AUDIO/VIDEO CABLE

- For Playstation



**V-275-3 (3")**

**V-275-6 (6")**

**V-275-12 (12")**

**V-275-25 (25")**

**V-275-50 (50")**

AUDIO/VIDEO STEREO

- RG-6 Video Cable
- Gold-Plated RCA Connectors
- Fully Molded
- Low-Loss
- Shielded
- Color Coded



**HD-315-6 (6")**

**HD-315-12 (12")**

CABLE

- Component Cable
- VGA to RGB Component Cable



**OFC-3 (3")**

**OFC-6 (6")**

**OFC-12 (12")**

**OFC-25 (25")**

CABLE

- Optical Fiber Cable



**N-203-6**

**N-203-12**

**N-203-25**

**N-203-50**

CABLE

- Stereo
- 2 RCA Plugs to 2 RCA Plugs Color Coded
- With Gold Connectors



**N-207J**

PLUG TO RCA JACKS

- 1/4" Mono Plug to 2 RCA Jacks



**N-207P**

**PLUG TO RCA JACKS**

- 1/4" Mono Plug to 2 RCA Jacks



**N-208**

**PLUG TO RCA JACKS**

- 1/4" Mono Plug to 2 RCA Jacks



**N-209**

**PLUG TO RCA JACKS**

- 1/4" to 1 RCA Plug & 1 RCA Jack



**N-211J (Stereo)**

**N-212J (Mono)**

**JACKS**

- 3.5mm to 2 RCA Jacks



**N-213 (6")**

**RCA TO RCA CONNECTORS**

- 3.5mm to RCA Plugs



**N-216-3 (3' Feet)**

**N-216-6 (6' Feet)**

**N-216G (6' Feet)**

**N-216-3G (3' Feet)**

**CABLE PLUG**

- Stereo
- 3.5mm Plug to 3.5mm Plug
- 6'



**N-221 (6" Inches)**

**N-221-6 (6' Feet)**

**JACKS**

- Stereo
- 3.5mm Plug to 2 3.5mm Jacks



**N-311P-5**

**PLUG TO RCA JACKS**

- 3.5mm Stereo/ Video Plug to 3 RCA Cable



**N-199S (Stereo)**

**HEADPHONE EXTENSION**

- 3.5mm
- 20'



**N-D103TV**

**10 PIN DIN PLUG TO RCA 4**

- Connection Type Features: 3-Male to 10-Pin RCA Composite Audio-Video Cable
- Perfect Audio Video Cable that Eliminates Unwanted Noise/Feedback for Pure, Clear Audio-Video; Minimal Signal Loss for Reliably Consistent Video
- Cable Length: 5 Feet (1.3 Meters)



VIDEO & AUDIO

CABLES

**N-211P** (6" Inches)  
**N-211P-6** (6' Feet)  
**N-211P-6G** (6' Feet gold)  
**N-211P-12G** (12' Feet Gold)

PLUG TO RCA JACKS

- 3.5mm to 2 RCA Plugs



**N-218**  
 RCA TO RCA JACKS

- RCA Plug to 2 RCA Plugs



**N-234-6** (6")  
**N-234-12** (12")

MONO PLUG

- Black
- 3.5mm to 1/4"



**N-219** (6")  
**N-219G** (6" Gold)

RCA PLUG TO RCA JACKS

- RCA Plug to 2 RCA Jacks



**N-350S-6**  
 PLUG

- 3.5 ST Plug to 3.5 ST Jack
- 6'



**N-350S-6G**  
 PLUG

- 3.5 ST Plug to 3.5 ST Jack
- Gold
- 6'



**N-350S-12**  
 PLUG

- 3.5 ST Plug to 3.5 ST Jack
- 12'



## PA-6-2600UBT

### 6 ZONE PA AMPLIFIER WITH USB AND BT

- With Built-In USB / Bluetooth / Tuner/ TF Card
- With 3 MIC Inputs, 2 AUX Inputs and 1 Line Output
- 100V, 70V and 4-16 Ohms Transformer Isolated Speaker Outputs
- Independent Gain Control for Each Zone
- Separate BASS and TREBLE Control
- Power Requirement: 110-220V AC, 50/60 Hz
- Power and Level Indicators
- Gain Control and Power Switch





TELEPHONE  
ACCESSORIES



***2022 CATALOG***







**KR-205-15**

**KR-205-25**

**MODULAR SINGLE JACK**

- Extension Cord
- Ivory Color
- Available in 15 Ft and 25 Ft.



**KR-206**

**MODULAR DOUBLE JACK**

- 25 Ft. Extension Cord
- Ivory Color



**KR-209-7-BLK**

**KR-209-7-IVR**

**KR-209-15-BLK**

**KR-209-15-IVR**

**KR-209-15-WHT**

**KR-209-25-BLK**

**KR-209-25-IVR**

**KR-209-25-WHT**

**MODULAR HANDSET**

- Coiled Cord Made of Elastic Tinsel Material
- Available in 7', 15' & 25' in Black, Ivory & White



**KR-220**

**FLAT TELEPHONE CABLE**

- 4 Conductors, Flat Type
- Color Coded
- 20 Gauge
- 1000' Spool



**KR-425-7**

**KR-425-15**

**KR-425-25**

**KR-425-25-BLK**

**KR-425-25-WHT**

**KR-425-50**

**KR-425-100**

**MODULAR STRAIGHT LINE CORD**

- Four Pin Plug to Four Pin Plug
- Available in 9", 7', 15', 50' & 100'



**KR-127**

**MODULAR JACK ASSEMBLY**

- 5 Outlet
- Plastic Casing
- White Color





**KR-468**

**MODULAR SURFACE JACK**

- 4 Pin Modular Surface Jack with Screws
- Stick-On Pad, Dual Jack
- Ivory Color



**KR-468D**

**DOUBLE MODULAR SURFACE JACK**

- 4 Pin Modular Surface Jack with Screws
- Stick-on Pad, Dual Jack
- Ivory Color



**KR-468M**

**MINI MODULAR SURFACE JACK**

- Mini Modular Surface Jack
- Ivory Color



**KR-175**

**TELEPHONES/VIDEO OUTPUT JACK**

- Ivory Color
- Plastic Casing



**KR-216 (IVORY)  
KR-216W**

**TELEPHONE SINGLE WALL JACK PLATE**

- Flush Mount
- Available in Ivory and White Color



**KR-217**

**DUAL WALL JACK PLATE**

- Flush Mount
- Available in Ivory & White



**KR-783**

**FLASHER/RINGER**

- Plastic Casing
- Ivory Color



**GTS-524**

**INTERCOM SYSTEM (PAIR)**

- 110V
- Plastic Casing



**KR-200**

**MODULAR IN-LINE COUPLER**

- Plastic Casing
- Ivory Color
- Single Jack



**KR-201**

**TRIPLEX ADAPTER**

- Plastic Casing
- Ivory Color
- 2 Jacks





**KR-202**

**MODULAR DOUBLE ADAPTER**

- Plastic Casing
- Ivory Color
- 2 Jacks



**KR-203**

**MODULAR TRIPLE ADAPTER**

- 2 Line T-Junction
- 3 Jacks
- 1 Plug
- Ivory Color



**KR-204L (4-PIN)**

**KR-208L (2-PIN)**

**MODULAR OUTLET PLUG**

- KR-204L (1000 x Pack)
- KR-208L (100 x Pack)



**KR-128**

**HANDSET UNTANGLER ADAPTER**

- Prevents Tangled Cords
- Does not Affect Sound Quality
- Automatically Rotates to Eliminate Twisted Telephone Cords



**DSL-F200**

**DSL SPLITTER**

The In-Line Adapter Connects between the Wall Jack and Voice Device (e.g. Phone, Fax, Answering Machine, Caller ID) Providing both an Unfiltered DSL Jack for DSL Connection and a Filtered Jack for a Single Line of Voice Device Communications.

Eliminates all Erratic Impedance from Telephone Equipment that Interfere with DSL Communications.



**KR-U100-IVR**

**BRUSH WALL PLATE**

- Color: Ivory
- Brush gate size: 20 x 55 mm



**KR-U100-WHT**

**BRUSH WALL PLATE**

- Color: White
- Brush gate size: 20 x 55 mm



2.75"

4.5"



2.75"

4.5"



*2022 CATALOG*



**N-1000G**

**2-WAY "F" SPLITTER WITH SCREWS**

- Bandwidth: 5-900MHz
- Impedance: 75 Ohms
- CATV Signal
- Gold
- Connects Two TVs from One Antenna



**N-1001G**

**MINI 2-WAY "F" SPLITTER WITH SCREWS**

- Bandwidth: 5-900MHz
- Impedance: 75 Ohms
- CATV Signal
- Gold
- Connect Two TVs from One Antenna



**N-1003G**

**3-WAY "F" SPLITTER WITH SCREW**

- Bandwidth: 5-900MHz
- Impedance: 75 Ohms
- CATV Signal
- Gold



**N-1005G**

**4-WAY "F" SPLITTER WITH SCREWS**

- Bandwidth: 5-900MHz
- Impedance: 75 Ohms
- CATV Signal
- Gold



**F-81G**

**FEMALE SPLICE CONNECTOR FOR COAXIAL CABLE WITH NUT AND WASHER**

- Set of Two
- Gold



**NF-81G**

**FEMALE SPLICE CONNECTOR FOR COAXIAL CABLE**

- Set of Two
- Gold



**GOLD  
SERIES**

**CONNECTORS**

**NF-6G**

**TWIST-ON CONNECTORS FOR  
RG-59 CABLE**

- Set of Two
- Gold



**NF-56G**

**TWIST-ON CONNECTORS FOR  
RG-6 CABLE**

- Set of Two
- Gold



**P-101T-G**

**1/4" MONO PLUG WITH TAIL**

- Metal Body
- Gold



**P-103T-G**

**1/4" STEREO PLUG WITH TAIL**

- Metal Body
- Gold



**P-106S-G**

**3.5MM STEREO PLUG**

- Set of Two
- Gold



**P-110G**

**3.5MM STEREO PLUG  
TO 1/4" JACK**

- Set of Two
- Gold



**P-119G**

**MOLDED ADAPTER**

- RCA Jack to RCA Jack
- Set of Two
- Gold



**P-119BL**

**MOLDED ADAPTER**

- RCA Jack to RCA Jack
- Set of Two
- Gold



**P-120G**

**RCA MALE TO RCA MALE**

- Set of Two
- Gold



**P-127G**

**RCA PLUG**

- Set of Two
- Metal Body
- Gold



**P-219G**

**3.5MM STEREO COUPLER**

- Set of Two
- Gold



**P-221G**

**RCA PLUG TO DOUBLE JACK**

- Gold Connectors



**P-311SG**

**3.5MM TO 1/4" STEREO  
GOLD PLUG**

- Sold by Pairs





## AUDIO / VIDEO CABLE HIGH FREQUENCY SPLITTERS

- V-275-3 (3')
- V-275-6 (6')
- V-275-12 (12')
- V-275-25 (25')
- V-275-50 (50')

### AUDIO/VIDEO STEREO CABLES



- Fully Molded
- Low-Loss Signal
- Shielded Color Coded Wires
- Gold-Plated RCA Connectors

## BL-KOD-1002

### DIGITAL 2-WAY SPLITTER

- 5~2,300MHz
- Power Pass to All Ports
- Splits One Digital Coaxial Cable Signal into Two



## OUTDOOR USE



**N-203-3G**  
**N-203-6G**  
**N-203-12G**  
**N-203-25G**

**STEREO CABLE**

- 2 RCA to 2 RCA
- Color Coded Wires
- Available in 3', 6', 12', 25'
- Gold Tips



**N-216-3G (3')**  
**3.5MM TO 3.5MM**

- Stereo Audio Cable, Gold Tips



**N-216G (6')**  
**3.5MM TO 3.5MM**

- Stereo Audio Cable, Gold Tips



**N-219G**  
**RCA STEREO PLUG TO 2 RCA STEREO JACKS**

- Gold Tips



**N-350S-6G**  
**3.5MM STEREO PLUG TO 3.5MM STEREO JACK**

- 6'
- Gold Tips



**GOLD  
SERIES**

**CABLES**

**N-211P-6G (6 IN.)**

**N-211P-12G (12 IN.)**

**STEREO PLUG**

- 3.5mm Stereo Plug to 2 RCA Plugs
- Gold Tips



**N-215G**

**RCA TO RCA CONNECTORS**

- 6'
- Gold Tips



**N-213G**

**3.5MM JACK TO 2 RCA PLUGS**

- Gold Tips



**N-214-6GB**  
**N-214-25GB**  
**N-214-50GB**  
**N-214-75GB**  
**N-214-100GB**



**VIDEO CABLE**

- RG-6 Coaxial Cable
- Black
- Gold Tips
- Screw-On Connectors



**N-214-6GW**  
**N-214-25GW**  
**N-214-50GW**  
**N-214-75GW**  
**N-214-100GW**



**VIDEO CABLE**

- RG-6 Coaxial Cable
- White
- Gold Tips
- Screw-On Connectors



**N-223-3GB**  
**N-223-6GB**

**VIDEO CABLE**

- RG-6 Coaxial Cable
- Black
- Gold Tips
- Push-On Connectors



**N-223-6GW**  
**N-223-25GW**

**VIDEO CABLE**

- RG-6 Coaxial Cable
- White
- Gold Tips
- Push-On Connectors



# iStuff

*2022 CATALOG*



### IPOWER-SAM-FC

**FAST CHARGING USB  
WALL CHARGER**



- New OEM Fast Adaptive Wall Charger
- Input 100-240VAC
- Output 5V / 2A; 9V / 1.67A
- Adaptive Fast Charging Powers your Phone at High Speed!!!

### IPLUG

**3.5MM EARBUD SPLITTER**



- Music Always Sounds Better when you have Someone to Share it with. IPLUG makes Sharing Simple, Anytime and Anyplace

### ICABLE-020

**3.5MM PLUG TO 3.5MM PLUG**



- With Small Heads  
1 Meter Long All White

### IW-05

**3.5MM ADAPTOR  
TO RCA CABLE**



- 3.5mm Female Plug to Dual RCA Plugs
- Silver-Plated Plug
- Blister Card Packing

### IWS-SAM-RS

**REVERSIBLE USB 2.0A MALE  
TO MICRO USB CABLE**



- High Speed USB 2.0
- Compatible with Smart Phone
- Charging and Data Transmission
- Nickel-Plated Connectors
- Both Connectors are Reversible

### BL-IP-35-USB6

**3.5MM AUDIO/VIDEO  
STEREO PLUG TO USB CABLE**



- 6 Ft Cable.
- White Color

### N-3514-6

**3.5MM PLUG TO 1/4"  
PLUG CABLE**



- 6' Cable.
- Black Color

### IW-35D35-6

**3.5MM EARPHONE SPLITTER**



- 6' Cable.
- White Color

# iStuff

## IPOD ACCESSORIES

### IWS-02MIB

#### MINI USB TO USB CABLE

- High Speed USB 2.0
- Compatible with Mobile Phone, MP3, MP4 & Camera
- Charging and Data Transmission
- 3.3' / 1m



### IWS-02MOB

#### MICRO USB TO USB CABLE

- High Speed USB 2.0
- Compatible with Android Smart Phones
- Charging and Data Transmission
- 3.3' / 1m



### IWS-20SMT

#### CHARGING CABLE FOR SAMSUNG TABLET

- High Speed USB 2.0
- Compatible with Samsung Tablet PC
- Charging and Data Transmission
- 3.3' / 1m



### IWS-03UTC

#### USB 3.0 A MALE TO USB TYPE-C™ MALE CABLE

- (Compatible with MacBook Air and other USB Type-C™ Compatible Devices)
- Connects USB Type-C™ Device to a USB-A Port on a USB-A Device, such as USB Charger or Computer
  - Power Output up to 3A
  - Data Transfer up to 5Gbps

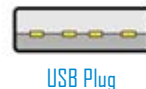
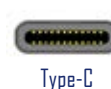

### BL-HD-MIMAD

#### MHL TO HDMI ADAPTOR

- Connect your MHL-Enabled Phone to your High Definition TV or Computer Monitor
- Requires Standard HDMI Cable and Micro USB Charging Cable
- Simply Add Plug between MHL Adapter and your Device as Shown
- 5-Pin to 11-Pin Adapter Plug Allows you to use your MHL Smart Adapter with the Latest Galaxy and MHL Compatible Devices



### ICL-THREEU-B

#### TRIPLE USB CAR CIGARETTE LIGHTER ADAPTER

- Output: 12~24V
- Charges iPod, iPhone, iPad other Smartphones, mp3 and mp4 Players, and Cameras Via USB Port
- Smart Fuse for Surge Protection



3 Ports

### ICL-200U-SLV

#### DUAL USB CAR CIGARETTE LIGHTER ADAPTER

- Input: 12~24V
- Output: 5V-2.4A
- Can Quickly Recharge any Smartphone, Tablet, or other USB Powered Devices Directly from your Car's DC Power Socket
- Built-In Over-Current Protection
- Automatic Short Circuit Protection Function
- The IC Includes an Over Temperature Protection Inside. The Maximum Working Voltage could Reach 40V and it could Prevent the High Voltage of Cigarette Lighter from Damaging the Production
- The LED will Change to Blue when the Car Charger is put in the Cigarette Lighter
- Material: ABS Housing+Aluminum Housing



2 Ports

### ICL-300U-SLV

#### TRIPLE USB CAR CIGARETTE LIGHTER ADAPTER

- Input: 12~24V
- Output: 5V-3.4A
- Can Quickly Recharge any Smartphone, Tablet, or other USB Powered Devices Directly from your Car's DC Power Socket
- Built-In Over-Current Protection
- Automatic Short Circuit Protection Function
- The IC Includes an Over Temperature Protection Inside. The Maximum Working Voltage could Reach 40V and it could Prevent the High Voltage of Cigarette Lighter from Damaging the Production
- The LED will Change to Blue when the Car Charger is put in the Cigarette Lighter
- Material: ABS Housing+Aluminum Housing



3 Ports

# iStuff

## IPOD ACCESSORIES

**ICC-3535-BLK6**

**ICC-3535-RED6**

**ICC-3535-WHT6**

### CABLE AUDIO/VIDEO/TELEPHONE

- The Soft Material and Configuration Ensure that Cable is Easy to Pack & Use
- The Coiled Audio Cable is more Suitable for your Multimedia Devices to Connect Freely and Easily
- It can Help you to Share your Favorite Music with other People by Connecting your DVD, CD, Mp3 and Mp4 Players or other Multimedia Devices to Multimedia Speakers



**IHD-300-BLUG**

**IHD-300-GRNG**

**IHD-300-GRY6**

### HDMI ETHERNET CHANNEL

- Transports Audio and Video Signals in One Cable
- 3D: Defines Input/Output Protocols for Major 3D Video Formats, Paving the Way for True 3D Gaming and 3D Home Theater Applications
- High Speed Bandwidth up to 340MHz (10.2Gbps)
- Audio Return Channel 0
- Supports 8-Channel Digital Audio and New Lossless Audio Format: Dolby TrueHD and DTS-HD Master Audio
- 4K: Enables Video Resolutions up to 4 Times of 1080p, 3840 2160@24Hz/25Hz/30Hz, 4060x2160@24Hz
- Deep Color from 24-bit up to 30-bit, 36-bit, 48-bit (sYCC601 Color, Adobe RGB Color or Adobe YCC601) Color Depths



**IFUA-3MU-GRN**

**IFUA-3MU-GRY**

**IFUA-3MU-ORG**

### USB TO MICRO USB CABLE COMPATIBLE WITH



Type-C

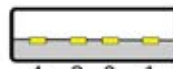

USB Plug

**IFUA-3MU-GRN**

- Flat Design with very Flexible TPE Jacket
- 100% Gold-Plated USB Port
- Color: Green

**IFUA-3MU-GRY**

- Flat Design with very Flexible TPE jacket
- 100% Gold-Plated USB Port
- Color: Gray

**IFUA-3MU-ORG**

- Flat Design with very Flexible TPE jacket
- 100% Gold-Plated USB Port
- Color: Orange





### IRC-3535-GLD6 (Gold Color)

#### 3.5MM STEREO CABLE

- The Soft Material and Configuration Ensure the Cable is Easy to Pack & Use
- This Pocket Cable is more Suitable for your Multimedia Devices to Connect Freely and Easily
- It can Help you to Share your Favorite Music with other Peoples by Connecting your DVD, CD, Mp3 and Mp4 Players or other Multimedia Devices to Multimedia Speakers
- 6' / 1.8m



### IRC-3535-GRY6 (Gray Color)

#### 3.5MM STEREO CABLE

- The Soft Material and Configuration Ensure the Cable is Easy to Pack & Use
- This Pocket Cable is more Suitable for your Multimedia Devices to Connect Freely and Easily
- It can Help you to Share your Favorite Music with other Peoples by Connecting your DVD, CD, Mp3 and Mp4 Players or other Multimedia Devices to Multimedia Speakers
- 6' / 1.8m



### IRC-3535-ORG6 (Orange Color)

#### 3.5MM STEREO CABLE

- The Soft Material and Configuration Ensure the Cable is Easy to Pack & Use
- This Pocket Cable is more Suitable for your Multimedia Devices to Connect Freely and Easily
- It can Help you to Share your Favorite Music with other Peoples by Connecting your DVD, CD, Mp3 and Mp4 Players or other Multimedia Devices to Multimedia Speakers
- 6' / 1.8m



### IRC-3535-SLV6 (Silver Color)

#### 3.5MM STEREO CABLE

- The Soft Material and Configuration Ensure the Cable is Easy to Pack & Use
- This Pocket Cable is more Suitable for your Multimedia Devices to Connect Freely and Easily
- It can Help you to Share your Favorite Music with other Peoples by Connecting your DVD, CD, Mp3 and Mp4 Players or other Multimedia Devices to Multimedia Speakers
- 6' / 1.8m



### IRC-3535-RED6 (Red Color)

#### 3.5MM STEREO CABLE

- The Soft Material and Configuration Ensure the Cable is Easy to Pack & Use
- This Pocket Cable is more Suitable for your Multimedia Devices to Connect Freely and Easily
- It can Help you to Share your Favorite Music with other Peoples by Connecting your DVD, CD, Mp3 and Mp4 Players or other Multimedia Devices to Multimedia Speakers
- 6' / 1.8m



### IPOWER-01-USB

#### USB CHARGER POWER ADAPTER

- Input: 100~240V, 50/60Hz
- Output: 5V / 2.1A
- Charges Most Multimedia Devices such as Tablets, Smartphones, MP3/MP4 Players and Cameras VIA USB Port



**5V / 2.1A**



# iStuff

## MOBILE POWER OUTLET

### IPOWER-02-USB

#### USB CHARGER POWER ADAPTER

- Input: 100~240V, 50/60Hz
- Output: 5V / 2.1A
- Charges Most Multimedia Devices such as Tablets, Smartphones, MP3/MP4 Players and Cameras VIA USB Port



2 Ports - 5V / 2.1A



### IPOWER-EUR2-USB

#### DUAL USB TRAVEL CHARGER PLUG

- Input: 100~240V, 50/60Hz
- Output: 5V / 2.0A
- Charges most multimedia devices such as tablets, smartphones, MP3 & MP4 players, and cameras via USB port



2 Ports - 5V / 2.0A



### IPOWER-107WRG

#### DUAL USB CAR CHARGER - 2.1A

- Compatible with: iPad®, iPad®2, iPhone® 3G/3GS/4G, Samsung, Huawei & any Devices needing USB Cable for Power
- Plug into Car Cigarette Lighter Jack to become a Powered USB Port
- Compact Design
- Input: DC 12V-24V
- Output: DC 5V 2.1A & 5V 1A



### IS-CMT-AR-6

#### UNIVERSAL DASHBOARD/WINDSHIELD SMARTPHONE MOUNT

- Works on the Windshield or Dashboard of the Car
- Compatible with Devices up to 82mm Width
- Quick Release Device with a Tap of your Finger



Phone is not Included

### NP-5000BT

#### BT STREAMING AUDIO KIT + FM TRANSMITTER + 3.4A CAR CHARGER

- BT Version/Versión de BT: V2.1
- Frequency Range/Rango de Frecuencia: 87.6~107.9MHZ
- Frequency Stability/Estabilidad de la Frecuencia: ±10ppm
- Input/Entrada: 12~24V
- Music Format/Formato de la Música: Mp3, WMA
- Micro SD Card (Max Capacity)/Micro Tarjeta SD (Máxima Capacidad): 32GB
- USB Disk (Max Capacity)/Disco USB (Máxima Capacidad): 32GB



### NP-6000BTR

#### WIRELESS MUSIC STREAM CAR CHARGER

- Suitable for all type of vehicles.
- LED Display.
- Support QC 3.0 quick charge.
- Supports: Huawei FCP; Samsung AFC; QC 3.0; QC 2.0; D+ & D-2.7V DCP; Charging for iPhone max output 2.4A; USB BC 1.2 protocol complied.
- Supports stereo audio FM transmission.
- Supports U-disk play.
- Supports TF card play.
- Supports: WMA; MP3; WAV; APE; FLAC music format.
- Autopower-off memory function.
- Supports: A2DP; AVRCP; HFP; HSP.
- Version: V5.0.
- Supports "hands-free".
- Supports "hands-free" stereo audio DSP technology.
- Supports RGB color change 7 colors and breathing mode.



### NP-700IT2U

#### BLUETOOTH CAR CHARGER

- LED Display
- Dual USB Charging (QC3.0+5V/1A)
- FM Transmitter 87.5-108.0MHZ
- Supports U-Disk
- Supports MP3 Music Formats
- Automatic Power-Off Memory Function
- Car Cigarette Power Supply
- Bluetooth V4.2
- Bluetooth Hands-Free Calling
- Bluetooth Stereo Music Play w/DSP Technology
- Car Accumulator Voltage Detection
- Automatic Bluetooth Reconnection



### NP-900IT2U

#### BLUETOOTH CAR CHARGER

- SNR: >60dB
- Frequency Response: 20Hz-20KHz
- Effective Distance: 0.5-2 M
- FM Frequency: 87.5 - 108MHz
- FM Transmission Distance: 2M
- TF Card Capacity: 1G-32G



### WAC-525IBLK

#### WIRELESS CHARGER WITH ALARM

- ABS material
- Input: 5V/2A, 9V/1.67A
- Wireless Output: 10W/7.5W/5W
- USB Output: 5V/1A (Max)
- Night lamp brightness: 3 Levels
- Time display mode: LED
- Time system: 12H/24H



# iStuff

## IPOD ACCESSORIES

### NP-8635USR

#### CAR MP3 FM TRANSMITTER

- With LCD Screen, Display the No.
- 206 Channels Optional: 87.5~108MHz
- Supports 4 Loop Modes
- Memorizes the Last Played Frequency, Song & Volume
- Supports USB Disk & SD/MMC Card
- Supports 12~24 Voltage
- Switch the Folder by Remote Directly



### NP-9025UBTEL

#### WIRELESS FM TRANSMITTER & CAR CHARGER

- Wirelessly Transmit Phone Call & Music from Wireless Mobile Phone to the Car FM Stereo System
- Power from the Cigarette Socket in the Car (DC 12V/24V)
- USB Output to Charge External Devices (DC 5V/1A)
- With LCD Screen to Display Numbers.
- 206 Channels optional from 87.5-108.0MHz.
- Detects the Voltage of Car Battery when Power On
- Wireless Version: V2.1, Support A2DP, AVRCP, HFP
- Wireless Version: JL 2.1
- Wireless Protocol: HFP, A2DP, AVRCP
- Screen: LCD Display



### NP-9950UB TEL

#### WIRELESS CAR FM TRANSMITTER WITH 2.1A DUAL USB CAR CHARGER

- Wirelessly Transmit Phone Call from Wireless Mobile Phone to the Car FM Stereo System
- Switch to Hands-Free Mode Automatically from Music Playing Status when Receiving Calls
- Supports Music Play Back from USB and SB Card
- Built-In Microphone
- 3.5mm Aux Jack to Support Play Back from External Audition Devices
- Dual USB Output to Charge for Mobile Phones and other Devices
- Strong and Elegant Design with LCD Frequency Display
- With Remote Control
- With Voice Prompts



### Q-U-BSIG-30

#### USB BT DONGLE

- For Mobile Phone, Laptop, PDA, Headphone, etc.
- Once Successfully Paired, your Audio from your Source Unit will be Streamed Via the Q-U-BSIG-30
- V2.1
- 8-10M Distance



### Q-U-BSIG-35C

#### WIRELESS MUSIC RECEIVER

- Support A2DP V1.2
- Powered by 5V DC
- Transmission Rate: 3 (Mbps)
- Transmission Distance: >10 M
- Power Supply Mode: USB-POWER



Plug this wireless music receiver into any speaker via USB port and connect with any smartphone device for wireless music streaming.



### Q-SIG10-BK

#### BLUETOOTH RECEIVER

- Version: 2.1
- Rechargeable Battery: 350mAh
- Power Consumption: 5V, 1A
- Charging Time: 2Hrs
- Battery Life: 5~7Hrs
- Ports: 3.5mm Audio Output, Mini USB for Charging
- Range: 10M
- LED Indicators for Charge and Connection
- Package Content: 1 x Bluetooth Receiver, 1 x 3.5mm Cable, 1 x Mini USB Cable
- Weight: 0.05LB (21g)
- Dimensions: 2.4" x 1.4" x 0.6" (6x3.6x1.5cm)



Converts any Wired Audio Input to a Wireless Input

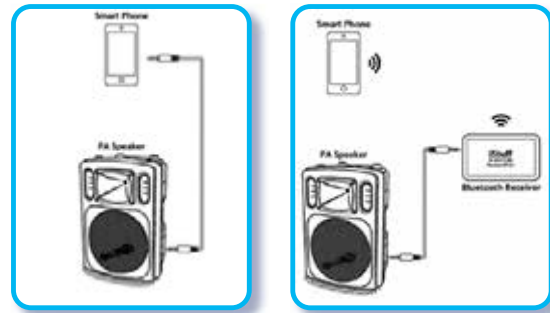

### Q-SERE10-BLK

#### WIRELESS AUDIO RECEIVER/TRANSMITTER

- Supported Protocol: A2DP, AVRCP
- Wireless Distance: > 10M
- Built-In Battery: 600MA
- Playing Time: > 8H
- Charging Time: About 2H
- Charging Input Voltage: DC 5V
- Input/Output Connecting Mode: 3.5MM Stereo Audio Port
- Compatibility: Compatible with Phones and PAD of Android/iOS System, and all Wireless Audio Devices



10M Range

#### Your audio transmission Master

Used for all audio interface device, like TV, PC, CD Player, iPad, iPhone etc. Real-time low latency and high-quality audio transmission.

#### Receive Mode

Easily connected via wireless, transmit sound to devices with audio interface.



#### Transmit Mode

Transmit the audio of CD Player, TV, PC, online games and other devices to the wireless headset, making you freely enjoying the music.

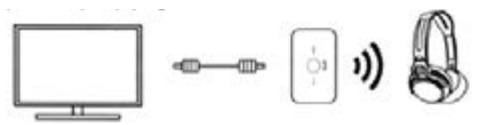

### Q-SIG4U

#### USB BT DONGLE

- BT V4.0
- BT Low Energy Wireless USB Adapter
- Dual-Mode BT Transmission
- Supports BT Voice and Data
- Supports Multi-Language
- Wireless Local Area Network Share Interface
- Supports Network, Dial-Up, Fax, LAN Access
- Sensible Rate: -86dB
- Transmission Distance: 65.6' (20m)
- Interface: USB 2.0
- BT Driver: CSR Harmony Wireless Software Stack
- Available OS: Windows XP/Vista/7/8



### E2N

#### USB 2.0 CONNECTOR

- 3.5mm Wire Control Cable Allows Audio to be Played through your PC, Notebook, DVD Player and Cell Phones
- Requires no External Batteries



COMPUTER  
ACCESSORIES

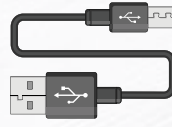

2022 CATALOG



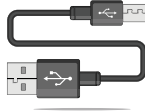

**DVU-DC55-21**

**POWER DEVICES FROM A  
USB PORT**

- For Small Electronics and Devices which
- Provides 5V DC from USB
- Type A Male USB Plug to 5.5mm (Outer), 2.1mm (Inner) Male Coaxial/ Barrel Plug with Positive Center Pin



**IBM-205-6**

**IBM-205-12**

**IBM-205-25G**

**USB A MALE TO USB  
A FEMALE CABLE**

- 6' / 12' / 25'
- Extends USB Connection to Computer, for use with Printers, Cameras, Mouse, Keyboards and other USB Computer Peripheral



**IBM-A-B-6 (6 ft)**

**IBM-A-B-12 (12 ft)**

**USB A MALE TO  
B MALE CABLE**

- Commonly used for Printers, Scanners and other Devices



**IBM-425-3 (3')**

**IBM-425-6 (6')**

**IBM-425-10 (10')**

**IBM-425-15 (15')**

**IBM-425-25 (25')**

**IBM-425-50 (50')**

**IBM-425-75 (75')**

**IBM-425-100 (100')**

**CATS PATCH CORD**

- RJ45 plugs
- Booted
- Stranded
- Available in Ivory
- UL Approved



COMPUTER  
ACCESSORIES

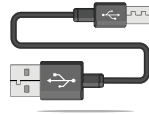

ACCESSORIES

IBM-USBF-MIN5

USB FEMALE TO MINI 5PIN

- Allows Easy Conversion of Cables Commonly used for Digital Cameras



BL-IBM-AFAF200

USB A TYPE FEMALE COUPLER

- Platinum-Plated Connectors



IBM-RJ45

RJ45 PLUGS

- Wire Insert
- 8p8c
- 56u Gold
- For use with Solid and Stranded Cables



VGA-M-RJ45F

VGA TO RJ45

- Adapter



VGA-VASPL-1004

VGA SPLITTER 1X4 WITH AUDIO

- Easy to Use: Install in Seconds, no need of Setting
- Connects VGA Source to Four Displays at the Time
- Connects Stereo Audio Source to Four Audio Receivers at the time
- Supports Highest Video Resolution up to 1920 x 1200 and 1080p
- Supports Highest Video Amplifier Bandwidth to 500MHz



IBM-A-BMINI-10

USB A TO MINI B USB CABLE

- Commonly used for Digital Cameras, Cell Phones, MP3 Players, PDA Devices
- 10'



BL-IBM-MOS300

USB OPTICAL WHEEL MOUSE

- High-Precision Mouse
- Plug and Play no Driver Required
- Ergonomic Design



BL-IBM-104USB

USB 4-PORT HUB

- Includes Hub and USB Cable
- Suitable for Notebooks





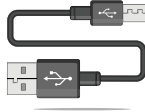

**BL-IBM-USB35-HM**

**INTEGRATED 2CH USB AUDIO CONTROLLER**

- Supports 3D Sounds (AC-3) and Virtual 5.1 Surround Soundtrack
- The Best Entertainment for Listening to DVD, CD's and General Online Content
- Plug and Play, no Software Required
- Eliminate the Need for a Traditional Sound Card with this USB to Audio Adapter. Real USB Plug & Play to Upgrade any On-Board Sound Card to 5.1 Digital
- Surround Sound without any Hardware Installation
- Connect a Speaker or Headphone Directly



**BL-IBM-ID4USBC**

**FOUR PORT USB 2.0 HI-SPEED HUB**

- 1 Upstream and 4 Downstream USB Port Included, Fully Compliant with USB Specification Version 2.0 Hot Plug & Play USB Device
- Half-Transparent Design with Blue LED Power Indicator
- Interface: USB 2.0, Compatible with USB 1.1
- Data Transfer Rate: 1.5Mbps / 12Mbps / up to 480Mbps
- Bus-Power Limit Current Protection: 500mA



**DLPT-TYC-45**

**UNIVERSAL DEVICE TYPE C CHARGER**

- Input: 110V~240V, 50/60Hz, 1.1A
- Output: 5V/2A, 9V/2A, 12V/2A, 14.5V/2A, 15V/3A, 20V/2.25A
- Widely Compatible with USB-C Enabled Smart Phones, Tablets, Laptops and Computers. Works with Macbook 2016, New Macbook Pro 2016, Dell XPS 13, HP Spectre and more USB-C Laptops



**45 Watts  
Power**

- PROTECTED MANAGEMENT  
**USB Type-C**
- Automatic Voltage Selection
- Faster Charging

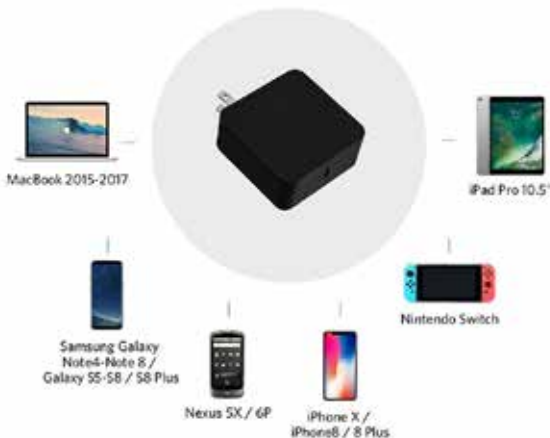

COMPUTER  
ACCESSORIES

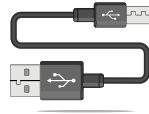

KEYBOARDS

BL-IBM-KM700

WIRELESS KEYBOARD + MOUSE COMBO

MOUSE FEATURES:

- High Precision Optical Sensor (200PI)
- Precision Scroll Wheel
- Nano Receiver Receptacle
- Auto Standby Mode
- On/Off Switch
- Requires (2) AAA Batteries, Not Included

KEYBOARD FEATURES:

- Unique Slim Design, Stylish Configuration, Comfortable Feeling
- Compatible with all Operating Systems
- Requires (1) AA Battery, Not Included

ADVANCED WIRELESS:

- Advanced 2.4 GHz RF Wireless Technology, Provides up to a 10 Meter Multi-Directional Range and Practicality Interface Free Use

Wireless  
KEYBOARD and Mouse



12M, 360°  
Transmission

BL-IBM-KB370

SLIM DESIGN USB KEYBOARD

- Comfortable to Use
- High-Quality Membrane Key Switch
- Key Stroke Life Time: 10,000,000 Cycles
- USB Interface
- Compatible with Windows Vista 7 and Windows 8
- Slim Design



SLIM KEYBOARD

BL-IBM-WKB-400

WIRED WASHABLE KEYBOARD

- Key: 103K, Port: USB
- Conductive Silver Paste
- Laser Etching Font
- Switch Life More than 5,000,000 Times
- Can be Washed Easily, Submersible up to Depths of 1' / 30cm
- Drain Hole of Backside can Make Keyboard Dry Faster



WASHABLE



KEYBOARD

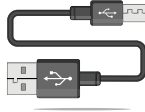

**CD-116**

**LASER LENS CLEANER**

- For Conventional CD Players
- Load the Cleaner into the Carrier on the CD Players with the Side Printed up
- Press "Play" to Run the Cleaner
- Operate as Voice Guide Instructs
- Restore the Cleaner in its Case after use



**CD-128**

**LASER LENS CLEANER**

- For Conventional CD Players
- Load the Cleaner into the Carrier on the CD Players with the Side Printed up
- Press "Play" to Run the Cleaner
- Operate as Voice Guide Instructs
- Restore the Cleaner in its Case after Use



**CSC-200CL**

**LCD SCREEN CLEANING KIT**

- Powerful Cleaning Solution Removes Dust, Dirt and Oily Fingerprints
- Includes a High-Tech Reusable Microfiber Cloth that Cleans Screens without Scratching
- Cleans TVs, Camcorders, Camera Lenses, HD Monitors and other Video Displays



**IBM-200**

**RJ-45 ADAPTER**

- Coupler



**IBM-468**

**CAT5 SINGLE SURFACE MOUNT BOX**

- Loaded
- 110IDC
- Non-Shielded
- Pre-Mounted on PC Board



**AC-400**

**6' COMPUTER AC POWER CORD**

- AWG 18
- 3 Conductor
- Black Jacket



**IBM-RJ-CAT6**

**RJ-45 ADAPTER**

- Plug for CAT6



**PINS#8**

**PINS#14**

**PINS#16**

**PINS#20**

**PINS#24**

**PINS#28**

**I.C. SOCKETS**



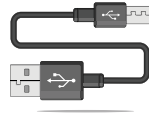

**CAT5E-2-UTP4G**

**INDOOR UTP CAT5E  
NETWORK CABLE**

- 0.51±0.01MM, 24awg
- 4 solid Twisted Pairs
- CCA
- Cat5e UTP 24 AWG
- 0.51mm CCA
- Grey PVC for indoor use
- 4 pairs twisted
- Length: 1000'



**UPC: 784644622919**  
**GIFT BOX SIZE:**  
**8.5" x 14" x 14"**

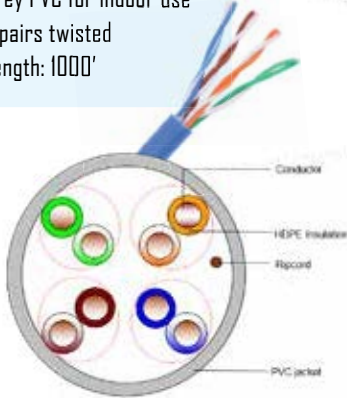

**CAT6-2-UTP4G**

**INDOOR UTP CAT6  
NETWORK CABLE**

- 0.57±0.01MM, 23awg
- 4 solid Twisted Pairs
- CCA
- Cat6 UTP 23 AWG
- 0.57mm CCA
- Grey PVC for indoor use
- 4 pairs twisted
- Length: 1000'



**UPC: 784644622926**  
**GIFT BOX SIZE:**  
**8.5" x 14" x 14"**

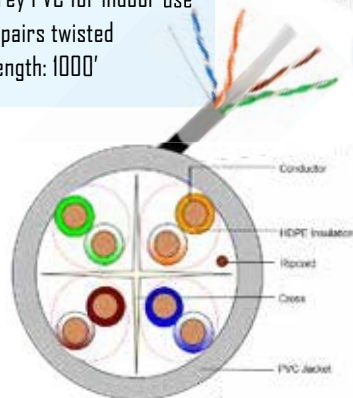

**CAT5E-OD2-UTP4**

**HIGH PERFORMANCE  
OUTDOOR NETWORK CABLE**

- 0.51±0.01MM, 23awg
- 4 solid Twisted Pairs
- CCA
- Cat5e UTP 24AWG
- 0.51mm copper clad aluminum conductors
- Black PE for Outdoor
- 4 Pairs twisted
- Length: 1000'



**UPC: 784644622933**  
**GIFT BOX SIZE: 12.5" x 12.5" x 9.5"**

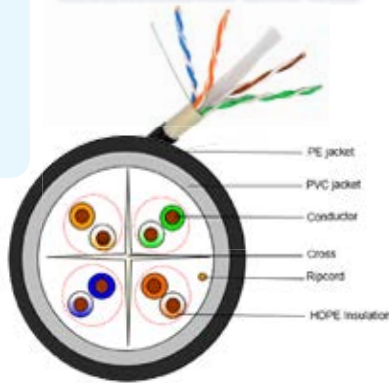

**CAT6-OD2-UTP4**

**HIGH PERFORMANCE  
OUTDOOR NETWORK CABLE**

- 0.57±0.01MM, 23awg
- 4 solid Twisted Pairs
- CCA
- Cat6 UTP 23AWG
- 0.57mm copper clad aluminum conductors
- Black PE for Outdoor
- 4 Pairs twisted
- Length: 1000'



**UPC: 784644622940**  
**GIFT BOX SIZE: 12.5" x 12.5" x 10.25"**

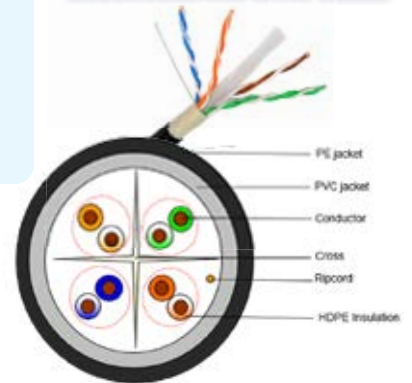

Cold Resistant

Waterproof

UV Resistant

Tensile Force

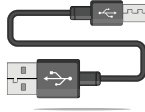

## INDOOR / OUTDOOR LAN CABLE LAPTOP ACCESSORIES

### CAT5EFT-2-UTP4G

#### INDOOR UTP CAT5EFT NETWORK CABLE

- 0.51±0.01MM, 24awg
- 4 solid Twisted Pairs
- CCA
- Cat5e UTP 24 AWG
- 0.51mm CCA
- Grey PVC for indoor use
- 4 pairs twisted
- Length: 1000'
- Fluke test passed



UPC: 784644622957  
GIFT BOX SIZE:  
8.5" x 14" x 14"

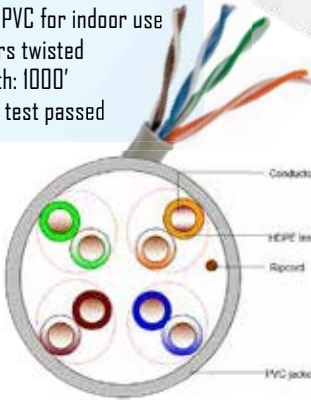

### CAT6FT-2-UTP4G

#### INDOOR UTP CAT6FT NETWORK CABLE

- 0.57±0.01MM, 23awg
- 4 solid Twisted Pairs
- CCA
- Cat6 UTP 23 AWG
- 0.57mm CCA
- Grey PVC for indoor use
- 4 pairs twisted
- Length: 1000'
- Fluke test passed



UPC: 784644622964  
GIFT BOX SIZE:  
8.5" x 14" x 14"

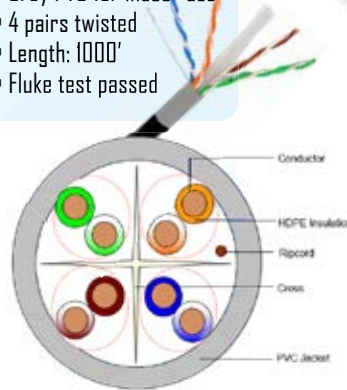

### IBM-FAN250

#### USB POWERED COOLING FAN

- Lighter and thinner design
- Compatible with 15" and below laptops
- Exclusive create the surface with wire drawing craft
- Ergonomic double angle adjustment

#### SPECIFICATIONS:

- Voltage: 5V DC
- Current: 0.35 ± 10% A
- Power: 1.75W
- Rotational speed: 1000 ± 10% RPM
- Air flow: 74.35 CFM
- Fan size: 5.5" x 5.5" x 0.6" (140 x 140 x 15 mm)
- Product dimensions: 12.6" x 9.6" x 0.9" (320 x 245 x 24 mm)
- Weight: 0.68 Lbs (308 gr)



### IBM-FAN-300X

#### NOTEBOOK COOLING PAD

- Silent 120mm Fan with Great Cooling Performance
- Blue LED Shines through the Center Mesh
- Large Metal Mesh for Superior Airflow
- Two Height Settings for the Ideal Viewing and Typing Angle
- USB Port x 2
- Overall Dimensions: 345 x 275 x 54mm
- Fan Dimensions: Ø120mm
- Fan Speed: 1500 rpm ±10%
- Power: DC 5V



15"  
Support Up To 15" Laptops

**COMPUTER  
ACCESSORIES**

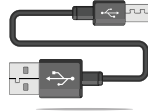

**LAPTOP ACCESSORIES**

**DLPT-451**

**AUTOMATIC UNIVERSAL TABLET AC ADAPTER**

- Input: AC 100~240V, 50/60Hz
- Output: 19, 19.5, 20V, 45W Max
- Compatible with Acer, Asus, Benq, Dell, Gateway, Hp, Lenovo, Samsung, Sony, Toshiba

Type /Tipo	Output /Salida	Connector Size /Tamaño del Conector	Laptop Brand /Marca del Ordenador Portátil
H1	19V/Max45W	5.5x3.0mm	For Samsung 19V, 2.1A
H2	19V/Max45W	4.0x1.35mm	For Asus 19V, 1.75A~2.37A
H3	19V/Max45W	5.5x2.5mm	For Toshiba/Benq/Gateway 19V, 1.58A/19V, 2.1A/19V, 2.37A
H5D	19.5V/Max45W	4.5x3.0mm	For Dell 19.5V 2.31A
H6	19.5V/Max45W	4.5x3.0mm	For Hp 19.5V 2.31A
H7	19V/Max45W	3.0x1.0mm	For Samsung 19V2.1A /For Asus 19V2.37A
H8	19V/Max45W	2.5x0.7mm	For Asus 19V, 1.58~2.1A
H10	19V/Max45W	5.5x1.7mm	For Acer 19V, 1.58~2.15A
H11	19.5V/Max45W	6.5x4.4mm	For Sony 19.5V 2A
H12	20V/Max45W	USB Type	For Lenovo 20V 2.25A



**DLPT-902LUSB**

**90W AUTOMATIC UNIVERSAL AC ADAPTER FOR LAPTOP**

- USB Port Charges for Smart Phone, MP3, MP4, iPad, iPhone, Tablet PC, PDA and Other Related Devices with Standard USB Output
- Multiple Types of Interchangeable Connectors
- Safe and Reliable, Variable Voltages Range from 9.5V~24V
- Multi Country Ready (100V~240V)
- High Grade ABS Housing
- Fire Retardant Case
- Incorporates EMC and EMI Technology, for Absorbing Current Burst and Controlling the Circuitry



Type	Output	Connector Size	Laptop Brand
15.0V/M1	15.0V/Ma x 90W	6.3 x 3.0mm	Toshiba
16.0V/M2	16.0V/Ma x 90W	5.5 x 2.5mm	IBM, Lenovo
16.0V/M3	16.0V/Ma x 90W	6.5 x 1.4mm	Sony, Fujitsu
18.5V/M4	18.0V/Ma x 90W	4.8 x 1.7mm	Compaq, HP
19.0V/M5	19.0V/Ma x 90W	5.5 x 2.5mm	Acer, Compaq, Delta, HP, Fujitsu, Gateway, Toshiba, Liteon
19.0V/M6	19.0V/Ma x 90W	5.0 x 3.0mm	Samsung
19.0V/M7	19.0V/Ma x 90W	5.5 x 2.1mm	Acer, Compaq, Delta, HP, Fujitsu, Gateway, Toshiba, Liteon
19.5V/M8	19.5V/Ma x 90W	6.5 x 1.4mm	Sony
19.5V/M9	19.5V/Ma x 90W	7.4 x 5.0mm	Dell
20.0V/M10	20.0V/Ma x 90W	3 Pin Connector	Dell
20.0V/M11	20.0V/Ma x 90W	7.9 x 5.4mm	IBM, Lenovo
18.5V/M12	18.5V/Ma x 90W	7.4 x 5.0mm	HP, Compaq



**DLPT-UN50-24V**

**AC ADAPTER**

- Input: 100~240V, 1.8A Max, 50/60Hz
- Output: 12~24V, 2A
- Power: 50W
- DC Cable Length: 3.9' / 1.2 m
- 8 Tips



6x4.4 mm 6.3x3 mm 5.5x2.5mm 5.5x2.1mm 5.5x1.7mm 4.8x1.7mm 4x1.7mm 3.5x1.35mm

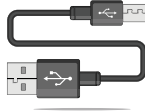

**DLPT-UNI-24**

**AC ADAPTER**

- Input: 100~240V, 1.5A, 50/60Hz
- Output: 24V, 2.5A
- Power: 60W
- DC Connector: 5.5 x 2.1mm
- DC Cable Length: 5.7' / 1.75 m
- 7 Tips



**DLPT-909**

**AUTOMATIC UNIVERSAL AC ADAPTER (90W)**

- Input: AC 100 ~ 240V, 1.8A, 50/60Hz (Max)
- Output: DC 18.5V ~ 20V, 4.74A (Max)
- Power: 90W
- Charges for Laptop, Tablet, Smart Phone, Digital Camera, MP3, & MP4 Player
- Connector Size: 5.7" x 2.7" x 0.6" (144 x 69 x 16mm)



Newly added connector covers latest HP models!

Type /Tipo	Output /Salida	Connector Size /Tamaño del Conector	Laptop Brand /Marca del Ordenador Portátil
H1	19V/Max 90W	5.5 x 3.0mm	Samsung: 19V/3.16A, 19V/4.22A, 19V/4.74A
H3	19V/Max 90W	5.5 x 2.5mm	Toshiba/Lenovo/Asus: 19V/3.42A, 19V/3.95A, 19V/4.74A 20V/3.25A, 20V/4.5A
H5D	19.5V/Max 90W	4.5 x 3.0mm	Dell: 19.5V/3.34A, 19.5V/4.62A
H6H	19.5V/Max 90W	4.5 x 3.0mm	HP: 19.5V/3.33A, 19.5V/4.62A
H10	19V/Max 90W	5.5 x 1.7mm	Acer: 19V/3.42A, 19V/3.95A, 19V/4.74A
H11	19.5V/Max 90W	6.5 x 4.4mm	Sony: 19.5V/3.33A, 19.5V/3.9A, 19.5V/4.7A
H12	20V/Max 90W	USB TYPE	IBM/Lenovo: 20V/3.25A, 20V/4.5A
H13D	19.5V/Max 90W	7.4 x 5.0mm	Dell: 19.5V/3.34A, 19.5V/4.62A
H14H	18.5V/Max 90W	7.4 x 5.0mm	HP: 18.5V/3.5A, 19.5V/3.33A, 19V/4.74A

**CV-HDIDSP**

**HDMI FEMALE TO DISPLAYPORT MALE ADAPTER**

HDMI Adapter to DisplayPort allows for transmission of both audio and video from a supported device to a monitor, HDTV, projector or any other device with DisplayPort.

It supports up to 4K resolution as well as Audio Return Channel (ARC) to manage additional audio devices, such as audio bars, through a single cable.

**SPECIFICATIONS:**

- 4K Resolution support
- Audio Return Channel (ARC) support



**COMPUTER  
ACCESSORIES**

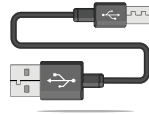

**LAPTOP ACCESSORIES**

**DLPT-1208-USB**

**AUTOMATIC UNIVERSAL CAR/HOME CHARGING (120W)**

- Charge your Notebook with this Compact 120W Universal AC/DC Power Supply and Charger!
- This Charger Provides up to 120 Watts of Power, and included 8 Power Tips that are Compatible with Most Popular Laptops and Portable Devices



acer COMPAQ DELL hp IBM  
SONY TOSHIBA Lenovo FUJITSU



**120 Watts**

**DLPT-1015-LUB**

**SLIM UNIVERSAL AC ADAPTER**

- Input/Entrada: AC 100~240V, 50/60Hz
- Output/Salida: 15, 16, 18.5, 19, 19.5, 20V, 100W Max
- Compatible with/Compatible con: Acer, Asus, Dell, Hp, Lenovo, Samsung, Vivo, Toshiba

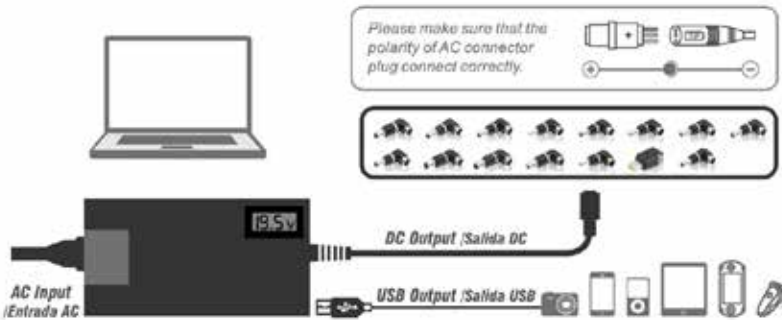

Please make sure that the polarity of AC connector plug connect correctly.



**DLPT-UNI-16**

**SMART UNIVERSAL POWER ADAPTER**

- Input: 110V~240V, 50/60Hz, 1.5A
- Output: 5.25V, 3A



Type/Tipo	Output/Salida	Connector Size/Tamaño del conector
A	5V/Max 16W	USB Type-C/USB Tipo-C
S	5V/Max 16W	Micro USB/USB Micro
C	5V/Max 16W	5.5 x 2.5mm
F	5V/Max 16W	4.8 x 1.7mm
G	5V/Max 16W	4.0 x 1.7mm
H	5V/Max 16W	3.5 x 1.35mm
I	5V/Max 16W	2.5 x 0.7mm
L	5V/Max 16W	3.0 x 1.0mm





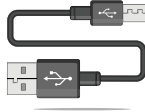

**DLPT-12-CIG90**

**DC LAPTOP CHARGER**

- Input: 10-15V DC Max 8A
- Output: 19V/19.5V/20V 90W MAX
- New slim universal charger for laptop, tablet, or ultrabook
- Compatible with all the 30W-90W laptops, tablets, or ultrabooks
- With smart chip switching voltage, unique mould with LED light on the tips to indicate if the car charger is working



**90 Watts  
Power**

TIP#	Output Voltage / Voltaje de Salida	DC Connector / Conector DC	Compatible Models / Modelos compatibles
K1	19-20V	7.9 x 5.5mm	IBM/LENOVO: 20V/3.25A, 20V/4.5A
K2H	18.5V-19.5V	7.4 x 5.0mm	HP: 18.5V/3.5A, 19.5V/3.33A, 19V/4.74A, 19.5V/4.62A
K3	19V-19.5V	6.5 x 4.4mm	LG/SONY: 19V/1.3A, 19V/1.7A, 19.5V/2A, 19.5V/3.33A, 19.5V/3.9A, 19.5V/4.7A
K4	19V	5.5 x 3.0mm	SAMSUNG: 19V/2.1A, 19V/3.16A, 19V/4.22A, 19V/4.74A
K5	19-20V	5.5 x 2.5mm	ASUS/LENOVO/FUJITSU/ACER: 19V/3.16A, 19V/3.42A, 19V/3.95A, 19V/4.74A, 20V/3.25A, 20V/4.5A
K6	19V	5.5 x 1.7mm	ACER: 19V/1.58A, 19V/2.15A, 19V/2.37A, 19V/3.42A, 19V/4.74A
K9D	19.5V	4.5 x 3.0mm	DELL: 19V/2.31A, 19.5V/3.34A, 19.5V/4.62A
K10H	19.5V	4.5 x 3.0mm	HP: 19.5V/2.31A, 19.5V/3.33A, 19.5V/4.62A
K11	19V	4.0 x 1.35mm	ASUS: 19V/1.75A, 19V/2.37A, 19V/3.42A
K12	19-20V	4.0 x 1.7mm	TOSHIBA/LENOVO: 19V/2.37A, 20V/3.25A, 20V/4.5A
K13	19V	3.0 x 1.0mm	ASUS/SAMSUNG: 19V/2.1A, 19V/2.37A, 19V/3.16A, 19V/3.42A
K14	19V	2.5 x 0.7mm	ASUS: 19V/1.58A, 19V/2.1A
K15D	19.5V	7.4 x 5.0mm	DELL: 19V/2.31A, 19.5V/3.34A, 19.5V/4.62A
K16	19-20V	USB Type/Tipo USB	IBM/LENOVO: 20V/2.25A, 20V/3.25A, 20V/4.5A
K17	18.5-19.5V	4.8 x 1.7mm	HP: 18.5V/3.5A, 19.5V/3.33A

**CV-USBVGA3-WID**

**USB 3.0 FEMALE TO VGA CONVERTER**

- Used to Connect a USB-Enabled Device (such as a Laptop or Desktop) with VGA-Enabled Device (Such as Monitor, Projector, or TV) for Multi Monitor Solution, Extend Working Space with Split. Screen, Mirroring Display, Etc.
- Supports Windows 10, 8.1, 8, 7, XP, Etc.
- USB 3.0 Supports: 1920 x 1080 (Max), USB 2.0 Supports: 800 x 600.



**Installation Driver  
INCLUDED**

COMPUTER  
ACCESSORIES

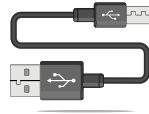

ACCESSORIES

IBM-WR400ANT

WIRELESS REPEATER

- Frequency Range: 2.412-2.4835 GHz
- The Wireless Power: 15-18 dBm
- Receiver Sensitivity:  
 300M: -68 dBm @ 10% PER  
 270M: -68 dBm @ 10% PER  
 130M: -68 dBm @ 10% PER  
 108M: -68 dBm @ 10% PER  
 54M: -68 dBm @ 10% PER  
 11M: -85 dBm @ 8% PER  
 6M: -88 dBm @ 10% PER  
 1M: -90 dBm @ 8% PER
- Antenna: 2 x 5 dBi Antennas
- Power: Input 100-240V AC; 50/60Hz
- Use Environment:  
 Work Temperature: 0 °C ~ 40 °C  
 Work Humidity: 10% ~90% RH Non-Condensing  
 Storage Temperature: -40 °C ~ 70 °C  
 Storage Humidity: 5%~90% RH Non-Condensing

300Mbps  
100V-240V



IBM-AWR3002.4

WIRELESS ROUTER

- Power: 5V 1A
- 300Mbps Wireless Speed Ideal for Interruption Sensitive Applications like HD Video Streaming
- Two Antennas Greatly Increase the Wireless Robustness and Stability



300Mbps  
100V-240V



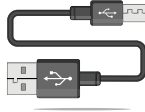

### IBM-WR800-2.4G

300MBPS CEILING AP 802.11B/G/N WIRELESS ACCESS  
POINT POE COVERAGE ROUTER LONG RANGE WIFI  
REPEATER ANTENNA FOR HOTEL/HOME WIFI

- Ceiling-Mount Design Blends into Environments
- 500mw High Power Design to Boost your Signal Coverage and Link Speed
- 24V Power over Ethernet for 70 Meters Flexible Deployment
- Gateway/AP/Repeater/WDS/WISP Mode Supported



### MAR-LT200

LAPTOP BRACKET

- Black Spray-Painted Iron
- Height & Width Adjustable
- Fix with Screwed Clamp



Clamps for DJ  
Flight Case



Base for DJ Table





***2022 CATALOG***





## CAR SPEAKERS

### XGT-1402

#### 4" 2-WAY IMPP CONE COAXIAL CAR SPEAKER

- 100 Watts (P.M.P.O.)
- 50 Watts (R.M.S.)
- Frequency Response: 80Hz~18KHz
- Sensitivity: 88dB / W(IM)
- Impedance: 4 Ohm

4"

100 Watts



### XGT-1502

#### 5-1/4" 2-WAY IMPP CONE COAXIAL CAR SPEAKER

- 200 Watts (P.M.P.O.)
- 100 Watts (R.M.S.)
- Frequency Response: 75Hz~18KHz
- Sensitivity: 89dB / W(IM)
- Impedance: 4 Ohm

5-1/4"

200 Watts



### XGT-1602

#### 6" 2-WAY IMPP CONE COAXIAL CAR SPEAKER

- 300 Watts (P.M.P.O.)
- 150 Watts (R.M.S.)
- Frequency Response: 70Hz~18KHz
- Sensitivity: 89dB / W(IM)
- Impedance: 4 Ohm

6" / 6.5"

300 Watts



Universal 6" / 6.5" Basket



## CAR SPEAKERS

### XGT-1600

6" DUAL CONE IMPP CONE CAR SPEAKER

- 150Watts (P.M.P.O.)
- 75Watts (R.M.S.)
- Frequency Response: 70Hz~15KHz
- Sensitivity: 89dB / W(IM)
- Impedance: 4 Ohm

6"/6.5"

150 Watts



### XGT-1603

6" 2-WAY IMP CONE COAXIAL CAR SPEAKER

- 350Watts (P.M.P.O.)
- 175Watts (R.M.S.)
- Frequency Response: 70Hz~18KHz
- Sensitivity: 89dB / W(IM)
- Impedance: 4 Ohm

6"/6.5"

350 Watts



Universal 6" / 6.5" Basket

### XGT-1605

5-1/2" DUAL CONE CAR SPEAKER

- 60Watts (P.M.P.O.)
- 30Watts (R.M.S.)
- Frequency Response: 150Hz~12KHz
- Sensitivity: 90dB / W(IM)
- Impedance: 4 Ohm

5-1/2 In

60 Watts





## CAR SPEAKERS

### XGT-6803

6" X 8" 3-WAY IMPP CONE TRIAXIAL CAR SPEAKER

- 350 Watts (P.M.P.O.)
- 175 Watts (R.M.S.)
- Frequency Response: 70Hz~20KHz
- Sensitivity: 89dB / W(IM)
- Impedance: 4 Ohm

**350 Watts**



### XGT-6903

6" X 9" 3-WAY IMPP CONE TRIAXIAL CAR SPEAKER

- 400 Watts (P.M.P.O.)
- 200 Watts (R.M.S.)
- Frequency Response: 60Hz~18KHz
- Sensitivity: 90dB / W(IM)
- Impedance: 4 Ohm

**400 Watts**





## CAR SPEAKERS

### XFG-1603

6" 3-WAY IMPP CONE TRIAXIAL CAR SPEAKER

- 300Watts (P.M.P.O.)
- 150Watts (R.M.S.)
- Frequency Response: 90Hz~18KHz
- Sensitivity: 86dB/W(IM)
- Impedance: 4 Ohm

6"/6.5"

300 Watts



Universal 6" / 6.5" Basket

### XFG-6903

6" X 9" 3-WAY IMPP CONE TRIAXIAL CAR SPEAKER

- 350Watts (P.M.P.O.)
- 175Watts (R.M.S.)
- Frequency Response: 55Hz~18KHz
- Sensitivity: 87dB/W(IM)
- Impedance: 4 Ohm

6x9 In

350 Watts



### XFG-6904

6"X9" 4-WAY IMPP CONE QUAD-AXIAL CAR SPEAKER

- Output Power:  
450Watts (P.M.P.O.)  
225Watts (R.M.S.)
- Frequency Response: 55Hz~18KHz
- Sensitivity: 88dB/W(IM)
- Impedance: 4 Ohm

6x9 In

450 Watts







## CAR SPEAKERS

### XTC-3300

SUPER HIGH -FREQUENCY MINI TWEETER

- 500 Watts
- Frequency Response: 5KHz~20KHz
- Sensitivity: 97dB
- Outout Power: 160 Watts

**500 Watts**



### XTC-5500

SUPER HIGH -FREQUENCY MINI TWEETER

- 500 Watts
- Frequency Response: 5KHz~20KHz
- Sensitivity: 100dB
- Outout Power: 120 Watts

**500 Watts**



### XTC-7700

SUPER HIGH -FREQUENCY MINI TWEETER

- 600 Watts
- Frequency Response: 5KHz~20KHz
- Sensitivity: 100dB
- Impedance: 4 Ohm

**600 Watts**





**SPEAKER BOXES**

**KIC-80**

**DUAL 8" WOOFER ENCLOSURE**

- 2" x 5" Piezo Tweeters (2 Pcs.)
- Carpet Finish
- Impedance: 4 Ohms
- Frequency Response: 45Hz-20KHz
- Sensitivity: 88dB (1W/ 1M)
- Size: 11-3/5" x 27-1/2" x 7-1/2"
- Weight: 17.5 lbs.
- Peak Power: 250 Watt

*Great for Hatchback & Single Cab Pickup Trucks*



**250 Watts**

**KIC-100**

**DUAL 10" WOOFER ENCLOSURE**

- 2" x 5" Piezo Tweeters (2 Pcs.)
- Carpet Finish
- Impedance: 4 Ohms
- Frequency Response: 40Hz-20KHz
- Sensitivity: 89dB (1W/ 1M)
- Size: 12-3/5" x 29-1/2" x 8"
- Weight: 36 lbs.
- Peak Power: 250 Watt

*Great for Hatchback & Single Cab Pickup Trucks*



**250 Watts**



## SPEAKER BOX KITS

### KIC-120

#### DUAL 12" WOOFER ENCLOSURE

- 2" x 5" Piezo Tweeters (2 Pcs.)
- Carpet Finish
- Impedance: 4 Ohms
- Frequency Response: 35Hz-20KHz
- Sensitivity: 88dB (1W/ 1M)
- Size: 15-1/8" x 33" x 8"
- Weight: 28.5 lbs.
- Peak Power: 500 Watt

*Great for Hatchback & Single Cab Pickup Trucks*



# 500 Watts

### XEQ-700

#### SLIM MOUNT EQUALIZER

- Frequency Response: 20Hz~20KHz
- Pre Graphic Frequency: 40Hz, 200Hz, 200Hz, 2KHz, 20KHz
- Total Harmonic Distortion(TDH): 0.05%
- Signal-to-noise Ratio: >80dB
- Inputs: Switchable to Ratio or Aux
- Equalization Boost/Cut: ±12dB
- Subwoofer Crossover Frequency: Selectable 80 or 120Hz
- Channel Separation: 70dB
- Maximum Output Voltage: 9V RMS
- Power Supply: 11~15V Negative Ground
- Fuse: 1A(AGC type)
- Dimensions: Chassis 6.75" x 1.125" x 4.25"
- Mounting Depth: 4.5"(Including RCA Jacks)



# 9V





**XCAP-2000**

**POWER CAPACITOR**

- VCD: 20 Max, 24V Surge
- ESR: 0.002  $\Omega$  or less
- Terminals: 1/4~28 Thread
- Digital Display & Status Indicator
- Digital Electronic Protection



**2 FARAD**



**XCAP-3500**

**POWER CAPACITOR**

- VCD: 20 Max, 24V Surge
- ESR: 0.002  $\Omega$  or less
- Terminals: 1/4~28 Thread
- Digital Display & Status Indicator
- Digital Electronic Protection



**3.5 FARAD**



**XTM-200**

**2 CHANNEL IC AMPLIFIER**

- Power: 200W Max @ 4 $\Omega$  Mono
- Frequency Response: 20Hz~20KHz
- Variable Bass Boost: 0~12dB @ 45Hz
- Channel Separation: 60dB
- Signal Noise Ratio: 90dB
- Input Impedance: 22K $\Omega$
- Input Sensitivity: 200mV~6V
- THD: <0.05%
- Dimensions: 4.3" x 5.9" x 2"  
(110x150x50mm)





### **XTM-400**

#### **4 CHANNEL IC AMPLIFIER**

- Power: 400W Max @ 4Ω Stereo
- Frequency Response: 20Hz~20KHz
- Selectable Crossover: LPF, FULL
- Channel Separation: 60dB
- Signal Noise Ratio: 90dB
- Input Impedance: 22KΩ
- Input Sensitivity: 200mV~6V
- THD: <0.05%
- Dimensions: 4.3" x 5.9" x 2"  
(110x150x50mm)



### **XMOTO-200**

#### **2 CHANNEL MINI AMPLIFIER**

- Max Power: 200W Max
- RMS Power: 2 x 25W @ 4Ω
- Frequency Response: 20Hz~20KHz
- Signal Noise Ratio: 90dB
- Output Impedance: 4Ω
- DC Power: 211.5~14.4V
- THD: <1.3%
- Dimensions: 4.3" x 3.1" x 1.6"  
(110 x 80 x 40mm)
- RCA Input/High Input
- Remote turn On/Off
- Easy to connect
- 3.5mm Plug Input



# AUDIO DRIFT

## 2022 CATALOG



### KDC-10001AM

#### 10.1" FULL CAPACITIVE DOUBLE DIN TILTING MULTIMEDIA PLAYER

- Screen Dimension: 10.1" full touch screen
- Screen Resolution: 1024 x 800 high definition
- Solution: 8288H Solution
- Detachable Screen
- Compatible with DVD, DVD-R, DVD-RW, DIVX(MPEG4), VCD, MP3, CD, CD-R, CD-RW
- Electronic tuning stereo FM radio tuner: 18 FM channels / 12 AM channels
- MMC Card / Big USB port / Front AUX-In
- Supports Audio/Video Input/Output
- Wireless hands free function (AZDP)
- Electric Encoder Audio Control: Volume, Bass, Treble, Balance, Fader
- Multiple Preset EQ: Jazz, Rock, Pop, Classic
- Steering Wheel Control
- RCA rear view camera input
- Super machine anti-shock technique (ESP Electric System)
- Charge function for mobile phone or other USB devices
- Wireless Remote Control
- Power Output: 50 x 4 Watts
- Supports 1080P high resolution video



15° TILT & SWIVEL IN ALL DIRECTIONS



INCLUDES  
WIRELESS  
REMOTE



### KD-MIC01

#### MICROPHONE ACCESSORY FOR MULTIMEDIA PLAYERS

- 76" Cable Length
- Clip Included
- 3.5 mm Jack



Universal Multimedia Entertainment Systems  
Microphone Accessory Compatible With this models:

- KDC-10001AM
- KDC-6050A
- KDC-6247AD
- KDC-6051K
- KDC-6251D

### KDC-6051K

#### 6.2" FULL CAPACITIVE MULTIMEDIA PLAYER

**NEW**

- Screen Dimension: 6.2" TFT full touch screen
- Screen Resolution: 800 x 480 high definition
- Supports 1080P high resolution video
- Compatible with DVD, DVD-R, DVD-RW, DIVX-(MPEG4), VCD, MP3, CD, CD-R, CD-RW
- Electronic tuning stereo FM radio tuner: 18 FM channels / 12 AM channels
- MMC Card / Big USB port / Front AUX-In
- Supports Audio/Video Input/Output
- Wireless hands free function (A2DP)
- Electric Encoder Audio Control: Volume, Bass, Treble, Balance, Fader
- Multiple Preset EQ: Jazz, Rock, Pop, Classic
- Steering Wheel Control
- RCA rear view camera input
- Super machine anti-shock technique (ESP Electric System)
- Charge function for mobile phone or other USB devices
- Wireless Remote Control
- Power Output: 50 x 4 Watts
- Supports mirror link function



### KDC-6247AD

#### 6.2" CAPACITIVE TOUCH SCREEN MULTIMEDIA PLAYER

- 6.2" TFT full touch screen
- Screen Resolution: 1024 x 800 high definition
- Compatible with DVD, DVD-R, DVD-RW, DIVX, VCD, MP3, CD, CD-R, and CD-RW
- Electronic tuning stereo FM radio tuner, 18 FM channels, 12 AM channels
- MMC Card, big USB port, front AUX-in
- Supports audio/video input/output
- Wireless hands free function
- Volume, Bass, Treble, Balance, Fader control
- EQ Jazz, Rock, Pop, Classic presets
- Steering wheel control
- RCA rear view camera input
- Charge function for mobile phone or other USB devices
- Wireless remote control
- Power Output: 50W x 4
- Supports 1080P high resolution video
- Supports mirrorlink function for Android phone



**INCLUDES WIRELESS REMOTE**





## KDC-6251D

**CAPACITIVE SCREEN CAR DVD/MP4 PLAYER WITH WIRELESS/USB/MMC/FM**

- 2 Din Multimedia Receiver with Motorised Full Touch Screen 6.2" TFT panel with Dynamic Graphic user Interface
- DVD/DIVX/VCD/WMA/MP3 (ID3 Tag)/CD/R/RW Compatible with Electronic Anti-skip Protection
- PLL Synthesized Electronic Tuning Stereo AM/FM
- Presets 30FM, Station Seek, Preset Scan
- MMC Card/Mini USB port (USB Adapter Cable Supplied)
- Wireless Hads Free Function
- Full Function Wireless Infrared Remote Control
- TFT Screen supporting True Color with 1440 x 234 High Resolution
- Electronic Encoder Audio (Volume/Bass/Treble/Balance/Fader) Control
- Selectable EQ Curves - Pop, Rock, Classic, Jazz & User
- Front Aux-input for connection to any portable device
- 45 Watts (max) 4 Channel High Output Power





## MULTIMEDIA PLAYERS

### KPD-1935BT

#### MULTIMEDIA CAR RADIO WITH CD PLAYER

- Compatible CD / HDCD / CD-R / CD-RM / CD / MP3 / DVD / MP4 multiple format.
- Electronic Audio Control (VOL / BAS / TRE / BAL / FAD).
- Electronic turning stereo FM radio tuner, 18 FM channels.
- USB / SD / MMC slot.
- Front/Rear AUX in.
- RCA line out.
- Multiple preset EQ: ROCK/POP/CLASSIC.
- Supports pause / preview / repeat / random play.
- Supports breakpoint and ID3 play.
- Digital clock display.
- Charge function for mobile phone or other USB devices.
- Wireless remote control.
- Super machine anti-shock technique (ESP Electronic System).
- Power output: 50W X 4.
- Built-in Wireless music stream.
- 12 AM / 18FM channels.



NOW WITH DVD PLAYER



INCLUDES WIRELESS REMOTE



### KPD-1957IBT

#### MULTIMEDIA CAR RADIO WITH CD PLAYER AND MULTI-COLOR ILLUMINATION

- Multi-color illumination
- Compatible CD / HDCD / CD-R / CD-RM / MP3 / MP4 multiple format.
- Electronic Audio Control (VOL / BAS / TRE / BAL / FAD).
- Electronic turning stereo FM radio tuner, 18 FM channels.
- USB / SD / MMC slot.
- 3.5mm AUX in.
- 1 Rear RCA line out.
- Multiple preset EQ ROCK/POP/CLASSIC.
- Supports pause / preview / repeat / random play.
- Supports breakpoint and ID3 play.
- Digital clock display.
- Charge function for mobile phone or other USB devices.
- Wireless remote control.
- Super machine anti-shock technique.
- Power output: 50W X 4.
- Built-in Wireless music stream.
- 12 AM / 18FM channels.



NOW WITH DVD PLAYER



INCLUDES WIRELESS REMOTE



## KP-1737BT

### MULTIMEDIA CAR RADIO

- With BT Function
- Fix Panel
- AM / FM Receiver
- USB/SD/MMC Slot
- Esp Electronic System
- Preset EQ (JAZZ / POP / ROCK / CLASS / FLAT)
- 30 Presets Memory (18 FM, 12AM)
- Last Memory / Preset Scan
- Power Output: 50W x 4
- Digital Clock Display
- Full Function Remote Control



## KP-1757IBT

### MULTIMEDIA CAR RADIO WITH MULTI-COLOR ILLUMINATION

- Multi-color illumination
- With BT Function
- Front/Rear RCA output
- Fix Panel
- AM/FM Receiver
- USB/SD/MMC Slot
- Esp Electronic System
- Preset EQ (JAZZ/POP/ROCK/CLASS/FLAT)
- 30 Presets Memory (18FM, 12AM)
- Last Memory/Preset Scan
- Power Output 50W x 4
- Digital Clock Display
- Full Function Remote Control



## KP-1757DFB

### SINGLE DIN MULTIMEDIA PLAYER W/ DETACHABLE FACE

- Detachable face
- Compatible CD / HDCD / CD-R / CD-RM / MP3 / MP4 multiple format.
- With BT Function
- Fix Panel
- AM/FM Receiver
- USB Slot
- Esp Electronic System
- Preset EQ (JAZZ/POP/ROCK/CLASS/FLAT)
- 30 Presets Memory (18FM, 12AM)
- Last Memory/Preset Scan
- Power Output 50W x 4
- Digital Clock Display
- Full Function Remote Control





## CAR SPEAKERS

### DS-A1683S

#### 6-1/2" 4-WAY FLUSH-MOUNT CAR SPEAKERS

- Injection Cone Woofer with Rubber Edge
- 4-Way IMPP Cone Car Speaker
- Output Power: 350 Watts (P.M.P.O.) / 175 Watts (R.M.S.)
- Frequency Response: 70Hz - 20KHz
- Sensitivity: 90dB/W(l)
- Impedance: 4 Ohms
- 6-1/2" Coaxial 4-Way



### DS-A1373S

#### 5-1/4" 3-WAY FLUSH-MOUNT CAR SPEAKER

- Injection Cone Woofer with Rubber Edge
- 3-Way IMPP Cone Car Speaker
- 200 Watts (P.M.P.O.)
- 100 Watts (R.M.S.)
- Frequency Response: 75Hz - 18KHz
- Sensitivity: 88dB/W(l)
- Impedance: 4 Ohms
- 5-1/4" Coaxial 3-Way



### DS-A1073S

#### 4" 3-WAY FLUSH-MOUNT CAR SPEAKER

- Injection Cone Woofer with Rubber Edge
- 3-Way IMPP Cone Car Speaker
- 200 Watts (P.M.P.O.)
- 100 Watts (R.M.S.)
- Frequency Response: 75Hz - 18KHz
- Sensitivity: 88dB/W(l)
- Impedance: 4 Ohms



## CSB-6900

### 6" X 9" 3-WAY CAR SPEAKER BOX

- 1" Aluminum Voice Coil
- 200z Magnet
- 58mm Paper Midrange
- 13.5mm Piezo & 20mm Piezo
- Impedance: 4 Ohms
- Frequency Response: 29Hz ~ 20KHz
- Sensitivity: 89dB
- Dimensions: 12" x 10-3/4" x 8"
- Weight: 7.5 lbs

**NEW**



## DS-A6993S

### 6" X 9" 4-WAY CAR SPEAKER

- Injection Cone Woofer with Rubber Edge
- 55mm Paper Midrange
- 20mm Piezo Tweeter & 13mm Piezo Tweeter
- 1" ASV Coil
- 200z Magnet
- 4 Ohm Impedance
- 200W Max Power



## DS-A6873S

### 6" X 9" IMPP CONE TRIAXIAL CAR SPEAKERS

- Injection Cone Woofer with Rubber Edge
- 3-Way Speaker
- 350 Watts (P.M.P.O.)
- 175 Watts (R.M.S.)
- Frequency Response: 70Hz - 20KHz
- Sensitivity: 89dB
- Impedance: 4 Ohms





## MOUNT CAR SPEAKERS / GRAPHIC EQUALIZER

### DS-AI373S

#### 5-1/4" 3-WAY FLUSH-MOUNT CAR SPEAKER

- Injection Cone Woofer with Rubber Edge
- 3-Way IMPP Cone Car Speaker
- 200 Watts (P.M.P.O.)
- 100 Watts (R.M.S.)
- Frequency Response: 75Hz - 18KHz
- Sensitivity: 88dB/W(1)
- Impedance: 4 Ohms
- 5-1/4" Coaxial 3-Way



### DEQ-500

#### 4-BAND GRAPHIC EQUALIZER WITH SUBWOOFER OUTPUT

- Independent adjustable input gain controls on radio and CD channels
- 0-18 dB boost/cut at center frequencies: 40 Hz (low), 150 Hz (low-mid), 1 kHz (mid) and 20 kHz (high)
- EQ center frequencies: 40Hz / 150Hz / 1kHz / 20kHz
- Equalization range: +/- 18dB (boost/cut)
- Frequency Response: 20Hz - 20kHz
- Subwoofer crossover frequency: variable 30-250Hz
- Signal-to-noise ratio: 105dB
- EQ THD: < 0.05%
- Subwoofer channel THD: < 0.05%
- Channel separation: 60dB
- Power supply: 10-16 V negative ground
- Outer voltage: 7V
- Dimensions: 6.8" x 4.25" x 1.1"



**Master  
Volume  
Control**

**Pre-amp  
Fader  
Control**

**24KT  
Gold-Plated  
RCA Input  
connectors**

**Subwoofer  
Volume  
Control**

**Radio/AUX  
Input  
Selector**

**Dual  
Color  
Illumination**

### ADS-TW-55

#### SUPER HIGH FREQUENCY MINI TWEETER

- 500 Watts power (P.M.P.O)
- 250 Watts power (R.M.S)
- Reinforced ABS grill
- Plastic grill allows for all weather use
- Adhesive strip included for easy installation
- Tweeter size: 1.5" x 1.5"
- Surface Mount

500  
Watts



### ADS-250

#### PIEZO TWEETER

- Frequency Range: 5 - 20K Hz
- Sensitivity: 105dB (1W/1M)
- Power: 500W Max
- Impedance: 4-8 Ohm
- Surface mount
- Size: 1 3/4" x 1" (45 x 24mm)

500  
Watts



# Pipedream

**2022 CATALOG**





### NL-LBC352

#### 52" CURVED LED LIGHT BAR

- Beam: Spot-Flood Combo
- Operating Voltage: DC 10-30V
- Power: 288W (96 x 3W/pcs high intensity LEDs)
- Color Temperature: 6000K
- Lumen: 22000LM
- Lifespan: >30,000 hours
- Waterproof Rate: IP 67
- Lens Material: PC
- Housing Material: Diecast Aluminum
- Dimensions (LxWxH): 52" x 3.3" x 3"

52 In  
288 Watts

ALL NL-LBR LED LIGHT BARS INCLUDE MOUNTING & INSTALLATION HARDWARE



### NL-LBC354

#### 54" CURVED LED LIGHT BAR

- Beam: Spot-Flood Combo
- Operating Voltage: DC 10-30V
- Power: 300W (100 x 3W/pcs high intensity LEDs)
- Color Temperature: 6000K
- Lumen: 22000LM
- Lifespan: >30,000 hours
- Waterproof Rate: IP 67
- Lens Material: PC
- Housing Material: Diecast Aluminum
- Dimensions (LxWxH): 54" x 3.3" x 3"

54 In  
300 Watts

With a curved light bar, you will still be able to get the same combo patterns with the same basic idea. However, this will disperse the light even wider. The curved light bar will give you the widest field of view, allowing you to illuminate the largest area possible.

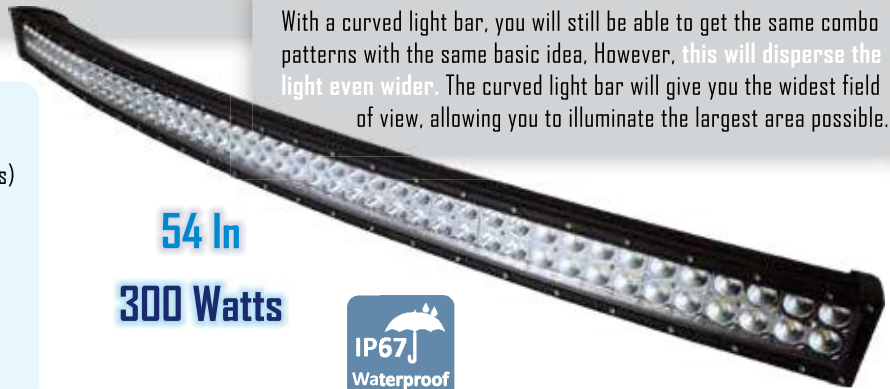

### NL-LBR353-288W

#### 53" LED LIGHT BAR

- Beam: Spot-Flood Combo
- Operating Voltage: DC 10-30V
- Power: 288W (96 x 3W/pcs high intensity LEDs)
- Color Temperature: 6000K
- Lumen: 22000LM
- Lifespan: >30,000 hours
- Waterproof Rate: IP 67
- Lens Material: PC
- Housing Material: Diecast Aluminum
- Dimensions (LxWxH): 53" x 3.3" x 3"

53 In  
288 Watts

All of our NL-LBR Led Light Bars can be used on any Vehicle, ATV, Boat, Tractor or other heavy equipment. It uses the latest LED Technology, supplying superior light output and optimum energy efficiency.

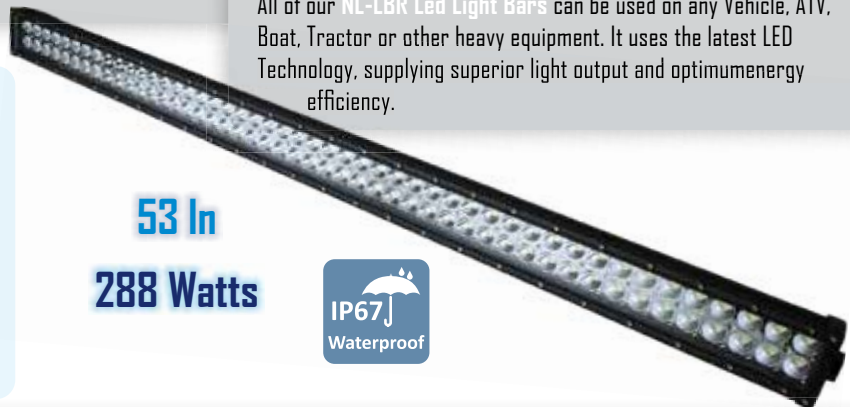

### NL-LBR355-300W

#### 55" LED LIGHT BAR

- Beam: Spot-Flood Combo
- Operating Voltage: DC 10-30V
- Power: 300W (100 x 3W/pcs high intensity LEDs)
- Color Temperature: 6000K
- Lumen: 22000LM
- Lifespan: >30,000 hours
- Waterproof Rate: IP 67
- Lens Material: PC
- Housing Material: Diecast Aluminum
- Dimensions (LxWxH): 55" x 3.3" x 3"

55 In  
300 Watts





**LED LIGHT BARS**

**NL-LBR325-120W**

**25" LED LIGHT BAR**

- Beam: Spot-Flood Combo
- Operating Voltage: DC 10-30V
- Power: 120W (40 x 3W/pcs high intensity LEDs)
- Color Temperature: 6000K
- Lumen: 22000LM
- Lifespan: >30,000 hours
- Waterproof Rate: IP 67
- Lens Material: PC
- Housing Material: Diecast Aluminum
- Dimensions (LxWxH): 25" x 3.3" x 3"



**25 In**  
**120 Watts**



**NL-LBR333-180W**

**33" LED LIGHT BAR**

- Beam: Spot-Flood Combo
- Operating Voltage: DC 10-30V
- Power: 180W (60 x 3W/pcs high intensity LEDs)
- Color Temperature: 6000K
- Lumen: 22000LM
- Lifespan: >30,000 hours
- Waterproof Rate: IP 67
- Lens Material: PC
- Housing Material: Diecast Aluminum
- Dimensions (LxWxH): 33" x 3.3" x 3"



**33 In**  
**180 Watts**



**NL-LBR317-72W**

**17" LED LIGHT BAR**

- Beam: Spot-Flood Combo
- Operating Voltage: DC 10-30V
- Power: 288W (96 x 3W/pcs high intensity LEDs)
- Color Temperature: 6000K
- Lumen: 22000LM
- Lifespan: >30,000 hours
- Waterproof Rate: IP 67
- Lens Material: PC
- Housing Material: Diecast Aluminum
- Dimensions (LxWxH): 53" x 3.3" x 3"



**17 In**  
**72 Watts**



**ALL NL-LBR LED LIGHT BARS INCLUDE MOUNTING & INSTALLATION HARDWARE**



**NL-LBMX382-25W**

**8" TRIPLE ROW 40 OFF-ROAD LED LIGHT**

- Beam: Spot
- Voltage: 10 - 30V DC
- Waterproof: IP67
- LED Chips: 0.9W Epistar
- Color Temperature: 6000K
- Material: Diecast Aluminum Housing
- Lens Material: PC Lens
- Mounting Bracket: Aluminum Firm Bracket and Stainless Steel Screws
- Span Life: >30,000 Hours
- Dimensions (LxWxH): 8" x 3.3" x 3"
- Mounting Hardware Included



**8 In**  
**25 Watts**



### NL-LBS36-18W

#### 6" 18W LED MINI LIGHT BAR

**BEST SELLER**

This high quality mini light bar has 6 CREE LED bulbs with intense brightness up to 1530 lumens and is housed in diecast Aluminum

- Voltage: DC 10-30V
- Power: 18W
- 6 Pcs x 3W High Intensity LEDs
- Luminous Flux: 1530 LM
- Color Temperature: 6000K
- Service Life: 50000h
- Waterproof Rate: IP67
- Material: Aluminum Alloy
- Dimensions (LxWxH): 6" x 1.7" x 1.8"
- Mounting Hardware Included

**6 In**  
**18 Watts**



### NL-LBS326-72W

#### 26" LED LIGHT BAR

- Voltage: DC 10-30V
- Power: 72W (24pcs x 3W high intensity LEDs)
- Luminous Flux: 1530 LM
- Color Temperature: 6000K
- Service Life: 50000h
- Waterproof Rate: IP67
- Material: Aluminum alloy
- Dimensions (LxWxH): 26" x 1.8" x 1.2"
- Mounting Hardware Included

**26 In**  
**72 Watts**



### NL-LB303-18W

#### 3" 12W CREE LED LIGHT BAR

- Description: Cree LED Light Bar
- Operation Voltage: 10-30V DC
- LED Module: 3W/pcs Cree LEDs
- LENS Material: Tempered Glass
- Beam: Spot, Flood, Combo
- Waterproof Level: IP67
- Color Temp.: 6000K~6500K
- Housing Material: Aluminum
- Life Span: >30,000 hours
- Sold in Pairs



### NL-LBSQ-33-10W

#### 3" 10W LED SPOT LIGHT

- Power: 10W
- Voltage: 10-30V DC
- Waterproof Rate: IP 67
- LED Chips: 2.5W Cree
- Color Temperature: 6000K
- Lumen: 880 LM
- Beam: Spot / Flood
- Span Life: 50000 Hours
- Dimensions (LxWxH): 3.25" x 3" x 3"
- Mounting Hardware Included

**10 Watts**



This spot Light gives you wide-area coverage. Designed for rigorous off-road use. The whole unit is IP67 rated to be dust-tight and withstand brief submersion. The spot light is easy to install with the supplied bracket.





**LIGHTINGS / ACCESSORIES**

**NL-LBSQ874D-10W**

**3" 10W LED SPOT LIGHT WITH 4D POLYCARBONATE LENS**

- Power: 10W
- Voltage: 10-30V DC
- Waterproof Rate: IP 67
- LED Chips: 2.5W Cree
- Color Temperature: 6000K
- Lumen: 880 LM
- Beam: Spot / Flood
- Span Life: 50000 Hours
- Dimensions (LxWxH): 3.25" x 3" x 3"
- Mounting Hardware Included

**10 Watts**



This spot Light uses a 4D PC lens that concentrates the light beams and creates an extremely powerful light visible in daytime



**NL-LBSQ-14-27W**

**4" 27W SQUARE LED FOG LIGHT**

- LED Light Color: White
- Voltage: 9V-36V
- Power: 27W (9pcs x 3W high intensity LEDs)
- Luminous Flux: 1980 LM
- Color temperature: 6000K
- Service Life: 30000h
- Material: Aluminum
- Bracket: Stainless steel bracket
- Waterproof Rate: IP67
- Size: 108 x 108 x 35mm / (4.3" x 4.3" x 1.4")



**NL-LBSQ-15-27W**

**5" 27W SQUARE LED FOG LIGHT**

- LED Light Color: White
- Voltage: DC 10-30V
- Power: 27W (9pcs x 3W high intensity LEDs)
- Luminous Flux: 1800 LM
- Color Temperature: 6000K
- Service Life: 30000h
- Material: Aluminum alloy
- Bracket: Stainless steel bracket
- Waterproof Rate: IP67
- Size: 4.5" x 4.5" x 1.2"



**NL-LBSTRQ-15-27W**

**5" 27W SQUARE LED FOG LIGHT**

- LED Light Color: White & Yellow (Flashing light)
- Voltage: DC 10-30V
- Power: 27W (9pcs x 3W high intensity LEDs)
- Luminous Flux: 1800 LM
- Color Temperature: 6000K
- Service Life: 30000h
- Material: Aluminum alloy
- Bracket: Stainless steel bracket
- Waterproof Rate: IP67
- Size: (4.5" x 4.5" x 1.8")
- With Amber LED Strobe Effect



**White & Amber LED**

### NL-LBRO-07-51W

#### 51W WORK LIGHT

- Power: 51W
- Voltage: 9-32V
- Waterproof Rate: IP67
- Color temperature: 6500K
- Lumen: 4000LM
- Beam: Spot/Flood Epistar
- Dimensions: 7" x 2.5" x 7.5" (LxWxH)



### NL-LBOV-43-20W

#### 20W LED WORK LIGHT

- Power: 20W
- Voltage: 9-32V
- Waterproof Rate: IP67
- Color Temperature: 6500K
- Lumen: 1400LM
- Beam: Spot/Flood
- Dimensions: 2 1/2" x 4"



### NL-HL-7243-72W

#### 72W LED HEADLIGHT

- Led Power: 72W
- LED Chip: 24PCS x 3W (hi/lo & DRL are Cree 3030)
- With (DRL) Daytime Running Lights
- Waterproof: IP67
- Lens: PMMA
- Beam: Flood \ Spotlight Combo
- Dimensions: 195 x 140 x 70 mm (7.7" x 5.5" x 2.8")



7 In

72 Watts



### NL-LBRT-45-20W

#### 45W LED HEADLIGHT

- Power: 45W
- LED type: 15PCS x 3W Epistar
- Beam: Hi/lo Beam
- Working Voltage: 10V-30V
- Lumen: 3375LM
- Waterproof: IP68
- Color Temperature: 6000K-7000K
- Material: Diecast Aluminum Housing
- Lens Material: PC
- Operating Temperature: -40°C ~ +80°C
- Lifespan: over 50,000 Hours Life
- Dimensions: 6 1/2" x 4 1/4"





# HEADLIGHTS

## NL-H-9007-36W

### SI LED HEADLIGHT-9007

- Power: 36 Watts per piece
- Voltage: 9-32V (fits 12V/24V vehicles)
- Lumen: 3600 LM
- Waterproof: IP67
- Easy one click Installation
- Secure temperature range up to 6500K
- With LED CSP beam



## NL-H-HI-36W

### HI LED HEADLIGHT

- Power: L/36W, H/36W - Voltage: 9V-32V DC
- Working Temperature: -40°C~ +85°C
- LED Type: CSP x 6 PCS (SINGLE BEAM), CSP x 12PCS(DOUBLE BEAM)
- Lumens: 4000LM
- Cooling System: Aviation Aluminum 6063
- Color Temperature: 6000K
- Waterproof: IP67
- Beam Angle: 360°
- Material: Aluminum Alloy
- Lifespan: 50,000hrs



## NL-H-H4-36W

### H4 LED HEADLIGHT

- Power: L/36W, H/36W - Voltage: 9V-32V DC
- Working Temperature: -40°C~ +85°C
- LED Type: CSP x 6 PCS (SINGLE BEAM), CSP x 12PCS(DOUBLE BEAM)
- Lumens: 4000LM
- Cooling System: Aviation Aluminum 6063
- Color Temperature: 6000K
- Waterproof: IP67
- Beam Angle: 360°
- Material: Aluminum Alloy
- Lifespan: 50,000hrs



## NL-H-H7-36W

### H5 LED HEADLIGHT

- Power: L/36W, H/36W - Voltage: 9V-32V DC
- Working Temperature: -40°C~ +85°C
- LED Type: CSP x 6 PCS (SINGLE BEAM), CSP x 12PCS(DOUBLE BEAM)
- Lumens: 4000LM
- Cooling System: Aviation Aluminum 6063
- Color Temperature: 6000K
- Waterproof: IP67
- Beam Angle: 360°
- Material: Aluminum Alloy
- Lifespan: 50,000hrs



## NL-H-H11-36W

### H11 LED HEADLIGHT

- Power: L/36W, H/36W - Voltage: 9V-32V DC
- Working Temperature: -40°C~ +85°C
- LED Type: CSP x 6 PCS (SINGLE BEAM), CSP x 12PCS(DOUBLE BEAM)
- Lumens: 4000LM
- Cooling System: Aviation Aluminum 6063
- Color Temperature: 6000K
- Waterproof: IP67
- Beam Angle: 360°
- Material: Aluminum Alloy
- Lifespan: 50,000hrs



## NL-H-H13-36W

### H13 LED HEADLIGHT

- Power: L/36W, H/36W - Voltage: 9V-32V DC
- Working Temperature: -40°C~ +85°C
- LED Type: CSP x 6 PCS (SINGLE BEAM), CSP x 12PCS(DOUBLE BEAM)
- Lumens: 4000LM
- Cooling System: Aviation Aluminum 6063
- Color Temperature: 6000K
- Waterproof: IP67
- Beam Angle: 360°
- Material: Aluminum Alloy
- Lifespan: 50,000hrs



## NL-H-9005-36W

### S1 LED HEADLIGHT-9005

- Power: 36 Watts per piece
- Voltage: 9-32V (fits 12V/24V vehicles)
- Lumen: 3600 LM
- Ideal for High Beam Reflector headlights
- Easy and click Installation
- Waterproof: IP67
- Secure temperature range up to 6500K
- With LED CSP beam
- Constant brightness output at all times



## NL-H-9006-36W

### S1 LED HEADLIGHT-9006

- Power: 36 Watts per piece
- Voltage: 9-32V (fits 12V/24V vehicles)
- Lumen: 3600 LM
- Enhanced light efficiency
- Waterproof: IP67
- Easy and click Installation
- Secure temperature range up to 6500K
- With LED CSP beam





# HEADLIGHTS

## NL-CAN-H-H11

**NEW**

### LED HEADLIGHT WITH CANBUS

- Power: L/36W, H/36W - Voltage: 12V-24V DC
- Working Temperature: -40°C~ +85°C
- LED Type: CSP x 6 PCS (SINGLE BEAM), CSP x 12PCS
- Lumens: 4000LM
- Cooling System: Aviation Aluminum 6063
- Color Temperature: 6000K
- Waterproof: IP67
- Beam Angle: 360°
- Material: Aluminum Alloy
- Lifespan: 50,000hrs



## NL-CAN-H-9005

**NEW**

### LED HEADLIGHT WITH CANBUS

- Power: L/36W, H/36W - Voltage: 12V-24V DC
- Working Temperature: -40°C~ +85°C
- LED Type: CSP x 6 PCS (SINGLE BEAM), CSP x 12PCS
- Lumens: 4000LM
- Cooling System: Aviation Aluminum 6063
- Color Temperature: 6000K
- Waterproof: IP67
- Beam Angle: 360°
- Material: Aluminum Alloy
- Lifespan: 50,000hrs



## NL-CAN-H-9006

**NEW**

### LED HEADLIGHT WITH CANBUS

- Power: L/36W, H/36W - Voltage: 12V-24V DC
- Working Temperature: -40°C~ +85°C
- LED Type: CSP x 6 PCS (SINGLE BEAM), CSP x 12PCS
- Lumens: 4000LM
- Cooling System: Aviation Aluminum 6063
- Color Temperature: 6000K
- Waterproof: IP67
- Beam Angle: 360°
- Material: Aluminum Alloy
- Lifespan: 50,000hrs



## NL-CAN-H-H4

**NEW**

### LED HEADLIGHT WITH CANBUS

- Power: L/36W, H/36W - Voltage: 12V-24V DC
- Working Temperature: -40°C~ +85°C
- LED Type: CSP x 6 PCS (SINGLE BEAM), CSP x 12PCS
- Lumens: 4000LM
- Cooling System: Aviation Aluminum 6063
- Color Temperature: 6000K
- Waterproof: IP67
- Beam Angle: 360°
- Material: Aluminum Alloy
- Lifespan: 50,000hrs





**NEW**

### NL-CAN-H-H7

#### LED HEADLIGHT WITH CANBUS

- Power: L/36W, H/36W - Voltage: 12V-24V DC
- Working Temperature: -40°C~ +85°C
- LED Type: CSP x 6 PCS (SINGLE BEAM), CSP x 12PCS
- Lumens: 4000LM
- Cooling System: Aviation Aluminum 6063
- Color Temperature: 6000K
- Waterproof: IP67
- Beam Angle: 360°
- Material: Aluminum Alloy
- Lifespan: 50,000hrs



### STRB-500

#### LED STROBE LIGHT

- 11-30VDC
- Waterproof
- 15 Flashing Patterns
- EZ-Switch Control
- Auto-Recall Function
- LED Flash Pattern Indicator
- Brightness Control Option
- Option (car alarm warning)





LED STRIPS

**NL-KT116LEDM**

7 COLOR FLEXIBLE LED STRIP

- 0.8cm Wide, 0.2cm Height
- Color: 7 Color
- Size: 16' / 480cm
- Clearly marked lines shows exactly where to cut
- 24 key super thin IR remote controller allows user to conveniently set colors and control patterns
- Create a stunning light show for your motorcycle, car, truck, boat or just about any application
- Includes ONE LED strip, harness, remote, extension, and control box



**NL-ACKT116LM**

FLIXIBLE AC/DC LED STRIP KIT WITH REMOTE

- Input: 100~240V
- 1.2cm Wide, 0.3cm High
- LED Quantity (1M): 60 LED's
- IP Class: IP65
- Color: RGB
- Size: 16.4'/5M
- AC/DC Adaptor Included
- Can be Cut every 3 LED's which is Equivalent to 2"
- Use it for Underbody Lighting, Engine Bay Lighting or Interior Lighting
- Will hold up in all Weather Conditions, Indoors/Outdoors
- So Flexible, it can Achieve 90 Degree Angle Bends



**NL-KT216LEDM**

**7 COLOR FLEXIBLE LED STRIP**

- 0.8cm Wide, 0.2cm Height
- Color: 7 Color
- Size: 16' / 480cm
- Clearly marked lines shows exactly where to cut
- 24 key super thin IR remote controller allows user to conveniently set colors and control patterns
- Create a stunning light show for your motorcycle, car, truck, boat or just about any application
- Includes TWO LED strip, harness, remote, extension, and control box

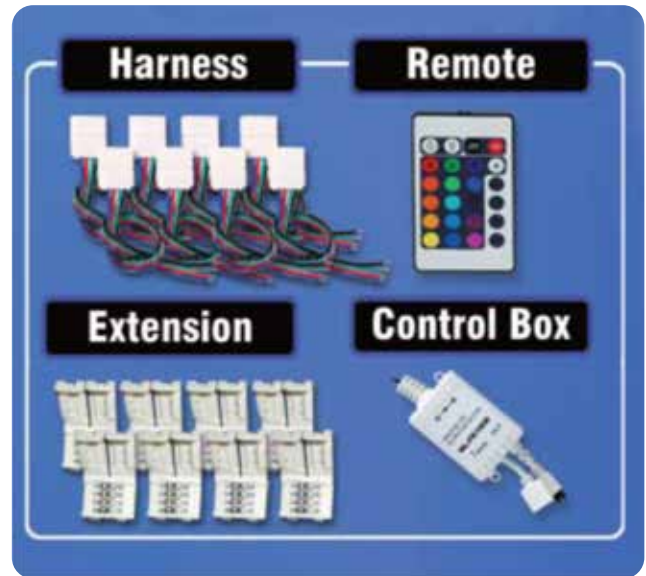



**AUTOMOBILE LIGHTING**

**NLTB-4860**

**48" LED TRUCK TAILGATE**

- Length: 48"
- 4 Pin Trailer Style Connector
- Also Lights up when Integrated with your truck's reverse lights
- Self-Adhesive Mounting Pads for Easy Installation
- Includes Mounting Hardware

**48 IN**



**NLTB-6060**

**60" LED TRUCK TAILGATE**

- Length: 60"
- 4 Pin Trailer Style Connector
- Also Lights up when Integrated with your truck's reverse lights
- Self-Adhesive Mounting Pads for Easy Installation
- Includes Mounting Hardware

**60 IN**



**Includes Mounting Hardware**



**IP 67 Waterproof**



**3 M Adhesive**



**4 Pin Connector**



**Driving  
Conducción**



**Brake  
Freno**



**Turn Left  
Gire a la Izquierda**



**Turn Right  
Gire a la Derecha**



**Backing up  
Retroseso**

## NL-S3648FLT

### FLEXIBLE SLIMLINE MULTICOLOR LED TUBE KIT

- Add an animated LED glow to your car
- 7 colors and 12 lighting sequences including sound activation mode
- A great kit for a novice or pro
- Control all lighting sequences from your key chain remote
- Easy connection block for wiring the system
- The LED tubes are encapsulated in impact and water resistant tubing
- 36" tubes have 81 LED's and 48" tubes have 108 LED's
- The softer flexible tube allows you to mount under an uneven chassis
- The kit includes:
  - (2) 48" Tubes and (2) 36" LED Tubes
  - (1) LED Controller Module
  - (1) Controller Board
  - (1) Remote Board
  - All Mounting Hardware



## NL-71LED-12V

### SPECTRA ACCESSORY KIT

- 7 selectable patterns
- Speed control
- 8 color patterns
- 4 single LED bulbs
- 2pcs 6" LED Tube
- 2pcs 9" LED Tube
- 1pc Control module with cigarette lighter adapter



Multiple RGB Colors Combinations





# AUTOMOBILE LIGHTING

## NL-F424WK

### 7 COLOR LED FENDER TRIM LIGHT

- Color: 7 Colors
- Size: 24"/61cm x 4 Pcs
- Dances to the beat of the music
- Easy Installation
- Selectable color
- Multiple changing patterns
- Illuminates the wheels well
- Flexible

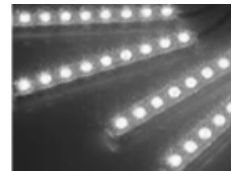

**LED-100BLU**

**LED SCANNER**

- With 7 Blue Micro Flashing LED's & 10 Different Selectable Patterns
- Super Bright LEDs, Long Lasting Shock
- Over 100,000 Hours Life
- Low Power Consumption, No Heat Build-Up
- Can be used in Conjunction with your Security Alarm as a Warning Light
- Installs with or without Car Alarm



**NL-SC710**

**3-COLOR LED SCANNER**

- With 7 Blue Micro Flashing LEDs
- Long Lasting Super Bright LEDs
- Over 100,000 Hours Life
- Low Power Consumption, no Heat Build-Up
- Can be used to Conjunction with your Security Alarm as a Warning Light
- Install with or without Car Alarm
- Can change between 7 different Patterns, and 3 Colors by Pressing Pinhole Button on Front of Scanner



**NLD-100**

**DIGITAL VOLTAGE METER**

- Range: 11.1~15.9V
- 3-Digit Display W/Turn-On Circuit



**NLD-300CLUBL**

**DIGITAL VOLTAGE METER WITH USB CHARGER**

- Voltage Meter: Monitor your Electrical Performance
- USB Charger: 1000 mA Quick Charger for Phone and Portable Devices
- 12V Plug: Standard Size to Work with all Vehicles





# MARINE LIGHTING/LED SPEAKER RINGS

## NL-RIAMP-8 RGB 8" RGB LED SPEAKER RINGS

- Smoke colored housing case
- Durable acrylic 12mm thickness
- Handles all outdoor weather conditions
- LEDs are pre-mounted and ready to install
- Outer edges are frosted for a consistent glow effect
- Inner ring diameter: 7-1/4"
- Outer ring diameter: 8-1/2"
- Made to fit APMP-8" die cast basket and APMP-8 ABS basket
- Sold in Pairs

The speaker rings are made of acrylic with a 12mm thickness. The outside edges are frosted for an evenly diffused glow effect. Each ring comes preinstalled with a weather proof quick-connection for easier installation.

8"



## MLDPC-24 FAMILY ADVANCED MARINE APPLICATION LED

- MLDPC-24WH ○
- MLDPC-24BL ●
- MLDPC-24RD ●

24 IN

- Waterproof IP 68
- 12-Volt DC Power Only
- This LED lights are polarity sensitive
- It is important the power and ground are connected properly
- Red wire = Positive / Black wire = Negative All Pipedream Lights operate with a very low power demand. This ensures the most from your battery supply. Power supply should not exceed 14 volt DC (Standard 12 volt DC system)

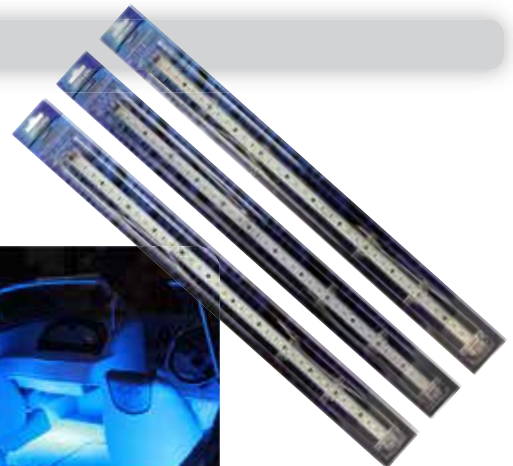





# MARINE LIGHTING/LED SPEAKER RINGS

## NL-RI-RGB FAMILY

### RGB LED SPEAKER RINGS

- NL-R16550-RGB 6.5" ● 5.75" x 7.675"
- NL-R18050-RGB 8" ● 7" x 8.5"
- NL-R11050-RGB 10" ● 9.125" x 11.125"

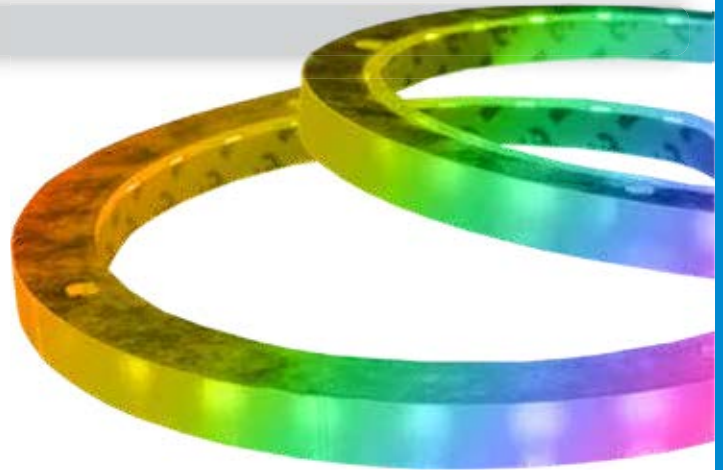

- Durable acrylic 12mm thickness
- Handle all outdoor weather environments
- LED's are pre-mounted and ready to install
- Rings are supplied with a weather-proof connector
- Outer edges are frosted for a consistent glow effect

## NL-RIAPMB FAMILY

### LED SPEAKER RINGS

- NL-RIAPMB 6" ● 5.75" x 7"
- NL-RIAPMB 6" ○

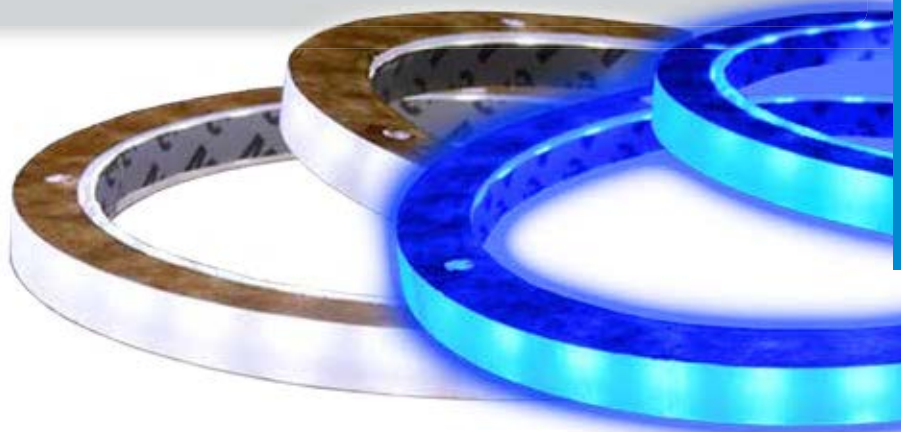

- UV protection
- Durable acrylic 12mm thickness
- Handles all outdoor weather environments
- LED's are pre-mounted and ready to install
- Rings are supplied with a weather proof connector
- Outer edges are frosted for a consistent glow effect

## NL-RI BLU/WHT FAMILY

### LED SPEAKER RINGS

- NL-R18850 BLU 8.8" ● } 7.25" x 8.75"
- NL-R18850 WHT 8.8" ○ } 7.25" x 8.75"
- NL-R11000 BLU 10" ● } 8.75" x 10.75"
- NL-R11000 WHT 10" ○ } 8.75" x 10.75"

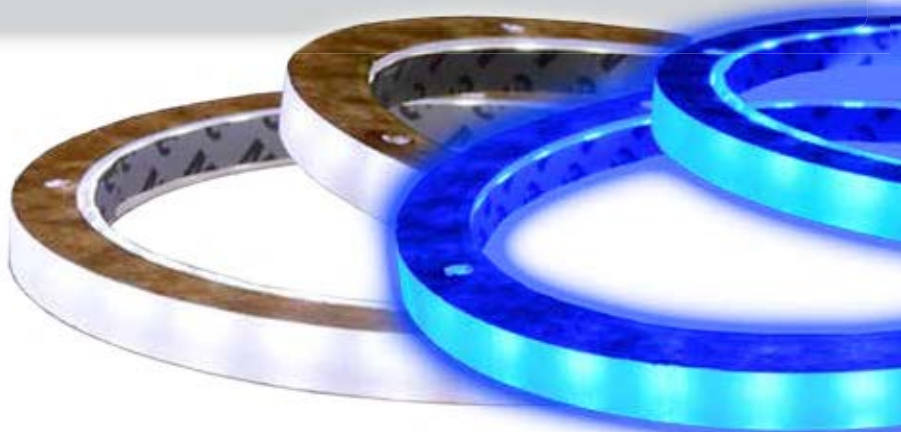

- UV protection
- Durable acrylic 12mm thickness
- Handles all outdoor weather environments
- LED's are pre-mounted and ready to install
- Rings are supplied with a weather proof connector
- Outer edges are frosted for a consistent glow effect



# MARINE LIGHTING/LED SPEAKER RINGS

## NL-BLESP-KT

### WIRELESS RGB LED CONTROLLER AND WIRING KIT

**NEW**

The NL-BLESP-KT Wireless RGB LED Controller and Wiring Kit allows you to create unique and custom LED lighting configurations for your boat. Easily connect up to 8 LED Strips, LED Speaker Rings, or Led Loudspeakers to the RGB LED Controller to create a synchronized and stunning LED illuminated display for your boat.

- (1) Wireless RGB LED Controller
- (8) 4-Pins 12ft Black Extension Cables
- (6) Y (1 to 2 Way) 8.5in Splitters
- Voltage: 12V DC
- Current:
- The controller uses advanced PWM (Pulse Width Modulation) digital control technology for precise and accurate color management. The controller can ONLY be operated using the LED phone app. This app is available for both IOS and Android.
- Water Resistant



## EASILY CONNECTS TO:

### LED SPEAKERS



### LED STRIPS



### LED SPEAKER RINGS

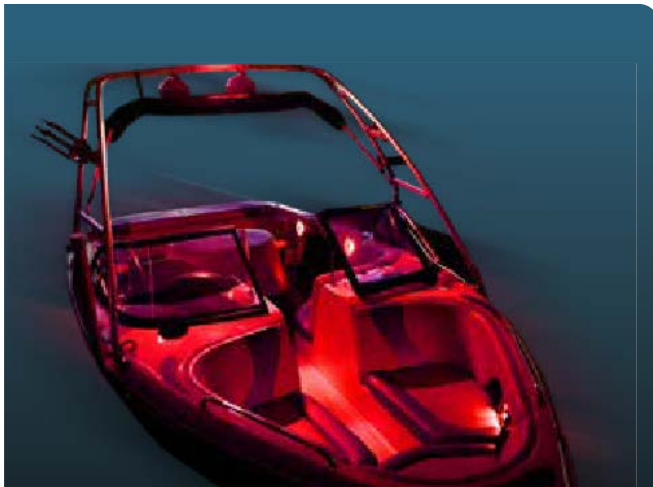

### PIPEDREAM LED APP

Wirelessly control the color, strobe pattern and speed of your LED's with the Pipedream LED mobile application available on the Apple App Store and Google Play for Android.

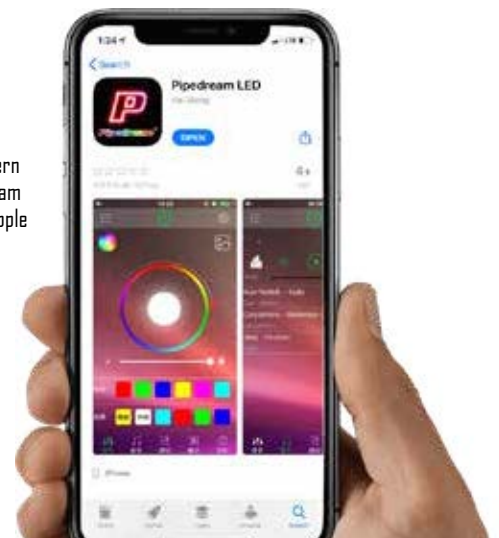

### NL-464-BTK

#### WIRELESS STREAM RGB LED CONTROLLER

- One RGB LED APP Controller with 4 Outputs with Connectors and Remote in Turn on Wire
- Extra 6" Extension Cables x 4
- Voltage: 12V DC, Current: 10A
- The controller uses advanced PWM (Pulse Width Modulation) digital control technology for precise and accurate color management. The controller can ONLY be operated using the LED phone app. This app is available for both IOS and Android.

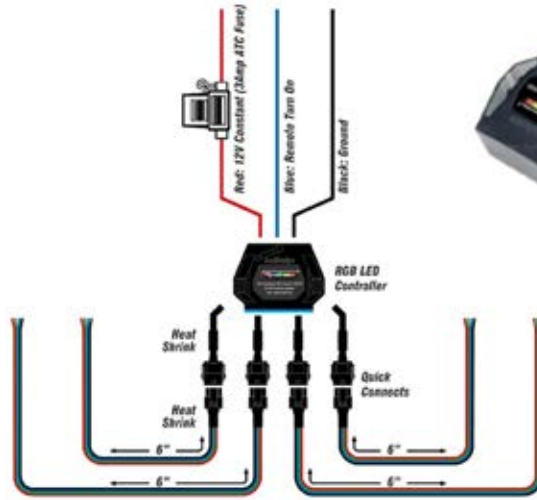

#### PIPEDREAM LED APP



### NL-412BT

#### WHEEL-WELL LED KIT CONTROLLER

- One RGB LED APP Controller with 4 Outputs with Connectors and Remote in Turn on Wire
- 4 x 4 RGB LED Module Lights
- 4 x 48" Male to Female Extension Cable
- Voltage: 12V DC, Current: 10A



Works with APP (IOS & Android)



IP67 Waterproof



3M Adhesive



RGB



#### PIPEDREAM LED APP



### NL-ADPT-2A12

#### POWER ADAPTER

- Compatible with all 12V LED's
- Input: 100-240VAC
- Output: DC 12V
- 2000mA Max



AC 120V Input

DC 12V Output

2000mA Max

### NL-464-EXT

#### EXTENSION POWER WIRE

- Pack of 2
- Extension Power Wire for: NL-464-BTK Wireless Stream RGB LED Controller



13 ft

**Pipeman's**  
**Installation**<sup>®</sup>  
**Solution**

**2022 CATALOG**



**IS-SS7048-SIB**

**2-IN-1 SOLDERING STATION**

- Input voltage: 110V AC, 50Hz
- Output Power: 70W / 750W
- Heat Adjustment: 200-480°C / 100-480°C
- Temperature Stability: ± 1°C / ± 2°C
- Handle Operating voltage: 24V AC / 110V AC
- Nozzle to Ground Resistance: ≤ 2Ω
- Welding Nozzle to Ground Voltage: ≤ 2mV
- Air Flow: 120 L/min

This 2-IN-1 rework and soldering station is designed with dual digital LED displays for reliable accuracy. Easily adjust temperature with the touch of a button. It's fail-detecting and auto-shutoff functions make it safe to use anywhere. You will enjoy the versatility and durability of this soldering station anywhere!



**Replacement Parts Sold Separately**

**IS-SS6045-SPT**

**REPLACEMENT SOLDER TIP**



**IS-SS7048-EL**

**REPLACEMENT HEATING ELEMENT FOR HOT AIR HANDLE**



**IS-SS7048-AH**

**REPLACEMENT HOT AIR HANDLE**



**IS-SS6045-SH**

**REPLACEMENT SOLDER HANDLE**



**IS-SS7048-FN**

**REPLACEMENT FAN FOR HOT AIR HANDLE**



**IS-SS7048-SH**

**REPLACEMENT SOLDER HANDLE**



**IS-SS6045-SI**

**SOLDERING REWORK STATION**

- Supply voltage: 110V AC, 50Hz
- Output voltage: 24V AC
- Power: 60 Watts
- Grounding resistance of the soldernig tip:  $\leq 2\Omega$
- Voltage to the ground of the welding nozzle:  $\leq 2mV$
- Heating element: SP31208602 long life metal heating core
- Temperature error:  $\pm 3\text{ }^{\circ}\text{C}$  (static air:  $25\text{ }^{\circ}\text{C}$  45%)
- Temperature range:  $180\text{ }^{\circ}\text{C} \sim 450\text{ }^{\circ}\text{C}$
- Dimensions (W x H x D): 4.53" x 3.54" x 5.51"
- Weight: 1.3KG/2.87Lbs (Excluding the handle)



**IS-SS6045-SPT**

**REPLACEMENT SOLDER TIP**



**IS-SS6045-SH**

**REPLACEMENT SOLDER HANDLE**



**IS-SS6045-MSPT**

**REPLACEMENT SOLDER TIP**



**KTB-30**

**SOLDERING IRON**

- 30 Watts / 110V
- With Red Handle
- Slim Design



**76D12-40W**

**40 WATTS 12V PORTABLE SOLDER IRON**

- Ultra-Slim Textured Handle for Added Grip and Comfort
- 12V / 40 Watts

A versatile controlled tool for field servicing. Operates from 12 volt batteries or low voltage power source. Soldering iron comes complete with battery clips and 12 Feet fused cord.



**P-654**

Replacement tip available separately

**76B40W-LED**

**40 WATTS PENCIL SOLDERING IRON WITH LED ILLUMINATION**

- 40 Watts
- 110V
- 3 LED Lights / Application Illumination
- Superior Tip Positioning & Control
- Up to 400° C

**3 LEDs for superior accuracy and application illumination**



**76B60W-ADJ**

**60 WATTS ADJUSTABLE TEMPERATURE SOLDERING IRON**

- 60 Watts
- 110V
- Temperature: 200-480°
- Stainless Steel Tube
- Copper Welding Head



**Easily adjust up to five Different Temperatures**



**P-796**  
Replacement tip available separately

**74B70-60W**

**60 WATTS PENCIL SOLDERING IRON**

- 110V
- 60 Watts
- Works well on radio controls, small electrical parts, hobbies and crafts
- 4M Diameter



**C2-1**  
Replacement tip available separately

**71B30KT**

**30 WATTS PENCIL SOLDERING IRON KIT**

- For Welding a Wide Variety of Materials
- AC Operated
- 30 Watts / 110V
- For Electronics and Electrical Applications
- Base Includes Security for the Metallic End
- Included Accessories:
  - 1 Slotted Screwdriver
  - 1 Spare Tip
  - Welding Compound
  - Welding Grease



**74B30**

**30 WATTS PENCIL SOLDERING IRON**

- 30 Watts / 110V
- 4mm Diameter
- Slim Design
- Works well on radio controls, small electrical parts, hobbies and crafts



78B40 (40 Watts)

78B60 (60 Watts)

78B80 (80 Watts)

PENCIL SOLDERING IRON

- 110V
- CE approved



**KD-KTB-3040  
KD-KTB-60**  
Replacement tip  
available separately

**POPULAR**



79B65-30W (30 Watts)

79B65-40W (40 Watts)

79B65-60W (60 Watts)

PENCIL SOLDERING IRON

- 110V
- Slim ergonomic design
- Works well on radio controls, small electrical parts, hobbies and crafts



**P-654 & P-656**  
Replacement tip  
available separately

**POPULAR**



Simple and reliable soldering iron  
with durable long lasting tip

KTB-30W (30 Watts)

KTB-60W (60 Watts)

PENCIL SOLDERING IRON

- 110V
- Works well on radio controls, small electrical parts, hobbies and crafts



**KD-KTD-3040  
KD-KTB-60**  
Replacement tip  
available separately

**POPULAR**



74B55

30 WATTS PENCIL  
SOLDERING IRON

- 30 Watts / 110V
- 4mm Diameter
- For Electronics and Electrical Applications



**KD-55**  
Replacement tip  
available separately



74B70

40 WATTS PENCIL  
SOLDERING IRON

- 40 Watts / 110V
- 4mm Diameter
- Works well on radio controls, small electrical parts, hobbies and crafts



**KD-70**  
Replacement tip  
available separately





**77B20-150W**

**150 WATTS COPPER CHISEL TIP SOLDERING IRON**

- 150 Watts
- 110V
- Lightweight and heat resistance wood handle provides comfortable grip for soldering work.
- Long Lasting Simple Replaceable Bent Copper Tip
- Works for Household Electrical Appliances
- This 150W Soldering Iron is Ideal for Soldering Copper and Steel



**Ideal for soldering  
Copper and Steel**

**79B20-200W**

**200 WATTS HEAVY DUTY CHISEL TIP SOLDERING IRON**

- 110V
- 200 Watts
- Works for House Appliances
- Heavy-Duty
- ABS Handle



**77B20-30W (30 Watts)**

**77B20-40W (40 Watts)**

**77B20-60W (60 Watts)**

**200 WATTS HEAVY DUTY CHISEL TIP SOLDERING IRON**

- 110V
- Slim Design
- Lightweight and heat resistance wood handle provides comfortable grip for soldering work.
- Works well on radio controls, small electrical parts, hobbies and crafts



**Now Available in  
60W**

**79B21-30W**

**30 WATTS HEAVY DUTY  
SOLDERING IRON**

- 110V
- 30 Watts
- Works well on radio controls, small electrical parts, hobbies and crafts



**P-791  
Replacement tip  
available separately**

**77B20-100W**

**100 WATTS HEAVY DUTY  
SOLDERING IRON**

- 110V
- 100 Watts
- Industrial Soldering Iron Pen
- Lightweight and heat resistance wood handle provides comfortable grip for soldering work.



**P-720  
Replacement tip  
available separately**



**74B23**

**100 WATTS HEAVY DUTY SOLDERING GUN**

- Uses the "Closed Loop" Method of Controlling Maximum Tip Temperature
- Portable Line Voltage Iron - No Base Station Required
- Stainless Steel Modular Plug-In Heater, Greater Efficiency & Versatility
- Temperature is Controlled by Tip (600° F, 700° F & 800° F Tips)
- Nominal Heat-Up Time with 700° F Tip is 110 Seconds
- Designed to help to get your job done right
- Manufactured utilizing the highest quality materials
- Built to provide exceptional levels of durability



**KD-33**  
Replacement tip  
available separately

**79B100SS**

**100 WATTS SOLDERING IRON STATION**

- Adjustable Soldering Iron Station 110 Watts - 120V
- Variable Temperature Control 100°C-450°C
- Sturdy Compact Design
- On-Off Switch with Power-On Indicator Light
- Safety Guard Iron Holder



**KD-100SS**  
Replacement tip  
available separately

**KD-55**

**REPLACEMENT SOLDERING TIP**

- Replacement tip for 74B55 Soldering Iron



**KD-70**

**REPLACEMENT SOLDERING TIP**

- Replacement tip for 74B70 Soldering Iron



**KD-KTB-60**

**REPLACEMENT SOLDERING TIP**

- Replacement tip for KTB-60 Soldering Iron



**KD-KTB-3040**

**REPLACEMENT SOLDERING TIP**

- Replacement tip for KTB-30W and KTB-40W Soldering Iron



**KD-KTB-60**

**REPLACEMENT SOLDERING TIP**

- Replacement tip for KTB-60 Soldering Iron



**P-796**

**REPLACEMENT SOLDERING TIP**

- Dimensions: 0.25" L x 0.25" W x 1.75" H
- Handles temperatures between 200~480C



**P-656**

**REPLACEMENT SOLDERING TIP**

- Replacement tip for 79865-60W Soldering Iron
- 68mm



**P-1**

**REPLACEMENT SOLDERING TIP**

- Replacement tip for 74830 Soldering Iron



**P-720**

**REPLACEMENT SOLDERING TIP**

- Replacement tip for 77820 Soldering Iron



**P-791**

**REPLACEMENT SOLDERING TIP**

- Replacement tip for 79821-30W Soldering Iron
- 2"
- 5 PCS per unit



**KD-100SS**

**REPLACEMENT SOLDERING TIP**

- Replacement tip for 798100SS, 74870-30W, and 74870-40W Soldering Irons
- 2.5"



**P-654**

**REPLACEMENT SOLDERING TIP**

- Replacement tip for 79865-30W and 79865-40W Soldering Irons
- 66mm



**KD-85**

**REPLACEMENT SOLDERING TIP**

- Replacement tip for NBW-85



**KD-200**

**REPLACEMENT SOLDERING TIP**

- Replacement tip for NBW-200



**KD-33**

**REPLACEMENT SOLDERING TIP**

- Replacement tip for 74823 Soldering Iron



**KD-40**

**REPLACEMENT SOLDERING TIP**

- Replacement tip for NBW74



**HH-2**

**SOLDERING STAND**

- Acid-Free
- Non-Toxic Cellulose Tip Cleaning Sponge

This light weight, sturdy soldering stand safely keeps your soldering iron handy and accessible. The soldering iron stand includes a heat shield that provides an extra layer protection. It includes soldering iron tip-cleaning sponge and assembly hardware.

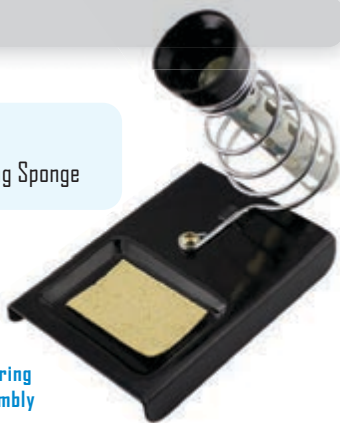

**HH-4DS**

**SOLDERING STAND & HOLDER WITH SOLDER FEEDER**

- Soldering Iron Stand and Holder
- With Solder Feeder and Sponge
- Safety Outer Metal Holder
- Holds up to 2 lb. Roll of Soldering Wire
- Tip Cleaning Special Sponge

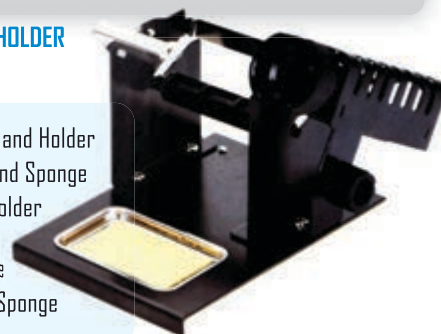

**HH-3MG**

**THIRD HAND TOOL WITH SOLDER STAND**

- Adjustable joints for versatile movement in all directions
- Strong "Alligator clamps" hold work securely
- Heavy cast-iron base for added stability
- Distortion-free magnifying glass

Designed with the hobbyist, electrician, jeweler, and everyday user in mind. This helping hand is perfect for soldering, detailed work, and working with small parts.



**HH-1**

**DUAL HELPING HANDS**

- Holds Work in any Position Leaving Hands-Free for Soldering

Six ball joints permit movement to the exact angle required for hands-free operation. Tightened (Locked in Place) by thumb screw. Alligator clips, adjustable to any position, hold small shapes securely. heavy base prevents tipping.



**HH-TWEZ-6**

**6 PIECE ANTI-STATIC ESD TWEEZERS SET KIT**

- Resistive ESD coating helps protect electronics from static damage
- Durable stainless steel material: Only the tweezer's tips are non-magnetic
- These tweezers can be widely applied to PCB, repairing of watches, crafts, jewelry, electronics, laboratory work and so on
- Each tweezer comes with a protective plastic tip cover for safe handling
- Includes 1 pair of flat head tweezers, 1 pair of curved tips tweezers and 4 pairs of pointy tip tweezers



**GAS-WRSTS**

**6 PIECE ANTI-STATIC ESD TWEEZERS SET KIT**

- Anti-Static Wrist Strap
- Current Limiting Resistor  $1M\Omega \pm 5\%$
- Electro-Scattering Time: 0.1 Sec
- Adjustable Grounding
- Suitable for Use in Electronic Repair Shops



**W-1**

**SFT DESOLDERING WIRE**

- 2.5mm Width
- 1.5M Length



**SP-10 (10 Grams)**

**SP-50 (50 Grams)**

**SOLDER PASTE**

- In plastic case



**SP-15 (15 Grams)**

**SOLDER PASTE**

- In plastic case



**60-40 1/2LB**

**ROSIN CORE SOLDER WIRE**

- 60% Rosin/ 40% Lead
- 1/2 LB Spool
- 0.8mm Diameter



**40-60 1LB (40% ROSIN/60% LEAD)**

**60-40 1LB (60% ROSIN/40% LEAD)**

**ROSIN CORE SOLDER WIRE**

- 1 LB Spool
- 0.8mm Diameter



**40-60 PEN (40% ROSIN/60% LEAD)**

**60-40 PEN (60% ROSIN/40% LEAD)**

**ROSIN CORE SOLDER WIRE**

- Pen Type
- 0.8mm Diameter
- 9.8 ft Length



**MADE IN TAIWAN**

**MADE IN TAIWAN**

**60-40 1.0MM**

**ROSIN CORE SOLDER WIRE**

- 60% Rosin Core
- 40% Lead Diameter: 1.0mm
- Net Weight: 1 lb



**60-40-12 (60% ROSIN/40% LEAD)**

**ROSIN CORE SOLDER WIRE**

- Rosin Core Solder Wire
- 1 lb. Spool
- 0 1.2 mm



**NBW-74**

**DESOLDERING SUCKER TOOL**

- Metal Desoldering Pump
- 7.5"
- Changeable Teflon Tip
- Durable Aluminum Housing



**KD-40**  
Replacement  
tip available  
separately

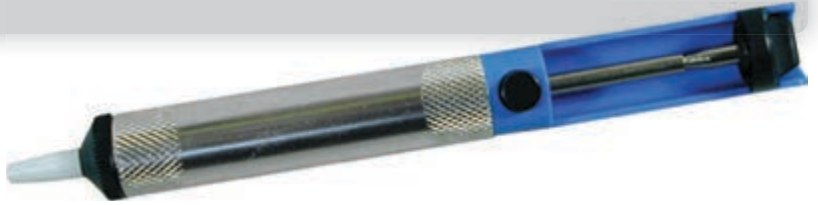

Powerful suction for solder removal. Spring loaded piston design to quickly and effectively remove solder from a circuit board.

**NBW-50**

**DESOLDERING SUCKER TOOL**

- Plastic Desoldering Pump
- 7.5"
- Changeable Teflon Tip



**KD-50**  
Replacement  
tip available  
separately



**NBW-85**

**LARGE DESOLDERING SUCKER TOOL**

- Large Plastic Desoldering Pump
- 8"
- Changeable Teflon Tip



**KD-85**  
Replacement  
tip available  
separately

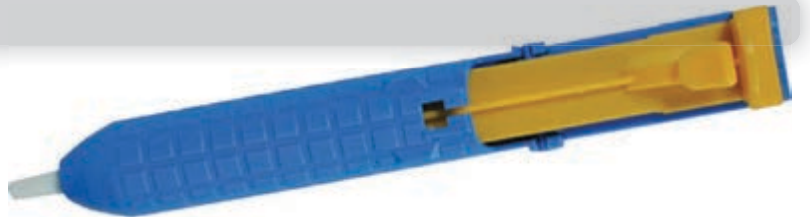

**NBW-100**

**LARGE DESOLDERING SUCKER TOOL**

- Large Plastic Desoldering Pump
- 10"
- Changeable Teflon Tip



**KD-100**  
Replacement  
tip available  
separately



**NBW-200**

**EXTRA LARGE DESOLDERING  
SUCKER TOOL**

- Large Plastic Desoldering Pump
- 13"
- Changeable Teflon Tip
- Anti-skid design makes it easy to hold and use.
- Quality material, high heat-resisting suction nozzle



**KD-200**  
Replacement  
tip available  
separately



Large, lightweight antistatic desoldering vacuum pump, with replaceable teflon tip and anti-corrosive spring. Ideal for removing solder from printed circuit boards. The combination of light weight, limited recoil and large extraction volume make this a great desoldering tool.

**HHML-6085-3D**

**60 SMD LED MAGNIFYING LAMP**

Replacement parts sold separately.  
**BIFOCALS** - This Magnifying Lamp comes with bifocals 5" diameter lens with two parts with different focal lengths, the large lens for distant vision (5 diopter) and the small lens for near vision (20 diopter)

- **720 LUMENS BRIGHT** - Super LED light provides 720 lumens for reading small print or working on your special projects. Our large 5-diopter (225%) lens and small 20-diopter (600%) produce a bright beam of vivid light without glare. This energy-saving desk lamp will last up to 100,000 hours and is great for reading, knitting, circuit boards, and soldering. And the best part is it doesn't get hot!
- **DIMMABLE** - Simply press the power button to adjust the brightness level by 25%, 50%, 75%, or 100%. This feature is a must-have if you are looking for the perfect lighting for various tasks and is a highly desired feature of many of our customers.
- **MULTI-PURPOSE LED** - You can either use this as an LED desk lamp or magnifying lamp by opening or closing the lens cover with the easily adjustable triple-joint arm.
- **Voltage:** AC 110-120V, 60Hz



Premium 2-in-1 lighting and magnification lamp with metal G-clamp for desktop use. Comes with 5" round glass lens and a hinged, dust-proof cover. Uses 80 Ultra-efficient SMD LEDs which offer glare-free light. Adjustable swing arm is made of metal and includes an arm cover which reduces possibility of hand pinching or injury. 2 Prong ungrounded plug. Lens cleaning cloth included.



**DIGITAL MULTIMETERS**

**IS-9699-NCVHAR**

**19999 COUNTS LCD DISPLAY  
DIGITAL MULTIMETER**

**General Specifications**

- Display (LCD): 19999 counts
- Ranging: Auto/Manual
- Material: ABS
- Update Rate: 3 times/second
- Low Battery Indication
- True RMS
- Data Hold
- Backlight
- Relative Measurement
- MAX/MIN
- Auto Power Off

**Mechanical Specifications**

- Dimensions: 6.3" x 3.2" x 1.5"
- Weight: 0.44 Lbs
- Battery Type: 1.5V AA Battery x 2 (Included)

**Environmental Specifications**

- Operating Temperature: 0~40°C
- Operating Humidity: <75%
- Storage Temperature: -20~60°C
- Storage Humidity: <80%



**Accessories Included**



**IS-9609-SQWRMS**

**9999 COUNTS LCD DISPLAY  
DIGITAL MULTIMETER**

**General Specifications**

- Display (LCD): 9999 counts
- Ranging: Auto
- Material: ABS
- Update Rate: 3 times/second
- Low Battery Indication
- True RMS
- Data Hold
- Backlight
- Auto Power Off

**Mechanical Specifications**

- Dimensions: 5.1" x 2.6" x 1.3"
- Weight: 0.25 Lbs
- Battery Type: 1.5V AAA Battery x 2 (Included)

**Environmental Specifications**

- Operating Temperature: 0~40°C
- Operating Humidity: <75%
- Storage Temperature: -20~60°C
- Storage Humidity: <80%



**Accessories Included**

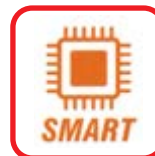



**IS-9606-TEMLM**

**6000 COUNTS LCD DISPLAY  
DIGITAL MULTIMETER**

**General Specifications**

- Display (LCD): 6000 counts
- Ranging: Auto
- Material: ABS
- Update Rate: 3 times/second
- Low Battery Indication
- True RMS
- Data Hold
- Backlight
- Auto Power Off

**Mechanical Specifications**

- Dimensions: 5.1" x 2.6" x 1.3"
- Weight: 0.25 Lbs
- Battery Type: 1.5V AAA Battery x 2 (Included)

**Environmental Specifications**

- Operating Temperature: 0~40°C
- Operating Humidity: <75%
- Storage Temperature: -20~60°C
- Storage Humidity: <80%



**Accessories Included**



**IS-9604-NVECO**

**4000 COUNTS LCD DISPLAY  
DIGITAL MULTIMETER**

**General Specifications**

- Display (LCD): 4000 counts
- Ranging: Auto
- Material: ABS
- Update Rate: 3 times/second
- Low Battery Indication
- True RMS
- Data Hold
- Backlight
- Flashlight
- Auto Power Off

**Mechanical Specifications**

- Dimensions: 4.7" x 2.4" x 1.1"
- Weight: 0.26 Lbs
- Battery Type: 1.5V AAA Battery x 2 (Included)

**Environmental Specifications**

- Operating Temperature: 0~40°C
- Operating Humidity: <75%
- Storage Temperature: -20~60°C
- Storage Humidity: <80%



**Accessories Included**



**IS-9604-CMPSMT**

**AC 600A CLAMP METER**

**General Specifications**

- Display (LCD): 4000 counts
- Ranging: Auto
- Material: ABS
- Update Rate: 3 times/second
- Low Battery Indication
- True RMS
- Data Hold
- Low Battery Indication
- Auto Power Off

**Mechanical Specifications**

- Dimensions: 6.8" x 2.5" x 1.3"
- Weight: 0.35 Lbs
- Battery Type: 1.5V AAA Battery x 2 (Included)

**Environmental Specifications**

- Operating Temperature: 0~40°C
- Operating Humidity: <75%
- Storage Temperature: -20~60°C
- Storage Humidity: <80%



**Accessories Included**

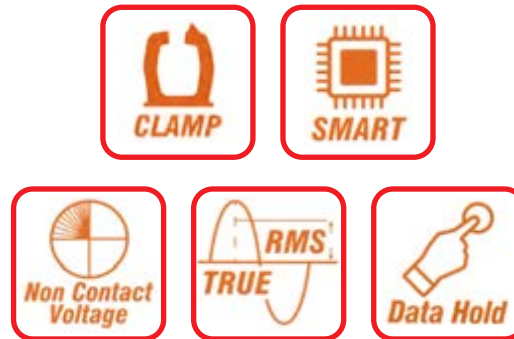

**IS-500-ANGPLM**

**ANALOG MULTIMETER**

- Voltage DC: 10/50/250/500V
- Voltage AC: 10/50/250/500V
- Current DC: 10m/100m/250m/500m
- Current AC: 10m/100m/250m/500m
- DC: 10A
- Battery: 1.5V (AAA); 9V, 1.5V (button cell)
- Resistance: Rx10 / Rx100 / Rx1kΩ
- Continuity: Yes
- Operating Temperature: 0~50°C, <85% RH
- Storage Temperature: -5~50°C, <85% RH
- Dimensions: 6.2" x 3.1" x 2.2"
- Weight: 0.64 lbs (including batteries)
- Fits in the palm of your hand
- Full measurement range protection
- Molded rubber casting

**HIGH PRECISION**



**IS-600-ANGTAB**

**ANALOG MULTIMETER**

- Voltage DC: 2.5/10/50/250/600V
- Sensitivity: 20kΩ/V
- Voltage AC: 10/50/250/500V
- Frequency Response: 60~400Hz
- Sensitivity: 9kΩ/V
- Current DC: 10mA/250mA/500mA/10A
- Current AC: 10mA/250mA/500mA/10A
- Frequency Response: 60~400Hz
- Resistance: Rx10/Rx1kΩ
- Continuity: <30Ω
- AC/DC: 10A
- Battery: 1.5V (AAA)
- Operating Temperature: 0~50°C, <85% RH
- Storage Temperature: -5~50°C, <85% RH
- Dimensions: 6.8" x 4.4" x 1.7"
- Weight: 0.77 lbs (including batteries)

**HIGH PRECISION**



**ST-385**

**STANDARD CAPACITOR MULTIMETER**

- DCV: 0-0.1-0.5-2.5-10-50-250-1000V
- ACV: 0-10-50-250-1000V
- DEC: -8 to +62dB
- Battery: 1.5V x 2, 9V x 1



**ST-4300CT**

**DIGITAL MULTIMETER AND CABLE TESTER**

- DCV: 200mV-1000mV ± (0.5%+1)
- ACV: 2V-750V ± (0.8%+3)
- DCA: 2mA-20A ± (1.0%+5)
- ACA: 200mA-20A ± (1.5%+5)
- OHM: 200W-20mW ± (0.8%+3)
- Continuity Buzzer
- Test for continuity: RJ11/RJ12/RJ45/USB
- Diode Test
- Transistor Test



**ST-4068CT**

**DIGITAL MULTIMETER AND CABLE TESTER**

- DCV: 200mV-500V ± (0.5% + 2)
- ACV: 200V-500V ± (1.2% + 10)
- DCA: 2000uA-10A ± (1% + 2)
- OHM: 200W-2mW ± (0.8% + 2)
- Continuity Buzzer
- Test for continuity: RJ-11/RJ-45
- Diode Test
- Data Hold for Easy Reading



**IS-HHM300**

**HANDHELD MULTIMETER**

- DCV: 2-500V± (0.5%+1)
- ACV: 2-500V± (1.2%+10)
- DCA: 0-200mA ± (2%+2)
- OHM: 2-2000 KΩ ± (1%+2)
- Continuity Beep
- Diode Test
- Power: 12V
- Dimensions: 2.8" x 4.7" x 0.7"
- Weight: Approx 0.24 lb (110 g included Battery)



**IS-HHM53L**

**DIGITAL MULTIMETER**

- DCV: 200mV-2-20-200-600V
- ACV: 200-600V
- DCA: 200µA-2mA-20-200mA-10A
- Resistance: 200Ω-2k-20k-200k-2MΩ
- Transistor Test
- Diode Test
- Data Hold for Easy Reading
- Does Not Include Battery



**IS-HHM95TF**

**DIGITAL MULTIMETER**

- DCV: 0-2-20-200-1000V (1MΩ) ± 0.5%
- ACV: 0-200m-2-20-200-750V (450KΩ) ± 1.2%
- DCA: 2m-20m-200m-20A
- ACA: 2m-20m-200m-20A
- Impedance: 10mΩ
- Temperature Test: -40°C - 1000°C
- Continuity Beep
- Indicated Over Range
- Does Not Include Battery

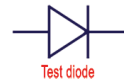

**ST-5077**

**DIGITAL MULTIMETER**

- DCV: 200m-1000V
- ACV: 200-750-1000V
- DCA: 200 $\mu$ A-10A
- OHM: 200-2000K Ohms
- Battery: 9V



**IS-HHM5708**

**DIGITAL AUTO RANGE MULTIMETER**

- DCV: 0-500V $\pm$  (1%+2)
- ACV: 0-500V $\pm$  (1%+3)
- DCA: 0-10A  $\pm$  (2%+3)
- ACA: 0-10A  $\pm$  (1.2%+3)
- OHM: 0-20M  $\Omega$   $\pm$  (2%+3)
- Continuity beep
- Auto range & power off
- Diode Test



**IS-9000-ECO**

**ECO DIGITAL MULTIMETER**

- Display (LCD): 4000 counts
- Ranging: auto
- Material: ABS
- Update rate: times/second
- Low battery indication
- True RMS
- Data hold
- Backlight
- Flashlight
- Auto power off

**4000 Counts  
Display (LCD)**



**IS-HHM75**

**DIGITAL MULTIMETER**

- DCV: 200mV-2-20-200-1000V
- ACV: 200mV-2-20-200-700V
- DCA: 20 $\mu$ -200 $\mu$ -200m-20A
- ACA: 2m-20m-20m-200m-2-10A
- Resistance: 200-2k-20k-200k-2M-200M $\Omega$
- Continuity Beep
- Auto Power OFF
- Automatic Over Range Indication
- Does Not Include Battery



**ST-5505**

**DIGITAL MULTIMETER**

- 6.2 x 3.3 cm LCD display
- Blue backlight
- Quick display; updated 2-3 reads per second
- Data hold function
- DC Voltage: 200 mV / 2000 mV / 20 V / 200 V / 1000 V  $\pm$ (0.5%)
- DC Current: 20 mA / 200 mA / 20 A  $\pm$ (1.8%)
- AC Voltage: 2 V / 20 V / 200 V / 750 V  $\pm$ (1.5%)
- AC Current: 200  $\mu$ A / 2 mA / 20 mA / 200 mA / 20 A  $\pm$ (1%)
- Resistance: 200  $\Omega$  / 2 K $\Omega$  / 20 K $\Omega$  / 200 K $\Omega$  / 2 M $\Omega$  / 200 M $\Omega$   $\pm$ (1%)
- Transistor test hFE: 20 nF / 200 nF / 2  $\mu$ F / 200  $\mu$ F  $\pm$ (1%)
- Diode test: Display shows the direct voltage of the diode
- Test continuity: A signal sounds if the conductance is less than 30  $\pm$  20  $\Omega$
- Battery test: 1.5 V / 9 V
- Pair of test leads included
- Dimensions : 6 x 22 cm
- Weight : 0.55kg



**IS-HHM26ACL**

**DIGITAL MULTIMETER WITH AC CLAMP METER**

**POPULAR**

- DCV: 0-1000V  $\pm$  (1%+1)
- ACV: 0-750V  $\pm$  (2%+3)
- DCA: 0-200A  $\pm$  (2%+3)
- ACA: 0-200A  $\pm$  (2.5%+3)
- OHM: 0-40m $\Omega$   $\pm$  (1.5%+2)
- Continuity Beep
- Frequency Test
- Capacitance Test
- Diode Test



**ST-7**

**MINI TYPE CAPACITOR MULTIMETER**

- DCV: 0-2.5-10-50-250-500V
- ACV: 0-10-50-250-500-1000V
- DEC: -10 to +25dB
- Battery: 1.5V



**ST-902**

**AC VOLTAGE TESTER**

- Sound and Light Instructions
- Adjustable Sensitivity
- Setting the Default Sensitivity
- Wireless AC Voltage Tester
- Designed to International Safety Standard: EN61010-1/ 600V CAT III
- Battery: AAA



**IS-ICTL-1224V**

**12/24V CIRCUIT TESTER**

- Ergonomic Grip Design with 6 Ft. Test Leads
- Bright White LED Illuminates Troubleshooting Area
- Transparent Handle Shows Bright LED's to Identify Connections
- Blue = Ground Present
- Red = Voltage Present
- Helps to Quickly Identify if there is Voltage Present on Wiring and Circuits



**ICT-112**

**HEAVY DUTY CIRCUIT TESTER**

- Checks 6, 12, & 24 Volt Circuits
- Supplied with 60" Cable



**POPULAR**



**ICT-115LED**

**LED CIRCUIT TESTER**

- Quickly checks all 6 & 12 Volts Systems
- Supplied with Long 47" /1.2M Cable
- Strong Alligator Lead Clip
- Test Short / Open Circuit
- With Red LED



**With RED LED**



**IS-9013**

**TESTING CONSOLE WITH HDMI PORT**

- I/S testing console
- CB antenna cable & indicator light
- Left and right speaker
- RJ-11 phone jack
- 12V power supply
- Speaker spring connectors
- RCA jacks
- Coax connectors

**Works well for:**

- Telephone, fax, and answering machines
- Video games
- Camcorders
- Televisions
- VCR's
- CB radios
- Car radios/stereos



**NT-TONEG**

**tone generator for testing speakers**

- This compact tone generator is great for general tests and troubleshooting of virtually any audio installation including automotive, residential and distributed commercial systems
- Line level audio output is high enough to drive home theatre, auto sound and pro sound inputs, and speaker level output delivers over 1W signal



**NT-PHASE**

**polarity/phase tester**

- This polarity/phase tester utilizes state of the art signal processing to accurately determine absolute polarity, which is unimpaired by passive crossovers or signal waveform distortions produced by the device under test
- It works with tweeters, midranges and woofers, subwoofer speakers and cabinets, plus equalizers, amplifiers and crossovers



**NB-409**

**test leads**

- Three foot cord with two pin prods on each end



**NB-413**

**test leads set**

- Three foot set includes 10 wires and 20 clips in black, green, red, white, and yellow



**NB-414**

**test leads**

- Three foot cord with two pin prods to banana plugs



**NB-425**

**test lead with protector**

- Four foot pin prods to right angle



**NB-341 BLK**

**NB-341 RED**

**clips**

- Alligator Clips



**NB-437**

**test leads**

- Flexible cable with right angle DMM plugs
- 0.08" (2mm) diameter contact tips
- Max Test Voltage: 600V/1 000V
- Max Test Current: 1 0A



**POPULAR**

**NB-2**

**battery snaps**

- 9-volt battery snaps with wire leads



**NB-416 RED**

**BANANA PLUG**

- Long handle





- NB-343 BLK (1")
- NB-343 RED (1")
- NB-344 BLK (1.5")
- NB-344 RED (1.5")
- NB-345 BLK (2")
- NB-345 RED (2")

**CLIPS**

- Alligator Clips



**ST-SB32-ABS**

**SOLDERLESS BREAD BOARD  
PROTOTYPE**

- Material: ABS
- 1 pc Terminal Strip, Tie-Point 300
- 2pcs Distribution Strips, 50pcs each
- Binding Post: None
- Board: 8.3 x 5.5cm
- Thickness: 0.85cm
- Metal Plate: None

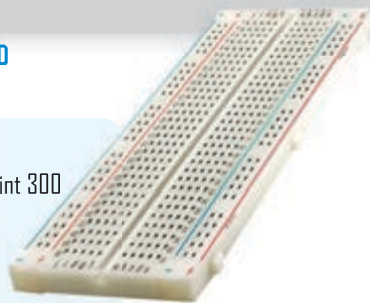

**Popular For  
Tech Students**

**ST-SB73-ABS**

**SOLDERLESS BREAD BOARD  
PROTOTYPE**

- Material: ABS
- 2pcs Terminal Strips, Tie-Point 1260
- 1 pc Distribution Strip, Tie-Point 100
- 2pcs Binding Posts
- Board: 16.6\*7.95cm(7X3")
- Thickness: 0.85cm
- Metal Plate: 21.3 x 10.5 x 0.12cm



**Popular For  
Tech Students**

**EPB-64**

**SOLDERLESS BREAD BOARD  
PROTOTYPE**

- Material: ABS

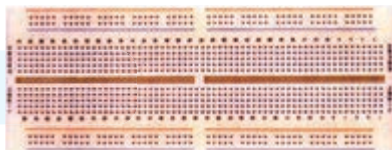

**Popular For  
Tech Students**

**ST-SB74-ABS**

**SOLDERLESS BREAD BOARD  
PROTOTYPE**

- Material: ABS
- 2pcs Terminal Strips, Tie-Point 1260
- 3pcs Distribution Strips, Tie-Point 300
- 3pc Binding Posts
- Size of Board: 16.6\*9.85 (7X4")
- Thickness: 0.85cm
- Metal Plate: 21.3\*13\*0.12cm



**Popular For  
Tech Students**

**ST-BB23-CPR**

**SOLDERABLE COPPER PCB BOARD**

- 504 points
- 0.042" hole diameter
- 0.1" spacing
- Copper clad
- Size: 2" wide x 3" long x 1/16" thick
- 5 pcs per unit

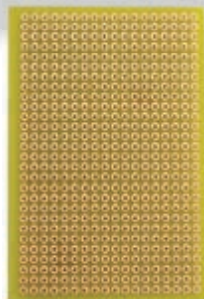

**Popular For Tech Students**

**ST-BB46-CPR**

**SOLDERABLE COPPER PCB BOARD**

- 2,204 points
- 0.042" hole diameter
- 0.1" spacing
- Copper clad
- Size: 4" wide x 6" long x 1/16" thick
- 5 pcs per unit

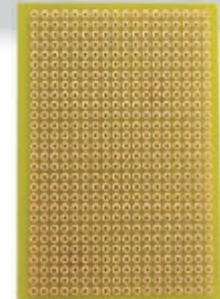

**Popular For Tech Students**

- |                           |                         |
|---------------------------|-------------------------|
| LED-5M-B4K-3BR (Bi-Color) | LED-5M-2H-3RED (Red)    |
| LED-5M-3H-3BLU (Blue)     | LED-5M-4H-3YLW (Yellow) |
| LED-5M-4K-3GRN (Green)    | LED-5M-14K-3WHT (White) |



**5MM LED LIGHT EMITTING DIODES BULB**

- 100 pcs per unit
- Head type: Round
- Max. Current: 20 mA
- Forward Voltage: R/ Y 2.0-2.2V; G/ W/ B 3.0-3.2V
- Bright and vivid: With high-quality Resin, our LEDs provide bright and beautiful lights with vivid colors. Each color of LEDs has 40 pcs
- For long term use: ROHS Standard, Silver Plating Corrosion-resistant Stands, high-quality lighting components. These LEDs should last much longer than you think
- Various usage: Perfect for light decorations, electronic devices, digital devices, traffic light indicators, lighting, car components and so on
- Durable design: Made of premium quality material with ISO Standard manufacturing process, these LEDs are super durable



**Popular For Tech Students**

**LED-5M-IR850**

**5MM INFRARED LED**

- 5 mm Clear Transparent Round Small Lens (Emitting Angle: 30 degrees)
- Forward Voltage / Direct Current : DC 1.2 Volt 20 mA (Low Voltage for DIY PCB Circuit)
- Infrared Ray 940nm (Invisible Light)
- Polarity (1.2 V) : Anode (Longer Part) | Cathode (Shorter Part)

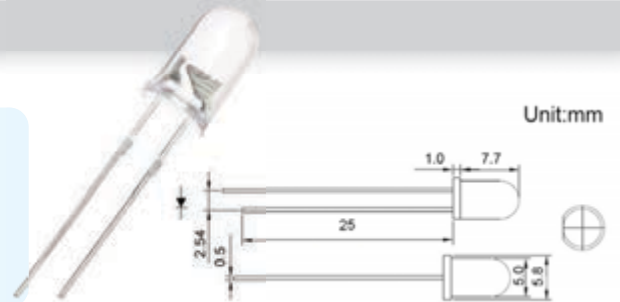

**ST-JW65MM**

**140 PCS 22AWG SOLID WIRES**

- Pre-Cut, Pre-Stripped and Pre-Formed on Each End
- Various Colors
- Completely Reusable
- 14 Length / 10 Pcs Each (2.5/5.1/7.7/10.3/12.7/15.3/17.8/20.1/22.8/25.4/51.3/76.3/101.3/126.3mm)



**Popular For Tech Students**

**MV-30V**

**DIGITAL VOLTMETER**

- Product Size: 48 x 29 x 21mm.
- Mounting Cutout: 45.5 x 26.5 mm.
- Voltage Test Range: 4.5 - 30V



**BUZ-324-85**

**ELECTRIC BUZZER WITH WIRE**

- Maximum input Voltage: 3-24VDC
- Operating Temperature Range: -20°C ~ +60°C
- Storage Temperature: -30°C ~ +70°C
- Sound Pressure Level: 82dB at 12VDC/30mm
- Resonant Frequency: 3.7 ± 0.5KHz
- Max Rated Current: 100mA at 12VDC
- Tone Nature: Continuous



**MVA-100V**

**VOLTAGE & AMP DUAL DISPLAY METER WITH CURRENT SHUNT**

- Size: 48mm x 29mm x 21mm
- Mounting Cutout: 45.5mm x 26.5mm
- Display Color: Red & Blue LED (Dual Display)
- Display: 0.28" LED Digital
- Operating Voltage: DC 4.5 ~ 30V
- Measure Voltage: DC 0 ~ 100V
- Minimum Resolution (V): 0.1V
- Refresh Rate: >500ms / times
- Measure Accuracy: 1% (± 1 Digit)
- Minimum Resolution (A): 0.01A
- Operating Current: <20mA
- Measure Current: 100A (with Current Shunt)
- Operating Temperature: -10 to 65°C
- Operating Humidity: 10 to 80% (Non-Condensing)



**MVT-230C**

**DIGITAL THERMOMETER (CELCIUS)**

- LCD Size: 1.4" x 0.6" (36x16mm)
- Power Source: 2 x LR44
- Cable Length: 3'/1M
- Meter Size: 1.9" x 1.1" x 0.6" (47.8 x 28.5 x 14.3mm)
- Mounting Cutout: 1.8" x 1.1" (46.2 x 26.7mm)
- Temperature Measurement Range: -5°C~110°C
- Operating Temperature: -5°C~50°C
- Extra Batteries Included



**MVT-230F**

**DIGITAL THERMOMETER (FAHRENHEIT)**

- LCD Size: 1.4" x 0.6" (36x16mm)
- Power Source: 2 x LR44
- Cable Length: 3'/1M
- Meter Size: 1.9" x 1.1" x 0.6" (47.8 x 28.5 x 14.3mm)
- Mounting Cutout: 1.8" x 1.1" (46.2 x 26.7mm)
- Temperature Measurement Range: -58°F~166°F
- Operating Temperature: 23°F~122°F
- Extra Batteries Included



**PIUB-3000-24X**

**3000 WATTS 24V DC TO 110V AC**  
**POWER INVERTER / BATTERY CHARGER**

- Power: 3000W Max, 1500W RMS
- DC input voltage: 24V
- Fuse: 25A x 4
- Output wave form: pure sine wave
- Output voltage: 110V ± 5%
- Output frequency: 60Hz ± 5%
- With DC input voltage protection, short circuit protection and temperature protection
- \* Backup times vary according to battery bank size and output consumption

**12V DC**  
**to**  
**110V AC**

**1200**  
**Watts**



The major advantage of a pure sine wave inverter is that all of the equipment which is sold on the market is designed for a pure sine wave. This guarantees that the equipment will work to its full specifications.

Works as a large capacity ups get up to 12 hours of backup for your electronic devices! doubles as a battery charger when plugged into a power outlet.

**PSW-3000C**

**3000 WATTS - 12V DC TO 120V AC  
PURE SINE WAVE POWER INVERTER**

- Max continuous power: 1500W
- Peak power: 3000W
- Input Voltage: 12V DC (10-15V)
- Output Voltage: 120V AC, 60Hz
- Waveform: Pure sine wave
- THD (Total Harmonic Distortion): Less than 4%
- USB Output: 5V DC, 2A Max
- Best efficiency: >85%
- Protection: Overload, Over Voltage, Low Voltage, Over temperature, Output short
- Output receptacle: Dual ETL Approval Sockets
- American standard receptacle
- Battery connecting cables: Red & Black 2ft length
- With ON/OFF wire remote control kit



Perfect for solar panels! Get Up to 12 hours of backup for your electronic devices. Doubles as a Battery charger when plugged into a power outlet.

**12V DC  
to  
120V AC  
3000 Watts**

**PSW-5000C**

**5000 WATTS - 12V DC TO 120V AC  
PURE SINE WAVE POWER INVERTER**

- Max continuous power: 2500W
- Peak power: 5000W
- Input Voltage: 12V DC (10-15V)
- Output Voltage: 120V AC, 60Hz
- Waveform: Pure sine wave
- THD (Total Harmonic Distortion): Less than 4%
- USB Output: 5V DC, 2A Max
- Best efficiency: >85%
- Protection: Overload, Over Voltage, Low Voltage, Over temperature, Output short
- Output receptacle: Dual ETL Approval Sockets
- American standard receptacle
- Battery connecting cables: Red & Black 2ft length
- With ON/OFF wire remote control kit



Perfect for solar panels! Get Up to 12 hours of backup for your electronic devices. Doubles as a battery charger when plugged into a power outlet.

**12V DC  
to  
120V AC  
5000 Watts**



The major advantage of a pure sine wave inverter is that all of the equipment which is sold on the market is designed for a pure sine wave. This guarantees that the equipment will work to its full specifications.



The major advantage of a pure sine wave inverter is that all of the equipment which is sold on the market is designed for a pure sine wave. This guarantees that the equipment will work to its full specifications.

**PIB-3000**

**300 WATTS 12V DC TO 115V AC  
POWER INVERTER**

- Input: 10.0~15.0V DC
- Power: 300W RMS, 600W Max
- Output: 110~120V AC
- Dual USB Output: 5V, 2A
- Output Frequency: 60Hz ± 2Hz
- Input Over Voltage Shutdown
- Input Under Voltage Warning
- Input Under Voltage Shutdown
- Input Fuse Protection
- Over Temperature Shutdown
- Output Short Circuit Protection
- Over Load Protection
- Digital Display



**12V DC  
to  
115V AC  
300 Watts**

**PIB-5000**

**500 WATTS 12V DC TO 115V AC  
POWER INVERTER**

- Input: 10.0~15.0V DC
- Power: 500W RMS, 1000W Max
- Output: 110~120V AC
- Dual USB Output: 5V, 2A
- Output Frequency: 60Hz ± 2Hz
- Input Over Voltage Shutdown
- Input Under Voltage Warning
- Input Under Voltage Shutdown
- Input Fuse Protection
- Over Temperature Shutdown
- Output Short Circuit Protection
- Over Load Protection
- Digital Display



**12V DC  
to  
115V AC  
500 Watts**

**POPULAR**

**PIB-7500**

**750 WATTS 12V DC TO 115V AC  
POWER INVERTER**

- Input: 10.0~15.0V DC
- Power: 750W RMS, 1500W Max
- Output: 110~120V AC
- Dual USB Output: 5V, 2A
- Output Frequency: 60Hz ± 2Hz
- Input Over Voltage Shutdown
- Input Under Voltage Warning
- Input Under Voltage Shutdown
- Input Fuse Protection
- Over Temperature Shutdown
- Output Short Circuit Protection
- Over Load Protection
- Digital Display



**750 Watts**

**PIB-10000**

**1000 WATTS 12V DC TO 115V AC  
POWER INVERTER**

- Input: 10.0~15.0V DC
- Power: 1000W RMS, 2000W Max
- Output: 110~120V AC
- Dual USB Output: 5V, 2A
- Output Frequency: 60Hz ± 2Hz
- Input Over Voltage Shutdown
- Input Under Voltage Warning
- Input Under Voltage Shutdown
- Input Fuse Protection
- Over Temperature Shutdown
- Output Short Circuit Protection
- Over Load Protection
- Digital Display



**12V DC  
to  
115V AC  
1000 Watts**

**THSY-E200R**

**750 WATTS 12V DC TO 115V AC POWER INVERTER**

- Input Voltage: 10 ~ 16V DC
- Input Current: 25A @ 13.6V
- Output Power: 200W (MAX)
- Standby Current Less Than 150mA
- Operating Temperature: -40° C ~ + 55° C
- Humidity Less Than 95%
- Siren Frequency: 420Hz ~ 1770Hz
- 10 Selectable Tones



**200 Watts Power**

**THSY-E200R-RM**

**REMOTE CONTROL**

- Remote Control for THSY-E200R



**PI-75U**

**75 WATTS - 12V DC TO 120V AC  
MOBILE POWER INVERTER**

- Provides a maximum 75W of power, 140W of peak power, and 60W of continuous power.
- Maximum power: The first 5 minutes of power. After 5 minutes, the inverter can only supply continuous power.
- Peak power: For electronic appliances that have a motor, a quick surge of power is required to start it.
- Continuous power: The power that the inverter can support for as long as the battery has capacity.
- Audible alarm warns of low battery voltage.
- Auto shutdown protects against overload, short-circuit, over temperature and low and high battery condition.

Converts 12V DC battery power to 120V AC household electrical power. For use in cars, trucks, boats, and RVs.

**USB  
Charger**



**PI-120U**

**120 WATTS - 12V DC TO 120V AC  
MOBILE POWER INVERTER**

- Fast charge USB2.0 (2.1A output) charge port for tablets and most mobile devices.
- Provides a maximum 120W of power, 200W of peak power, and 100W of continuous power.
- Maximum power: The first 5 minutes of power. After 5 minutes, the inverter can only supply continuous power.
- Peak power: For electronic appliances that have a motor, a quick surge of power is required to start it.
- Continuous power: The power that the inverter can support for as long as the battery has capacity.
- Auto shutdown protects against overload, short-circuit, over temperature and low and high battery condition.

Converts 12V DC battery power to 120V AC household electrical power. For use in cars, trucks, boats, and RVs.

**USB  
Charger**

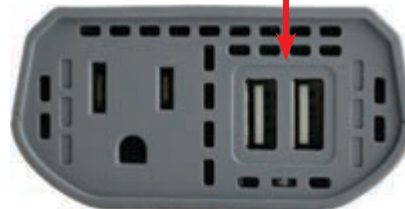

**PI-200A**

**200 WATTS - 12V DC TO 110V  
AC POWER INVERTER**

- Maximum Continuous Power: 200W
- Peak Load Power Rate: Up to 400W
- For Use with 12 Volt Systems
- No Load Current Draw: Up to 0.3 Amps
- Waveform: Modified Sine Wave
- Input DC Voltage Range: DC 11V-15V
- USB Output: 5V/2.4A
- Overload and Short-Circuit Protection
- (1) Replaceable External 20 Amp Fuse
- Built-In Cooling Fan
- (2) 110V AC 3 Prong Grounded Receptacles
- Overload Indicator
- 14 AWG 24" Cigarette Plug Cable
- Fin-type heat sink for more efficient heat dissipation

**12V DC  
to  
110V AC**  
**200 Watts**



**PI-400A**

**400 WATTS - 12V DC TO 110V  
AC POWER INVERTER**

- Max continuous power: 400W
- Peak load power rate: up to 800W
- For use with 12 Volt systems
- No load current draw: up to 0.5 Amps
- Waveform: modified sine wave
- Input DC voltage range: DC 10V-15V
- USB Output: 5V/2.4A
- Overload and short-circuit protection
- (1) Replaceable External 40 Amp fuse
- Built-in cooling fan
- (2) 110V AC 3 prong grounded receptacles
- Overload indicator
- 18 AWG 24" cigarette plug cable
- Fin-type heat sink for more efficient heat dissipation

**12V DC  
to  
110V AC**  
**400 Watts**



**PI-800C**

**800 WATTS - 12V DC TO 120V AC  
POWER INVERTER**

- Max Continuous Power: 800W
- Peak Load Power Rate: up to 1600W
- For Use with 12V DC Voltage Systems
- No Load Current Draw: up to 0.9 Amps
- Waveform: Modified Sine Wave
- Input DC Voltage Range: 10V-15V DC
- USB Output: 5V/2.4A
- Overload and Short-Circuit Protection
- (1) Replaceable 30 Amp Fuse
- Built-In Cooling Fan
- (2) 120V AC Volt 3 Prong Grounded American Standard Receptacles
- Overload Indicator



**12V DC to 120V AC**  
**800 Watts**

**PI-1000R**

**1000 WATTS - 12V DC TO 120V AC  
POWER INVERTER**

- Continuous Power: 1000W
- Peak Load Power Rate: up to 2000W
- For use with 12V DC Voltage Systems
- No Load Current Draw: up to 0.9 Amps
- Waveform: Modified Sine Wave
- Input DC Voltage Range: 10V-15V DC
- USB Output: 5V/2.4A
- Overload and Short-Circuit Protection
- (1) Built-in 6 x 30 Amp Fuses
- Built-In Cooling Fan
- (2) 120V AC Volt 3 Prong Grounded American Standard Receptacles
- Overload Indicator



**12V DC to 120V AC**  
**1000 Watts**



**PI-1500R**

**1500 WATTS - 12V DC TO 120V AC  
POWER INVERTER**

- Nominal Input Voltage: 12.8-13.2V DC
- Nominal Output Voltage: 115±10%V AC
- Output Frequency: 60±3 Hz
- Operating Input Voltage: 10-15V DC
- Continuous Output Power: Up to 1500W
- Surge Output Power: 3000W
- Waveform: Modified Sine Wave
- Typical No Load Current: 0.5A DC
- Efficiency (Typical): 85%
- Input Overvoltage Shutdown: 15.5±0.5V DC
- Input Undervoltage Alarm: 10.5±0.5V DC
- Input Low Voltage Shutdown: 10.0±0.5V DC
- Output Power Overload Shutdown Level: 1800±300W
- Input Fuse: 6 x 30A
- USB Port: Two, 5V/2A



**12V DC to 120V AC  
1500 Watts**

**PI-DP-3000C**

**3000 WATTS - 12V DC TO 110V AC  
POWER INVERTER**

- Continuous Power: 1500W
- Peak Load Power Rate: up to 3000W
- Equivalent to standard household power
- Delivers high quality, clean power for superior performance
- Easy motor start-ups
- Reduced noise
- Reduced stress on circuitry
- Cost-effective
- High efficiency
- Light and portable
- Strong capability with most devices
- Not compatible with induction load devices such as medical equipment



**12V DC to 120V AC  
3000 Watts**

Converts 12V DC battery power to 110V AC household electrical power. For use in cars, trucks, boats, and RVs.



**PI-24110-400C**

**400 WATTS - 24V DC TO 110V AC POWER INVERTER**

- Max continuous power: 400W
- Peak load power rate: up to 800W
- For use with 24V DC voltage systems
- No load current draw: up to 0.2 Amps
- Waveform: modified sine wave
- Input DC voltage range: 20V - 30V DC
- USB Output: 5V/2.4A
- Overload and short-circuit protection
- (1) Replaceable 20 Amp fuse
- Built-in cooling fan
- (2) 120V AC Volt 3 prong grounded American standard receptacles
- Overload indicator



**24V DC to 110V AC  
400 Watts**

**PI-24110-800C**

**800 WATTS - 24V DC TO 110V AC POWER INVERTER**

- Max continuous power: 800W
- Peak load power rate: up to 1600W
- For use with 24V DC voltage systems
- No load current draw: up to 0.4 Amps
- Waveform: modified sine wave
- Input DC voltage range: 20V - 30V DC
- USB Output: 5V/2.4A
- Overload and short-circuit protection
- (1) Replaceable 20 Amp fuse
- Built-in cooling fan
- (2) 120V AC Volt 3 prong grounded American standard receptacles
- Overload indicator



**24V DC to 110V AC  
800 Watts**

**PI-24110-2000C**

**2000 WATTS - 24V DC TO 110V AC POWER INVERTER**

- DC 24V to AC 110V
- Frequency: 60Hz ± 5%
- Output Waveform: Modified sine wave
- Low Battery Voltage Alarm: 21 ± 1V
- Continuous Power: 2000W
- Surge Capability: 4000W
- Output Voltage: 110V
- Input Voltage: 24V DC
- Efficiency: >90%
- Static current: <1mA
- Output overloading protection: 2400W



**24V DC to 110V AC  
2000 Watts**

**PI-DCDC-2412-10**

**10A - 24V DC TO 12V DC CONVERTER**

- Output Power: 10Amp (Continuous) 15 Amp Max
- Standby Current: <0.02A
- Input Voltage: DC 20V~30V
- Output Voltage: DC 12V~13.8V
- Efficiency: >90%
- Cooling: By Air Convection
- Fuse: 10A x IPC
- Dimensions (LxWxH): 110x87x42mm
- Net Weight: 0.45Kg

**24V DC to 12V DC**  
**10 AMP**

**MOST  
DEPENDABLE  
FOR CIRCUIT  
PROTECTION**



**PI-DCDC-2412-30**

**30A - 24V DC TO 12V DC CONVERTER**

- Output Power: 30Amp (Continuous) 45 Amp Max
- Standby Current: <0.08A
- Input Voltage: DC 20V~30V
- Output Voltage: DC 12V~13.8V
- Efficiency: 85~90%
- Over Load: Circuit Protection
- Input Fuse: 30A
- Dimensions (LxWxH): 222x115x62mm
- Net Weight: 0.95Kg

**24V DC to 12V DC**  
**30 AMP**

**MOST  
DEPENDABLE  
FOR CIRCUIT  
PROTECTION**



**PI-DCDC-2412-100**

**100A - 24V DC TO 12V DC CONVERTER**

- Output Power: 100 Amp (Continuous), 130 Amp Max
- Standby Current: ≤1.0A
- Input Voltage: DC 20V~30V
- Output Voltage: DC 12V~13.8V
- Efficiency: 85~90%
- Thermal Protection: 65°C +/- 5°C
- Input Polarity Reverse: Diode Protection
- Output Polarity Reverse: Circuit Protection
- Output Short: Circuit Protection
- Over Heating: Circuit Protection
- Over Load: Circuit Protection
- Input Fuse: 4x30A
- Dimensions (L x W x H): 365x165x79mm
- Net Weight: 3.03Kg

**24V DC to 12V DC**  
**100 AMP**

**MOST  
DEPENDABLE  
FOR CIRCUIT  
PROTECTION**



**DC12-2405**

**5A - 24V DC TO 12V DC  
VOLTAGE CONVERTER**

- Input Voltage: DC 24V
- Output Voltage: DC 12V
- Maximum Current: 5A
- Fuse: 5A



**5 AMP**



Industry grade DC24v to 12v step down converter. Widely used for automotive, Bus, and truck applications. Safely Integrates car audio products, security systems, LED video monitors, telecommunications and other 12v after market products.

**DC12-2415**

**15A - 24V DC TO 12V DC  
VOLTAGE CONVERTER**

- Input Voltage: DC 24V
- Output Voltage: DC 12V
- Maximum Current: 15A
- Fuse: 15A



**24V DC to 12V DC  
15 AMP**



**DC12-2430**

**15A - 24V DC TO 12V DC  
VOLTAGE CONVERTER**

- Input Voltage: DC 24V
- Output Voltage: DC 12V
- Maximum Current: 30A
- Fuse: 30A



**24V DC to 12V DC  
30 AMP**



**FT230**

**900 WATT HIGH PERFORMANCE AGM BATTERY**

- Weight: 15.43 lbs
- Dimensions: 7.13 x 3.03 x 6.57 in
- Weight: 7.0 kg
- Dimensions: 181 x 77 x 167 mm
- Group Size: BT198L-BS
- Voltage: 12-Volt
- Terminal Type: M6
- CCA 230
- CA or MCA 310
- HCA 410
- PHCA 680
- Capacity @ 20hr Rate 20 AH
- Reserve Capacity @ 25 Amps 28 minutes
- Reserve Capacity @ 75 Amps -
- Watts 700
- Internal Resistance 7.0 mΩ



**FT2300**

**600 WATT HIGH PERFORMANCE AGM BATTERY**

- Weight: 13.89 lbs
- Dimensions: 7.13 x 3.03 x 6.57in
- Group Size: BT19BL-BS
- Voltage: 12 Volt
- Terminal Type: M6
- CCA: 180
- CA or MCA: 240
- HCA: 290
- PHCA: 500
- Capacity: @ 20hr Rate: 22
- Reserve Capacity @ 25 Amps: 22
- Watts: 600
- Internal Resistance: 17.0mΩ



CYCLING CAPACITY		RESERVE CAPACITY	
20 Hour Rate	<b>22 Amp Hours</b>	Reserve @25 AMPS	<b>28 Minutes</b>
		Reserve @75 AMPS	<b>5.5 Minutes</b>
ELECTRICAL SPECIFICATIONS		MECHANICAL SPECIFICATIONS	
Nominal Voltage	<b>12 Volt</b>	Group Size	-
C100	<b>24 AH</b>	Terminal Type	<b>M6</b>
C20	<b>22 AH</b>	Terminal Torque	See reverse side
CS	<b>18.7 AH</b>	Height (w/ terminal)	<b>6.57"</b> 167 mm
Short Circuit Current	<b>627 Amps</b>	Height (case only)	<b>6.57"</b> 167 mm
CCA	<b>210 Amps</b>	Width	<b>3.03"</b> 77 mm
CA or MCA	<b>275 Amps</b>	Length	<b>7.13"</b> 181 mm
PHCA	<b>550 Amps</b>	Weight	<b>13.31 lbs</b> 6.05 kg
Internal Resistance	<b>11 mΩ</b>	Case Type	<b>ABS Plastic - Flame Res. Rating UL94-HB</b>

**600 WATTS**

**ODYSSEY**  
**BATTERY**  
CROSS-REFERENCE  
**PC680**



**FT410**

**900 WATT HIGH PERFORMANCE AGM BATTERY**

- Weight: 23.15 lbs
- Dimensions: 6.5 x 6.93 x 5.67in
- Voltage: 12 Volt
- Terminal Type: M6 + TP26
- CCA: 410
- CA or MCA: 530
- HCA: 625
- PHCA: 925
- Capacity: @ 20hr Rate: 28
- Reserve Capacity @ 25 Amps: 48
- Reserve Capacity @ 75 Amps: 6
- Watts: 900
- Internal Resistance: 9.1mΩ



CYCLING CAPACITY		RESERVE CAPACITY	
20 Hour Rate	<b>28 Amp Hours</b>	Reserve @25 AMPS	<b>48 Minutes</b>
		Reserve @75 AMPS	<b>10.1 Minutes</b>
ELECTRICAL SPECIFICATIONS		MECHANICAL SPECIFICATIONS	
Nominal Voltage	<b>12 Volt</b>	Group Size	-
C100	<b>31 AH</b>	Terminal Type	<b>M6 + TP26 (SAE)</b>
C20	<b>28 AH</b>	Terminal Torque	See reverse side
CS	<b>23 AH</b>	Height (w/ terminal)	<b>5.64"</b> 144 mm
Short Circuit Current	<b>1382 Amps</b>	Height (case only)	<b>4.92"</b> 125 mm
CCA	<b>410 Amps</b>	Width	<b>6.93"</b> 176 mm
CA or MCA	<b>530 Amps</b>	Length	<b>6.50"</b> 165 mm
PHCA	<b>925 Amps</b>	Weight	<b>23.6 lbs</b> 10.7 kg
Internal Resistance	<b>6.6 mΩ</b>	Case Type	<b>ABS Plastic - Flame Res. Rating UL94-HB</b>

**900 WATTS**

**ODYSSEY**  
**BATTERY**  
CROSS-REFERENCE  
**PC925**



**FT560**

**1200 WATT HIGH PERFORMANCE AGM BATTERY**

- Weight: 33.29 lbs
- Dimensions: 7.8 x 6.54 x 7.09in
- Group Size: 26R
- Voltage: 12 Volt
- Terminal Type: M6 + TP26
- CCA: 560
- CA or MCA: 725
- HCA: 860
- PHCA: 1200
- Capacity: @ 20hr Rate: 44
- Reserve Capacity @ 25 Amps: 80
- Reserve Capacity @ 75 Amps: 14.2
- Watts: 1200
- Internal Resistance: 4.5mΩ



CYCLING CAPACITY	
20 Hour Rate	<b>44 Amp Hours</b>

RESERVE CAPACITY	
Reserve @25 AMPS	<b>80 Minutes</b>
Reserve @75 AMPS	<b>14.2 Minutes</b>

ELECTRICAL SPECIFICATIONS	
Nominal Voltage	12 Volt
C100	48 AH
C20	44 AH
C5	35 AH
Short Circuit Current	2600 Amps
CCA	560 Amps
CA or MCA	725 Amps
PHCA	1200 Amps
Internal Resistance	2.7 mΩ

MECHANICAL SPECIFICATIONS	
Group Size	-
Terminal Type	M6 + TP26 (SAE)
Terminal Torque	See reverse side
Height (w/ terminal)	7.08" 180 mm
Height (case only)	6.69" 170 mm
Width	6.54" 166 mm
Length	7.80" 198 mm
Weight	33.3 lbs 15.1 kg
Case Type	ABS Plastic - Flame Res. Rating UL94-HB

**1200 WATTS**

**ODYSSEY**  
**BATTERY**  
CROSS-REFERENCE  
**PC1200**



**FT825-34**

**2000 WATT HIGH PERFORMANCE AGM BATTERY**

- Weight: 46.08 lbs
- Dimensions: 10.28 x 6.77 x 8.19in
- Group Size: 34
- Voltage: 12 Volt
- Terminal Type: M8 + TP28
- CCA: 825
- CA or MCA: 1000
- HCA: 1200
- PHCA: 1500
- Capacity: @ 20hr Rate: 65
- Reserve Capacity @ 25 Amps: 135
- Reserve Capacity @ 75 Amps: 22
- Watts: 2000
- Internal Resistance: 5.1mΩ



CYCLING CAPACITY	
20 Hour Rate	<b>44 Amp Hours</b>

RESERVE CAPACITY	
Reserve @25 AMPS	<b>80 Minutes</b>
Reserve @75 AMPS	<b>14.2 Minutes</b>

ELECTRICAL SPECIFICATIONS	
Nominal Voltage	12 Volt
C100	48 AH
C20	44 AH
C5	35 AH
Short Circuit Current	2600 Amps
CCA	560 Amps
CA or MCA	725 Amps
PHCA	1200 Amps
Internal Resistance	2.7 mΩ

MECHANICAL SPECIFICATIONS	
Group Size	-
Terminal Type	M6 + TP26 (SAE)
Terminal Torque	See reverse side
Height (w/ terminal)	7.08" 180 mm
Height (case only)	6.69" 170 mm
Width	6.54" 166 mm
Length	7.80" 198 mm
Weight	33.3 lbs 15.1 kg
Case Type	ABS Plastic - Flame Res. Rating UL94-HB

**2000 WATTS**

**ODYSSEY**  
**BATTERY**  
CROSS-REFERENCE  
**34-PC1 500**

**OPTIMA**  
**BATTERIES**  
CROSS-REFERENCE  
**34 #8002-002**  
**D34 #8012-021**



**FT930-65**

**2400W HIGH PERFORMANCE AGM BATTERY**

- Weight: 54.90 lbs
- Dimensions: 11.81 x 7.17 x 7.24in
- Group Size: 65
- Voltage: 12 Volt
- Terminal Type: M8 + TP28
- CCA: 930
- CA or MCA: 1070
- HCA: 1350
- PHCA: 1750
- Capacity: @ 20hr Rate: 75
- Reserve Capacity @ 25 Amps: 168
- Reserve Capacity @ 75 Amps: 26.1
- Internal Resistance: 3.1mΩ



CYCLING CAPACITY		RESERVE CAPACITY	
20 Hour Rate	<b>75 Amp Hours</b>	Reserve @25 AMPS	<b>142 Minutes</b>
		Reserve @75 AMPS	<b>26.1 Minutes</b>

ELECTRICAL SPECIFICATIONS		MECHANICAL SPECIFICATIONS	
Nominal Voltage	<b>12 Volt</b>	Group Size	<b>65</b>
C100	<b>82 AH</b>	Terminal Type	<b>M8 + TP28 (SAE)</b>
C20	<b>75 AH</b>	Terminal Torque	<b>See reverse side</b>
C5	<b>60 AH</b>	Height (w/ terminal)	<b>7.36" 184 mm</b>
Short Circuit Current	<b>4000 Amps</b>	Height (case only)	<b>6.69" 170 mm</b>
CCA	<b>930 Amps</b>	Width	<b>7.17" 182 mm</b>
CA or MCA	<b>1070 Amps</b>	Length	<b>11.81" 300 mm</b>
PHCA	<b>1750 Amps</b>	Weight	<b>57.5 lbs 26.1 kg</b>
Internal Resistance	<b>2.0 mΩ</b>	Case Type	<b>ABS Plastic - Flame Res. Rating UL94-HB</b>

**2400 WATTS**

**ODYSSEY**  
**BATTERY**  
CROSS-REFERENCE  
**65-PC1750**



**FT1100-31**

**4000W HIGH PERFORMANCE AGM BATTERY**

- Weight: 75.18 lbs
- Dimensions: 12.99 x 6.81 x 9.13in
- Group Size: 31
- Voltage: 12 Volt
- Terminal Type: M8 + TP28
- CCA: 1100
- CA or MCA: 1360
- HCA: 1560
- PHCA: 2200
- Capacity: @ 20hr Rate: 110
- Reserve Capacity @ 25 Amps: 230
- Reserve Capacity @ 75 Amps: 50
- Internal Resistance: 2.3mΩ



CYCLING CAPACITY		RESERVE CAPACITY	
20 Hour Rate	<b>110 Amp Hours</b>	Reserve @25 AMPS	<b>230 Minutes</b>
		Reserve @75 AMPS	<b>50 Minutes</b>

ELECTRICAL SPECIFICATIONS		MECHANICAL SPECIFICATIONS	
Nominal Voltage	<b>12 Volt</b>	Group Size	<b>31</b>
C100	<b>121 AH</b>	Terminal Type	<b>M8 + TP28</b>
C20	<b>110 AH</b>	Terminal Torque	<b>See reverse side</b>
C5	<b>91 AH</b>	Height (w/ terminal)	<b>9.13" 232 mm</b>
Short Circuit Current	<b>5000 Amps</b>	Height (case only)	<b>8.43" 214 mm</b>
CCA	<b>1150 Amps</b>	Width	<b>6.81" 173 mm</b>
CA or MCA	<b>1360 Amps</b>	Length	<b>12.99" 330 mm</b>
PHCA	<b>2200 Amps</b>	Weight	<b>77.4 lbs 35.1 kg</b>
Internal Resistance	<b>2.2 mΩ</b>	Case Type	<b>ABS Plastic - Flame Res. Rating UL94-HB</b>

**4000 WATTS**

**ODYSSEY**  
**BATTERY**  
CROSS-REFERENCE  
**PC2150**  
**OPTIMA**  
**BATTERIES**  
CROSS-REFERENCE  
**D31A #8051-160**



**LBCP-12-6**

**20 AMP POWER SUPPLY**

- Input voltage: AC 115V/60Hz
- Rated Power: 103W
- Output Voltage: 12V DC
- Rated Current: 4.2A
- Peak Current: 6A
- Battery Types: 12V DC (Lead-acid battery)
- Battery Capacity: 14-84Ah
- Plastic shell
- Overheating protection
- Short circuit protection



**12 VOLT**  
**6 AMP**

**LBCH-612SW**

**6 AMP POWER SUPPLY**

- Intelligent charge technology, multi-stage 6/12V 6A charging for added precision, safety and battery life
- Blade Type Fuse
- Overload Protection
- Fast Charging
- Comes with 6ft power cord and 4ft DC output cords with alligator clips
- Shockproof and corrosion proof



**6/12 VOLT**  
**6 AMP**

**LBCH-12M**

**BATTERY CHARGER**

- Double Insulated
- Thermal Overload Safety
- Electronic LED Display
- CE Approved
- For 12V Car, Motorcycle & Lawnmower Batteries
- 6/12V, 12 Amp



**6/12 VOLT**  
**12 AMP**

**LBCH-6M**

**BATTERY CHARGER**

- Double Insulated
- Power Supply
- Thermal Overload Safety
- Electronic LED Display
- CE Approved
- For 12V Car, Motorcycle & Lawnmower Batteries
- 6/12V, 6 Amp



**6/12 VOLT**  
**12 AMP**

**LBCH-80M**

**BATTERY CHARGER**

- Thermal Overload Safety
- Electronic LED Display
- CE Approved
- For 12V Car, Motorcycle & Lawnmower Batteries
- 12V, 20 Amp
- Power supply mode provides stable power to maintain system voltage for use in a wide variety of applications
- This charger also has an 80 amp Engine Start charging capability
- Easily switch between trickle charge or heavy duty charge



**12 VOLT - 20 AMP**



**EX-JUMP6-16**

**6 GA - 16FT JUMPER CABLE**

- 6Ga, 16 FT.
- Tangle Free Construction
- Phase Marked Clamps for Added Safety
- High/Low Temperature Construction
- Extra Flexible



**EX-JUMP4-20**

**4 GAUGE - 20FT JUMPER CABLE**

- 4Ga, 20 FT.
- Tangle Free Construction
- Phase Marked Clamps for Added Safety
- High/Low Temperature Construction
- Extra Flexible for Easy Use



**NB-770**

**POWER INVERTER BATTERY CABLE**

- 70A
- 10ft Length
- 12Ga
- Two alligator clamp on one end and two ring terminals on the other end



**NB-880**

**POWER INVERTER BATTERY CABLE**

- 80A
- 10ft Length
- 10Ga
- Two alligator clamp on one end and two ring terminals on the other end



**NB-440 BLK/RED (30 AMP)**

**NB-550 BLK/RED (50 AMP)**

**NB-660 BLK/RED (60 AMP)**

**CLIPS**

- Battery Clips



**TRBM-12-125A**

**AUTOMATIC BATTERY MAINTAINER & FLOAT CHARGER**

- Switch - Mode Technology
- Input: 110V AC, 60Hz, 0.25A
- Output: 12V Nominal, 0.75A
- Standby Power Consumption: <0.5W
- Maximum Operating Temperature: (122°F (50°C))



**TRBM-1224-6A**

**INTELLEGENT BATTERY CHARGER**

- Input Voltage: 110V AC, 60Hz or 230V AC, 50Hz
- Output Voltage: 12V & 24V (auto - select)
- Charging Voltage: 28.8V ± 0.25V, or 29.4V ± 0.25V or 14.4V ± 0.25V or 13.6V ± 0.25V or 16.5V ± 0.25V
- Charging Current: 6.0A ± 10% or 4.0A ± 10% or 3.0A ± 10% or 2.5A ± 10% or 1.5A ± 10%
- Ambient Temp: -20°C ~ +40°C / -4°F ~ 104°F, Reduced Output Power at Higher Temperature
- Battery Types: 12V & 24V Lead-Acid Batteries (WET, MF, AGM and GEL)



**IS-QFH18**

**FUSE CABLE**

- Vinyl Ring Tounge Termnal
- ATC 7.5 AMP Blade type Fuse Included
- Quick Disconnect Power Cable
- 2' Long



### TRMB-12-1.5A

#### AUTOMATIC BATTERY CHARGER

- Input: 100-240V AC, 50/60Hz, 0.45A
- Output: 12V DC 1.5A
- LED Indicator: Red-Charging/Green-Charged
- Lead-acid battery charger, specifically used for lamps, toys, solar energy equipment, etc.



### IS-CLE12

#### 12V - 12' CIGARETTE LIGHTER EXTENSION CABLE

- 12' length
- Wire gauge: 18 AWG
- 100% copper wire
- High quality molded cable for strength and durability
- Male plug is fitted with a 15A fuse to protect your vehicle and devices and has LED light indication of power on
- Female plug is fitted with a dust and water protective cap
- Perfect for your favorite 12 Volt devices, like car tire inflators, spot lamps, cell phones, cooking appliances, car TV, vacuum cleaner and more.



### NP-210

#### CIGARETTE LIGHTER PLUG TO TWO FEMALE JACKS

- 3' length
- 12V DC
- 1 male cigarette lighter plug to 2 female receptacles
- Allows VCR, Video light or TV monitor hookups
- Simultaneous CB and Radar operation



**CMP-10012**

**12V DC PORTABLE AIR COMPRESSOR**

- Voltage: 12-14V DC
- Amperage: 15 Amps
- Air Flow: 25 LPM@0 PSI
- Max. Pressure: 100 PSI
- For use on car tires, sports equipment & more
- Compact & powerful pump motor
- Built-in carry handle
- Nozzle adaptors included

**25 LPM  
AIR FLOW**

Conveniently Plug directly into Cigarette Lighter Socket of your Vehicle. Multiple Uses: Inflate tires on cars, bikes, sedan and midsize SUV. Universal valve connector for schrader valve is ready to use. Additional adapters include needles valve (for basketball, balls), short cone/long cone adapters (for inflatable kayak, swimming pool accessories, etc)



**CMP-15015-B**

**12V DC PORTABLE AIR COMPRESSOR**

- Voltage: 12-14V DC
- Amperage: 15 Amps
- Air Flow: 30 LPM@0 PSI
- Max. Pressure: 150 PSI
- For use on car tires, sports equipment & more
- Compact & powerful pump motor
- Built-in carry handle
- Nozzle adaptors included
- Carry bag included

**30 LPM  
AIR FLOW**

Conveniently Plug directly into Cigarette Lighter Socket of your Vehicle. Multiple Uses: Inflate tires on cars, bikes, sedan and midsize SUV. Universal valve connector for schrader valve is ready to use. Additional adapters include needles valve (for basketball, balls), short cone/long cone adapters (for inflatable kayak, swimming pool accessories, etc)



**CARRY BAG  
INCLUDED**



**THSY-6075-CST**

**1 GALLON TANK AIR COMPRESSOR KIT**

- This on-board system is designed for use with any high-pressure air horn that requires an on-board air system
- Comes with a 3.5 liter air tank, heavy duty compressor, fuse, hose, fittings, thread sealant, and mounting hardware
- Ideal for all vehicles with a 12V DC system
- Air hose: 5mm diameter, 330mm length
- Anti-corrosion coating
- Precision welded
- Tank dimensions: 13" x 5" x 5.5"



**12 DC 15 A 3.5 LITER 1 GALLON**

**MADE IN TAIWAN**

**THSY-6150-CST**

**1.5 GALLON TANK AIR COMPRESSOR KIT**

- This on-board system is designed for use with any high-pressure air horn that requires an on-board air system
- Comes with a 5.6 liter air tank, heavy duty compressor, fuse, hose, fittings, thread sealant, and mounting hardware
- Ideal for all vehicles with a 12V DC system
- Air hose: 6mm diameter, 330mm length
- Anti-corrosion coating
- Precision welded
- Tank dimensions: 19" x 5" x 5.5"
- Compressor dimensions: 6.5" x 6.5" x 4.5"



**12 DC 15 A 5.6 LITER 1.5 GALLON**

**MADE IN TAIWAN**

**THSY-3075C**

**3 LITER TANK AIR COMPRESSOR**

- Pressure: 90~120 PSI
- Output: 12V DC
- Volume: 3L (0.79 Gal)



**THSY-5150C**

**6 LITER TANK AIR COMPRESSOR**

- Pressure: 90~120 PSI
- Output: 12V DC
- Volume: 6L (1.59 Gal)



**AIR COMPRESSORS**

**THSY-3075KIT**

**AIR COMPRESSOR MOTOR REPAIR KIT**

- Replacement for THSY-3075C air compressor



**THSY-5150KIT**

**AIR COMPRESSOR MOTOR REPAIR KIT**

- Replacement for THSY-5150C air compressor



**THSY-GAUGE**

**AIR COMPRESSOR GAUGE**

- Replacement gauge for THSY-3075C and THSY-5150C



**Side View**

**THSY-HOSE 25**

**AIR COMPRESSOR HOSE**

- Length: 25' (7.5M)
- 1/4" Ends Terminal made of Iron, GF High Pressure Resistant
- Compatible with THSY-3075C & THSY-5150C

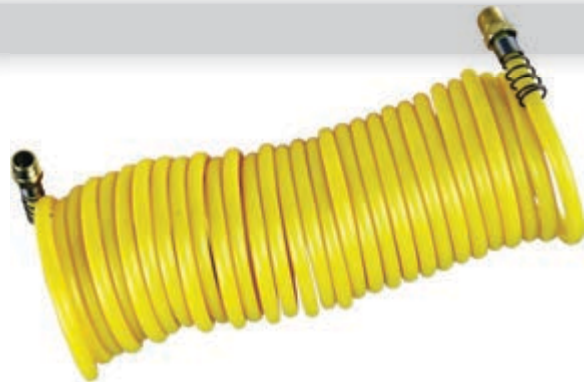

**THSY-HSE 7**

**AIR COMPRESSOR HOSE**

- 7'
- Compatible with:  
THSY-1075-HA  
THSY-1075H  
THSY-3075C  
THSY-5150C



**THSY-HSOLE**

**REPLACEMENT HORN SOLENOID**

- Voltage: 12V/24V
- Current: 3.6A
- Power: 48W
- Air Pressure Range: 0.2~0.8 MPa



**THSY-2050-CH**

**COMPACT AIR HORN COMPRESSOR SET**

- New Powerful High RPM Compressor
- Full Thermal Protection
- New Lubricating System
- Leak-Proof Nylon Hose
- Super Loud: 17 Decibels
- Use Air-Horn for Emergency Warning when on Highway, Mountain Road and Taking a Turn. Also Enriching Air for Car, Motorcycle, Ball, Yacht, Tire, Air-Free, Toys, etc.
- Small Size, Auto-Control Air Pressure, Excellent Very Loud Sound

**POWERFULL, LOUD SOUND IN A SMALL, COMPACT DESIGN**  
Our All-inclusive compact air Horn Kit is Primed with everything you need. this kit is ready for installation right out of the box!  
Our compressor/tank is pre-plumbed and even pre-wired!



**MADE IN TAIWAN**

**THSY-1615-CH3T**

**3-WAY TRAIN HORN**

- Will give any 12/24V DC off road vehicle or truck the powerful sound of a train air horn.
- Engineered with the latest technology using reinforced ABS
- The horns are operated by a heavy-duty 12/24V DC electric solenoid valve
- Overall Dimensions: 16.5" x 14.5" x 11"
- Trumpet Sizes: 16" x 7.3" / 14.4" x 7.3" / 10.4" x 6.0"

**12v DC 0.20 A**  
**24v DC 0.42 A**



**MADE IN TAIWAN**

**THSY-1412-YH4T**

**4-WAY TRAIN HORN**

- Gives and 12/24V DC off-road vehicle or truck the powerful sound of a train air horn
- The horns are operated by a heavy-duty 12/24V DC electric solenoid valve
- The trumpets are finished with an attractive and durable high-quality zinc material
- Mounting hardware included
- Overall Dimensions: 6" x 6" x 14"
- Trumpet Sizes: 14.2" x 3.7" / 11.8" x 3.7" / 9.1" x 3.7" / 7.9" x 3.7"

**12v DC 0.20 A**  
**24v DC 0.42 A**



**MADE IN TAIWAN**

**THSY-1075-EC**

**4-WAY TRAIN HORN**

- Material: Zinc Alloy totally Horns + Chromed Plastic Base,
- Smaller than THSY-1075H
- Size: 230\*93mm, 306\*96mm, 350\*96mm, 375\*96mm
- 12V/24V, JGK-505 Big VALVE (with Copper Coil)
- Weight: 1.5 Kgs
- 125 DB
- 290/421/548/648 HZ



**THSY-1075H**

**3-WAY TRAIN HORN**

- Air Pressure: 0.4~0.8MPa
- Current: 3.5-7.0A
- Voltage: 12-24V
- Sound Level: 125 ± 5dB



**THSY-1000**

**AIR COMPRESSOR & HORN KIT**

- DC 12V, 26.5A, 320W
- Material: Zinc Alloy Totally 2 Horns + Aluminum Base
- Size: 168 x Φ75mm, 207 x Φ76mm
- Weight: 0.95 Kgs
- 110 ± 5dB



**THSY-1075-H4**

**4-WAY TRAIN HORN**

- Material: Zinc Alloy Totally 4 Horns:
- 2 Small Horn: Length: 280mm, Diameter of the Mount 160mm
- 1 Media Horn: Length: 344mm, Diameter of the Mount 160mm
- 1 Large Horn: Length: 396mm, Diameter of the Mount 160mm
- 12V/24V, JGK-505VALVE (with Copper Coil)
- Weight: 6 Kgs
- 125 DB
- 290/421/548/648 HZ



**IS-DL-1254-REC**

**SNAIL HORN**

- Frequency: 400/500Hz
- Decibel: 105-118dB(A)
- Operating Voltage: 12V
- Two-tone fanfare horns
- 100% purecopper coil
- Strong Sound & Audible Safety: Always a strong and clear tone, even under tough conditions
- Long Life & Reliability: Membrane Filter Technology for increased performance and protection against corrosion, dirt & humidity
- OE Quality: Homologated according to ECE Standard and designed according to OE specifications
- For Passenger Cars
- Optimal performance in Urban & Overland Traffic



**100%**  
Purecopper  
Coil

**12V**  
Operating  
Voltage

**MOST COMMON IN AMERICAN TYPE CARS**

**IS-DL-1254-SQR**

**SNAIL HORN**

- Frequency: 400/500Hz
- Decibel: 105-118dB(A)
- Operating Voltage: 12V
- Two-tone fanfare horns
- 100% purecopper coil
- Strong Sound
- Audible Safety: Always a strong and clear tone, even under tough conditions
- Long Life & Reliability: Membrane Filter Technology for increased performance and protection against corrosion, dirt & humidity
- OE Quality: Homologated according to ECE Standard and designed according to OE specifications
- For Passenger Cars
- Optimal performance in Urban & Overland Traffic



**100%**  
Purecopper  
Coil

**12V**  
Operating  
Voltage

**MOST COMMON IN JAPANESE TYPE CARS**



**DL-1202LT**

**SNAIL HORN**

- Loud Factory Sounding Tone
- Easily Replaces OEM Horn
- Zinc Plating Avoids Corrosion
- Easy to Install



**DL-1202HT**

**SNAIL HORN**

- Loud Factory Sounding Tone
- Easily Replaces OEM Horn
- Zinc Plating Avoids Corrosion
- Easy to Install



**NTX-5000G (Gold Plastic)**

**NTX-5700ALG (Gold Aluminum)**

**SIREN**

- Siren Output: 112 dB
- Size: Ø130 x 125
- Output Power: 250W (P.M.P.O)  
125W (P.M.P.O)
- Impedance: 8 Ohms
- Frequency Range:  
1,800Hz ~ 20,000kHz



**NTX-5000CHR**

**SIREN**

- Siren Output: 112 dB
- Size: Ø130 x 125
- Output Power: 250W (P.M.P.O)  
125W (P.M.P.O)
- Impedance: 8 Ohms
- Frequency Range: 1,800Hz ~ 20,000kHz



**AV-100G**

**4" 6 TONE SIREN**

- Siren Output: 119 dB
- Operation Power: 12V, 35W
- Sensitivity: 119dB± 3db
- Impedance: 8 Ohms



**NL-HHKT-7**

**VINYL BRAIDED HORN WIRING HARNESS**

- Horn wiring harness for car horns, air car horns wiring harness connection diagram
- Easy and Simple installation, plug-in play style connection. Make the horns more durable.
- Compatible with many aftermarket vehicle accessories needing an on/off switch.
- 40 Amp
- The overall length of the harness: 2M / 6.6'
- Requires switch



**ISRS-350**

**3.5" DUAL CONE CAR SPEAKER**

- Output Power: 45 Watts (P.M.P.O.)  
20Watts (R.M.S.)
- Frequency Response: 92Hz~15KHz
- Sensitivity: 88dB/W(1M)
- Impedance: 4 Ohm



**PERFECT FACTORY  
REPLACEMENT**

**ISRS-400**

**4" DUAL CONE CAR SPEAKER**

- Output Power: 45 Watts (P.M.P.O.)  
20Watts (R.M.S.)
- Frequency Response: 92Hz~15KHz
- Sensitivity: 88dB/W(1M)
- Impedance: 4 Ohm



**PERFECT FACTORY  
REPLACEMENT**

**ISRS-460**

**4 X 6" DUAL CONE CAR SPEAKER**

- Output Power: 75 Watts (P.M.P.O.)  
35Watts (R.M.S.)
- Frequency Response: 52Hz~2KHz
- Sensitivity: 88dB/W(1M)
- Impedance: 4 Ohm



**ISRS-500**

**5.25" DUAL CONE CAR SPEAKER**

- Output Power: 65 Watts (P.M.P.O.)  
30Watts (R.M.S.)
- Frequency Response: 88Hz~15KHz
- Sensitivity: 88dB/W(1M)
- Impedance: 4 Ohm



**ISRS-600**

**6" DUAL CONE CAR SPEAKER**

- Output Power: 75 Watts (P.M.P.O.)  
35 Watts (R.M.S.)
- Frequency Response: 88Hz~15KHz
- Sensitivity: 88dB/W(1M)
- Impedance: 4 Ohm



**ISRS-680**

**6 X 8" DUAL CONE CAR SPEAKER**

- Output Power: 70 Watts (P.M.P.O.)  
35 Watts (R.M.S.)
- Frequency Response: 88Hz~15KHz
- Sensitivity: 89dB/W(1M)
- Impedance: 4 Ohm



**ISRS-690**

**6 X 9" DUAL CONE CAR SPEAKER**

- Output Power: 75 Watts (P.M.P.O.)  
35 Watts (R.M.S.)
- Frequency Response: 52Hz~2KHz
- Sensitivity: 89dB/W(1M)
- Impedance: 4 Ohm



**ISPOD-WD260-BLK**

**DUAL 6" DOOR WOOD SPEAKER POD**

- Audiopipe aluminum logo badge
- Can be mounted on door panels or rear decks
- Inner cylinder provides a solid enclosure
- High grade vinyl wrap
- **SOLD INDIVIDUALLY**



**ISPOD-WD280-BLK**

**DUAL 8" DOOR WOOD SPEAKER POD**

- Audiopipe aluminum logo badge
- Can be mounted on door panels or rear decks
- Inner cylinder provides a solid enclosure
- High grade vinyl wrap
- **SOLD INDIVIDUALLY**



**ISPOD-WD8T-BLK**

**8" WOOD SPEAKER POD WITH TWEETER OPENING**

- Audiopipe aluminum logo badge
- Can be mounted on door panels or rear decks
- Compatible with ATX-3725 tweeter
- Inner cylinder provides a solid enclosure
- High grade vinyl wrap
- **SOLD BY PAIRS**



**TUBO-6.5 (6.5")**

**TUBO-8 (8")**

**TUBO-10 (10")**

**TUBO-12 (12")**

**PORTED SUBWOOFER ENCLOSURE**

- Grade A
- 5/8" MDF Construction
- Ported Vent
- Charcoal Carpet Covering
- Solid Wood Construction
- Terminal Cup Connector
- Single Chamber Design
- Weight: 19 Lbs
- Dimensions: 18" L x 11" in diameter (including the vent slot)

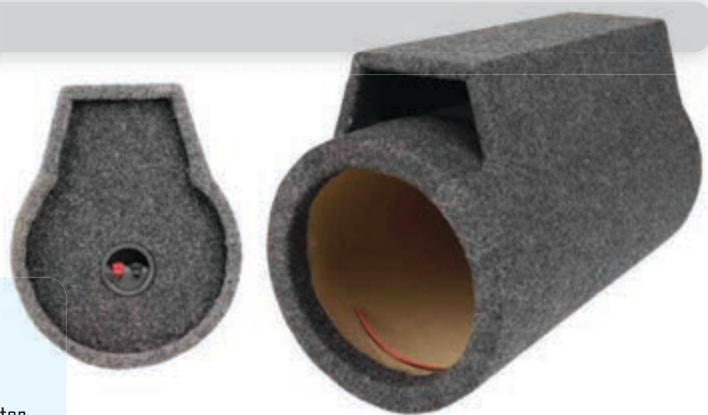

**SPEAKERS RINGS**

- RING-06CBK (6")
- RING-065CBK (6.5")
- RING-69CBK (6x9")
- RING-08CBK (8")

**SPEAKER RINGS**

- MDF Speaker Rings with Black Carpet
- 3/4" Thickness
- Sold in Pairs



- RING-PVC-TY-6
- 6" PVC RING

▪ ???

**CHECK INFO  
& IMAGE???**

- RING-8CTW
- 8" SPEAKER RING WITH OPENING FOR TWEETER

- 8" Wood Rings with Curve (Pair)
- Each Ring Accommodates 8" Speakers and 1 ATR-3721 or ATQ-3725 Series Tweeter
- Provides a Custom Look to your Door Panel or Rear Deck and Acts like a Spacer
- Sold in Pairs



- RING-PVC-NI-6
- 6" PVC RING

▪ ???

**CHECK INFO  
& IMAGE???**

- RING-4545
- MDF SPEAKER RING

- Inner Diameter: 3.3"
- Outer Diameter: 4.48"
- Sold in Pairs



- RING-5757
- MDF SPEAKER RING

- Inner Diameter: 4.4"
- Outer Diameter: 5.65"
- Sold in Pairs



- RING-H537
- MDF SPEAKER RING

- Inner Diameter: 5.37"
- Outer Diameter: 6.5"
- Sold in Pairs



**COMPATIBLE WITH THESE  
AUDIOPIPE HORNS:**  
APH-5757 / APH-6556 / APH-9460  
APH-603080-H / APH-605080-H  
APH-625080-H / APHC-6256  
APHC-6278

Great for fiberglass, kick pods, and baffles. Please note that due to the pressed wood material used for these rings, they are very easily customizable for specific sizes. These rings can be shaved or filed down for an in-between size or for a more custom fit.

**SPEAKERS RINGS**

**POPULAR**

- RING-3.5R (3.5")
- RING-4R (4")
- RING-5.25R (5.25")
- RING-6.5R (6.5")
- RING-8R (8")
- RING-10R (10")
- RING-12R (12")

**MDF SPEAKER RINGS**

- Sold in Pairs



This product is a real time and finger saver. Don't risk it. You can router out you own MDF speaker rings but, you risk loosing some skin or worse. We took the average size speaker and made these to fit most all speakers on the market. Great for fiberglass kick pods and baffles.

**POPULAR**

- RING-6.5BZ (6.5")
- RING-8BZ (8")
- RING-10BZ (10")
- RING-12BZ (12")

**MDF SPEAKER RINGS WITH BEZEL**

- Sold in Pairs



- RING-6.5GR (6.5")
- RING-8GR (8")

**MDF SPEAKER RINGS WITH GRILL CUT-OUT**

- Sold in Pairs



**RING-3720**

**MDF TWEETER RING**

- Sold in Pairs



**COMPATIBLE WITH THESE AUDIOPIPE TWEETERS:**  
ATR-3723B  
ATR-3723C  
ATR-3721

- APMB-RING-6 (6")
- APMB-RING-8 (8")

**ABS PLASTIC SPEAKER RINGS**

- Made From ABS Plastic
- Adds an Extra Half Inch to Available Mounting Depth
- One Pair of Adapters Included in Each Package



**RING-PVC 6**

**6" PVC RING**

- Universal 1" Speaker Spacer Rings for Mounting 6.5" Speaker
- Inner Diameter: 5-7/8"
- Made From PVC Material
- 1-inch Allows Extra Mounting Depth
- Fits most 6.5 inch Speakers
- Oversized 6.5" Speakers will not work with these Spacers
- Sold in pairs



**APMB-RING-69**

**6 X 9" PLASTIC SPEAKER DEPTH EXTENDER**

- Inner Dimensions: 8.25 x 6.125"
- Outer Dimensions: 11.3125 x 7.5"
- Made from ABS Plastic
- Black Color
- Sold in pairs

**EXCLUSIVELY  
MADE TO FIT OUR  
APMB DIE CAST  
BASKET MODELS**



**IS-ACBAF-65**

**6.5" SPEAKER BAFFLE**

- Material: Silicone
- Front ring is foldable to guide the sound wave into vehicle
- Rear foldable ring fits different door depth and speaker heights. No need to trim.
- Rear foldable ring protects speaker and improves sound
- Silicone material is soft, allowing for best seal between speaker and door panel
- Silicone material is durable for harsh environment
- The sound wave foam installs behind the speaker to improve overall sound performance



**IS-ACBAF-80**

**8" SPEAKER BAFFLE**

- Material: Silicone
- Front ring is foldable to guide the sound wave into vehicle
- Rear foldable ring fits different door depth and speaker heights. No need to trim.
- Rear foldable ring protects speaker and improves sound
- Silicone material is soft, allowing for best seal between speaker and door panel
- Silicone material is durable for harsh environment
- The sound wave foam installs behind the speaker to improve overall sound performance



**IS-ACBAF-69**

**6 X 9" SPEAKER BAFFLE**

- Material: Silicone
- Front ring is foldable to guide the sound wave into vehicle
- Rear foldable ring fits different door depth and speaker heights. No need to trim.
- Rear foldable ring protects speaker and improves sound
- Silicone material is soft, allowing for best seal between speaker and door panel
- Silicone material is durable for harsh environment
- The sound wave foam installs behind the speaker to improve overall sound performance

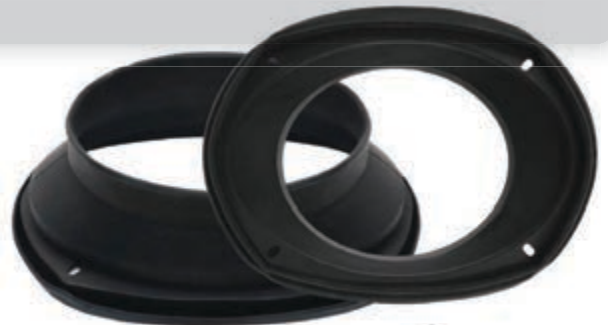

**CREATES A TIGHT, ACOUSTIC  
SEAL BEHIND THE SPEAKER  
TO ENHANCE THE SOUND QUALITY**



- IS-SP-14-1000BR (14 Gauge)
- IS-SP-16-1000BR (16 Gauge)
- IS-SP-18-1000BR (18 Gauge)
- IS-SP-20-1000BR (20 Gauge)

**SPEAKER CABLES**

- 1000 FT



- IS-SP-10-500CL (10 Gauge)
- IS-SP-12-500CL (12 Gauge)

**SPEAKER CABLES**

- 500 FT



- IS-SP-14-1000CL (14 Gauge)
- IS-SP-16-1000CL (16 Gauge)
- IS-SP-18-1000CL (18 Gauge)

**SPEAKER CABLES**

- 1000 FT



**IS-K800**

**AMPLIFIER INSTALLATION KIT**

- 17' 10GA Red Power Cable
- 3' 10GA Black Power Cable
- 15' 2-RCA to 2-RCA Plugs Cable with Signal Wire
- 3' Split Loom Tubing
- 10 AWG Fuse Holder
- 30A ATC Fuse
- 10 Pcs. Cable Ties
- Ring Terminal 1+1 Pcs
- 5 Spade Terminal
- 2 Butt Splices



**IS-K1700**

**AMPLIFIER INSTALLATION KIT**

- 17' 8GA Red Power Cable
- 3' 8GA Black Power Cable
- 17' 2-RCA to 2-RCA Plugs Cable with Signal Wire
- 3' Split Loom Tubing
- AFC Fuse Holder
- 60AAFC Fuse
- 10 Pcs. Cable Ties
- Ring Terminal 1+1 +1 Pcs
- 3 Spade Terminal
- 2 Butt Splices



**IS-K2500**

**AMPLIFIER INSTALLATION KIT**

- 17' 4GA Red Power Cable
- 3' 4GA Black Power Cable
- 17' 2-RCA to 2-RCA Plugs Cable with Signal Wire
- 3' Split Loom Tubing
- AFC Fuse Holder
- 100AAFC Fuse
- 10 Pcs. Cable Ties
- Ring Terminal 1+1 Pcs
- Spade Terminal 2 Pcs
- Butt Splices 2 Pcs



**IS-K3500**

**AMPLIFIER INSTALLATION KIT**

- 17' 0GA Red Power Cable
- 3' 0GA Black Power Cable 17'
- 2-RCA to 2-RCA Plugs Cable with Signal Wire
- 3' Split Loom Tubing
- ANL Fuse Holder
- 250AANL Fuse
- 10 Pcs. Cable Ties
- Ring Terminal 1 +1 Pcs
- Spade Terminal 2 Pcs
- Butt Splices 2 Pcs



**IS-K1700P**

**PLATINUM AMPLIFIER  
INSTALLATION KIT**

- 17' 8GA Blue Power Cable
- 3' 8GA Silver Power Cable
- 17' 2-RCA to 2-RCA Plugs Cables with Signal Wire
- 3' Split Loom Tubing
- AFC Fuse Holder
- 60A AFC Fuse
- 10 Pcs Cable Ties
- Ring Terminal 1+1+1 Pcs
- Spade Terminal 3 Pcs
- Butt Splices 2 Pcs



**IS-K2500P**

**PLATINUM AMPLIFIER  
INSTALLATION KIT**

- 17' 4GA Blue Power Cable
- 3' 4GA Silver Power Cable
- 17' 2-RCA to 2-RCA Plugs Cables with Signal Wire
- 3' Split Loom Tubing
- AFC Fuse Holder
- 100AAFC Fuse
- 10 Pcs Cable Ties
- Ring Terminal 1+1 Pcs
- Spade Terminal 2 Pcs
- Butt Splices 2 Pcs



**NOW INCLUDES:  
60A AFC Holder & Fuse**

**NOW INCLUDES:  
100A AFC Holder & Fuse**



**IS-RVDVR-43**

**FRONT/ REAR VIEW CAMERA WITH 4.3" MONITOR AND DVR**

- HD Camera, HD Video
- Camera lens: 150 degree A+high resolution ultra wide angle lens
- Language: English, Spanish, Portuguese, Japanese, French, German, Chinese (Simplified).
- File format: AVI
- Video resolution: Maximum 720P
- Video format: M-JPEG
- Loop video: Seamless video
- Supports auto ignition startup
- Supports Mobile detection function
- Photographic mode: 500 pixels
- Photo format: JPEG
- Memory card: TF (maximum support 32GB)
- Built-in stereo
- Video format: PAL/NTSC
- Current frequency: 50/60Hz
- USB function: 1: USB-Disk. 2: PC camera
- Power supply interface: 5V 1 A
- Built in battery
- Built-in Microphone



**4.3IN SCREEN**

**IS-RVDVR-96**

**FRONT/ REAR VIEW CAMERA WITH 9.6" MONITOR AND DVR**

- LCD: 9.6", IPS320 x 1280
- Camera lens: Front lens Angle: 160 °  
Rear lens Angle: 150 °
- Video compression standards: H.264
- Video sample rate: 30 fps
- Video resolution: 1080 x 1296
- Photographic resolution: 1080 x 1920
- Language: English, Spanish, Portuguese Japanese, French, Chinese (Simplified).
- Full screen capacitive touch
- Built-in echo cancelling microphone
- G-Sensor: Supports for triaxial force indu
- Working current: <2Ah
- Sleep Current: <3mA
- Operating voltage range: 4.8V-5.5V
- Operating temperature range: -30°C-+75°C (-86°F-+167°F)
- Power supply mode: +5V 9.6IN



**9.6IN SCREEN**

**IS-RTC-420-TG**

**CAR REVERSE CAMERA**

- Night vision Camera
- Mounts behing tag
- Voltage: 9V-15V DC
- Power consumption: Max 1W
- Image sensor: Color CMOS
- Total Pixels: 648 x 488 pixels
- Resolution: 600 TVL
- View Angle: 170 degree
- Led num: 4 LED
- Video output: 1.0 Vpp composite video at 75ohm



**600TVL RESOLUTION - 0 LUX MINI LUMINATION**

**REAR VIEW CAMERAS**

**IS-RVMR-43**

**REAR VIEW MIRROR MONITOR**

- 4.3" High Resolution Screen
- Power Input: 12V
- Display Format: 16:9
- The Brightness of the Screen will Adjust Automatically to its Environment's Lighting Conditions



**HD** **4.3IN**  
**SCREEN**

**IS-RVC-185GL**

**CAR REAR VIEW CAMERA WITH GRID LINES**

- Water-proof & Dust-proof
- High definition
- Night Vision
- Wide Angle
- Voltage: 8-15V
- Size:  $\Phi 0.73" \times 0.87" (H)$   
[ $\Phi 18.5 \times 22 (H)mm$ ]
- Accessories: Camera x 1, Video Cable x 1, Power Cable x 1 &  $\Phi 0.73" (18.5mm)$  Hole Saw x 1



**120°/170° WIDE ANGLE**  
**WATER PROFF**  
**WITH GRID LINES**

**IS-RLC-24SG-BLK**

**CAR REAR VIEW CAMERA**

- High Resolution
- Super Low Illumination
- Weather-Proof: IP 65
- Anti-Fog Function
- Wide Angle (120-170°)
- Easy to Install
- 9"x6-3/4"



**2.4GHZ**  
**WIRELESS**  
**CONNECTION** **300M**  
**VIEW RANGE**



**IS-RVC-170MI**

**CAR REAR VIEW CAMERA**

- Working Voltage: 10-15V (12V in car)
- Working Temperature: -20 °C~70°C
- Video: NTSC
- Water-Proof: IP67-IP68
- Min-Illumination: 0.1 LUX
- Resolution (TV LINES): 480



**480 TV LINES**  
**(RESOLUTION)**

**IS-RVC-S41TRJ**

**CAR REAR VIEW CAMERA**

- 4 LED Night Light
- Image Device: FPX8341 1/3 Color CMOS
- TV System: NTSC/PA can be Chosen
- Effective Pixel: 720 x 480
- IP Rating: IP67
- Definition: 600 TV Lines
- Reversing track dynamic lines



**4 LED NIGHT LIGHT FOR**  
**IMPROVED IMAGE QUALITY**  
**600 TV LINES**  
**(RESOLUTION)**



**IS-RVC-360ROT**

**CAR REAR VIEW CAMERA**

- Water-Proof & dust-Proof
- High Definition
- Night Vision
- 120 Degree Wide Angle View
- Voltage: 8 - 15V
- Size: 22.5 x 25mm



THIS REAR VIEW CAMERA IS THE PERFECT SOLUTION TO GET RID OF POOR REAR VIEW VISIBILITY ON YOUR CAR, BOAT, TRAILER, OR CAMPER

**IS-RVC-803GL**

**CAR REAR VIEW CAMERA**

- Connects to a RCA input and a 12 volt power source.
- Included: Mounting bracket, Hole saw (20mm), 36" power wiring and 6m RCA cable.
- Water-Proof & Dust-proof
- High Definition
- Night Vision & Wide Angle
- Voltage: 8-15V
- Size: Φ20 x 30(H) mm



**IS-BUP400-BLK**

**INTELLIGENT PARKING ASSISTANCE SYSTEM**

- Automatically Works when Reversing
- Digital LED Display
- Four Step Beep Alarm
- Detect Distance is 0-2m
- 4 Sensors
- Voltage: 9~15V DC
- Includes 4 Sensors
- Rated Voltage: 12V DC
- Power Time: <0.5W
- Response Time: 0.3~2.0m
- Sensor Diameter: 22mm
- Sensor Angle: x y 60°
- Alarm Volume: 65 dB



**IS-MVA4**

**1-4 VIDEO SPLITTER**

- One RCA Video Input
- Four RCA Video Output
- Video Input Level: 2.0Vpp
- Output Impedance: 75 Ohm
- Independent Video Level Control



A VERSATILE VIDEO SPLITTER FOR APPLICATIONS THAT REQUIRE VIDEO DISTRIBUTION TO MULTIPLE DISPLAYS OR LOCATION. TOTAL OF 4 REAL TIME DUPLICATED VIDEO OUTPUTS WITH NO LAGS.

**IS-BUP550-BLK**

**INTELLIGENT ASSISTANCE PARKING SYSTEM**

- Voltage: 9~15 DC
- Rated Voltage: 12V DC
- Power Consumption: < 0.5W
- Response Time: 0.3 ~ 2.0 m
- Sensor Diameter: 22mm
- Sensor Angle: x y 60°
- Alarm Volume: 65 dB
- Work Temperature: -30° C ~ 80° C
- FM (wireless): 433MHz / 2.4GHz



2 Pin



Tip Included



**9~15 DCV Voltage**  
**10 mW Power(Wireless)**

**IS-RVC-165GL**

**CAR REAR VIEW CAMERA**

- Water-Proof & Dust-Proof
- High Definition
- Night Vision & Wide Angle
- Voltage: 8-15V
- Size:  $\Phi 16.5 \times 22(H)$  mm



**IS-RVC-258GL**

**CAR REAR VIEW CAMERA**

- Water-Proof & Dust-Proof
- High Definition
- Night Vision & Wide Angle
- Voltage: 8-15V
- Size:  $\Phi 18 \times 20(H)$  mm



**IS-CF512**

**5" CROSS FLOW COOLING FAN**

- Compatible with all 12 volt systems
- Comes equipped with mounting tabs for simple installation
- Low profile cross flow design allows installation in tight fitting spaces
- Puts out 25 cubic feet of air flow per minute



**12V DC VOLTAGE**    **5"**

**IS-CF812**

**8" CROSS FLOW COOLING FAN**

- Compatible with all 12 volt systems
- Comes equipped with mounting tabs for simple installation
- Low profile cross flow design allows installation in tight fitting spaces
- Puts out 40 cubic feet of air flow per minute



**12V DC VOLTAGE**    **8"**

**FAN-33**

**COOLING FAN**

- 2 3/8" x 2 3/8" x 1"
- 28 Cubic Feet per Minute
- 12V 0.8A



**GRILL INCLUDED**

**FAN-55**

**COOLING FAN**

- 4 6/8" x 4 6/8" x 1.5"
- 106 Cubic Feet per Minute
- 12V 1.0A



**GRILL INCLUDED**

**FAN-550HS**

**HIGH SPEED COOLING FAN**

- 4.7" (H) x 4.7" (W) x 1.5" (D)
- Current: 2A, Power: 24W, DC 12V
- Speed: 4350RPM
- Two speed options



**POPULAR**

**FAN-4712LERG**

**COOLING FAN WITH LED**

- Product Size: 120 x 120 x 25 mm (4.7" x 4.7" x 1")
- Rated Voltage: 12V ( for fan)
- Rated Current: 1A
- Airflow: 36CFM
- Fan Speed: 2000 (±10% RPM)
- Sound Level: 21-34 dB
- Bearing Type: Hydraulic Bearing
- Lifetime: 30000Hrs
- Dual ring LED circle (12 LED lights automatically change)



Highly optimized low-noise design with outstanding static pressure and airflow (cfm), ideal for chasis ventilation

**IS-DB91832**

**SOUND DAMPENING MAT BULK PACKAGE**

- Damping Mat Bulk Package
- Included Nine (9) / 18" x 32" sheets
- 2.2mm thick
- Pure butyl
- Handles 40lb / sq inch
- Forget about unwanted road noise and create a quiet environment in your ride. Pipeman's Dampening Mat is easy to install and will improve your bass.



**18" x 32"**

**IS-DD61224**

**SOUND DAMPENING MAT BULK PACKAGE DOOR KIT**

- Damping Mat Bulk Package
- Included Nine (9) / 12" x 24" sheets
- 2.2mm thick
- Pure butyl
- Handles 40lb / sq inch
- Forget about unwanted road noise and create a quiet environment in your ride. Pipeman's Dampening Mat is easy to install and will improve your bass.



**12" x 24"**

**PERFECT FOR DOORS**

**IS-DT101224**

**SOUND DAMPENING MAT BULK PACKAGE TRUNK KIT**

- Damping Mat Bulk Package
- Included Nine (10) / 12" x 24" sheets
- 2.2mm thick
- Pure butyl
- Handles 40lb / sq inch
- Forget about unwanted road noise and create a quiet environment in your ride. Pipeman's Dampening Mat is easy to install and will improve your bass.



**12" x 24"**

**PERFECT FOR TRUNKS**

**IS-DS21012**

**SOUND DAMPENING MAT BULK PACKAGE SPEAKER KIT**

- Damping Mat Bulk Package
- Included Nine (9) / 10" x 12" sheets
- 2.2mm thick
- Pure butyl
- Handles 40lb / sq inch
- Forget about unwanted road noise and create a quiet environment in your ride. Pipeman's Dampening Mat is easy to install and will improve your bass.



**10" x 12"**

**PERFECT FOR SPEAKERS**

**IS-160**

**GROUND LOOP ISOLATOR**

- Eliminate the electrical noise and hum caused by ground loops with this ground loop isolator. Gold plated connectors enhance performance and resist corrosion.
- 2-CH Signal Output
- Signal Noise Eliminator
- 16 Amp

**16 AMP**



**IS-210**

**GROUND LOOP ISOLATOR**

- Eliminate the electrical noise and hum caused by ground loops with this ground loop isolator. Gold plated connectors enhance performance and resist corrosion.
- 2-CH Signal Output
- Signal Noise Eliminator
- 21 Amp

**21 AMP**



**IS-NR35**

**LINE OUTPUT CONVERTER**

- When adding a amplifier to a OEM stereo the line out converter converts a speaker-level output signal into an RCA preamp-level signal that most amplifiers need.
- High/Low Level Converter
- Signal Noise Eliminator
- 2-CH Signal Outputs



**IS-NR100**

**LINE OUTPUT CONVERTER**

- When adding a amplifier to a OEM stereo the line out converter converts a speaker-level output signal into an RCA preamp-level signal that most amplifiers need.
- High/Low Level Converter
- Signal Noise Eliminator
- 2-CH Signal Outputs
- Output Level Adjustable



**IS-AKNOB-1**

**UNIVERSAL REMOTE RCA GAIN CONTROL**

- This remote amplifier level control is used to adjust an amplifier's power level from a dashboard location. It adds sub-woofer lever controls or balances a multiple amplifier installation. Range is +/- 8 dB. Mount it in or under the dash.



**IS-POPI0**

**POP STOPPER**

- Time Delay Circuit Eliminates "Turn-On Pops"
- Time Delay Circuit Eliminates "Turn-Off Pops"



**IS-RM200**

**HI/LO CONVERTER W/REMOTE TURN ON**

- Line Output Converter w/ Remote turn ON
- Gold Female RCA Output
- Adjustable Line Output Converter
- Converts from 10 to 25 Watts per Channel to Pre-Amp Output
- Remote Turn ON Circuit



**IS-NR12**

**NOISE SUPPRESSOR**

- 10 Amp
- Eliminates Engine & Alternator Noise
- Car Audio, Marine, CB and other 12V Applications. This power line noise suppressor is designed to eliminate the noise in power line and let the car stereo or CB perform at its optimum



**PROW-2002**

**UNIVERSAL POWER WINDOW KIT (2 WINDOWS)**

- Complete Kit to Convert 2 Windows to Full Power
- Universal for All Automobiles
- Converts 2 Manual Windows to Power Window
- Perfectly Suited for any Type of Door, Front or Rear
- Power Window System is Installed Behind the Door Panel
- Does not Change the Exterior Design of the Door Panel
- Power Window Motors are Extremely Quiet
- Cuprum Bearing
- PDM Plastic Gear Wheel

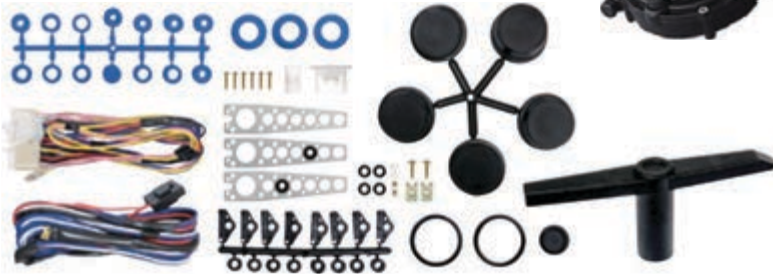

**PROW-4004**

**UNIVERSAL POWER WINDOW KIT (4 WINDOWS)**

- Complete Kit to Convert 4 Windows to Full Power
- Universal for All Automobiles
- Converts 4 Manual Windows to Power Window
- Perfectly Suited for any Type of Door, Front or Rear
- Power Window System is Installed Behind the Door Panel
- Does not Change the Exterior Design of the Door Panel
- Power Window Motors are Extremely Quiet
- Cuprum Bearing
- PDM Plastic Gear Wheel

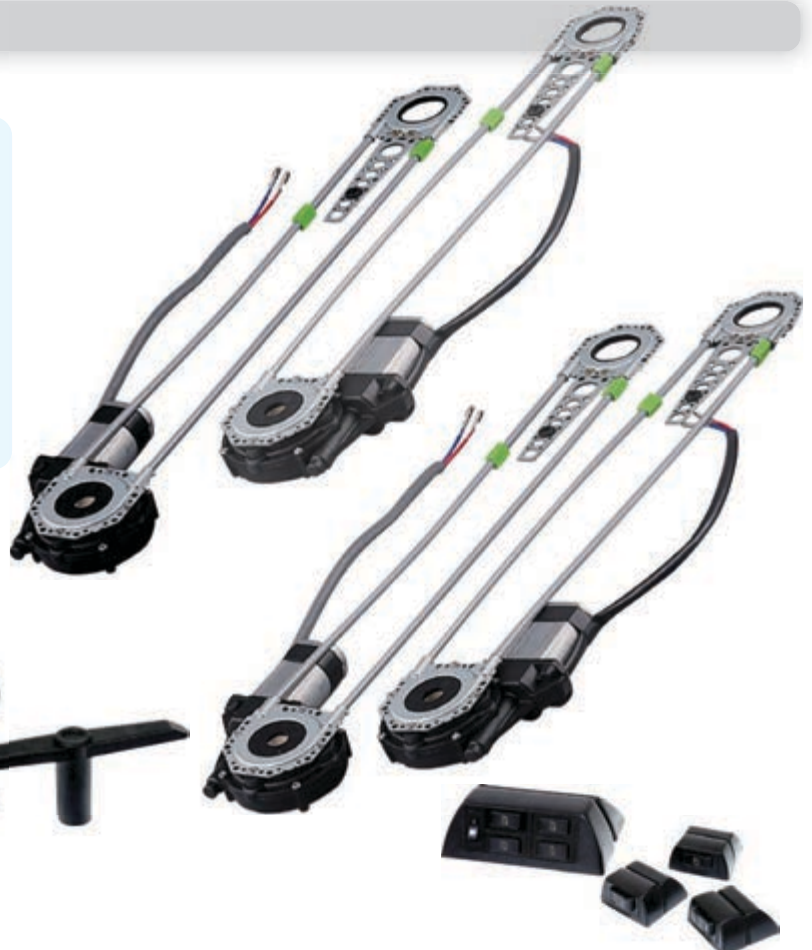



**EWD-151**

**ILLUMINATED CAR WINDOW SWITCH**

- 12V 24V
- 5A-15A
- Contact Resistance: 50 mΩ max
- Insulation Resistance: 500VDC 100mΩ min
- Dielectric Strength: 1500VAC, 1 minute
- Operating Temperature: -25°C~ +85°C
- Electrical Life: 10000 Cycles
- 5 Pins

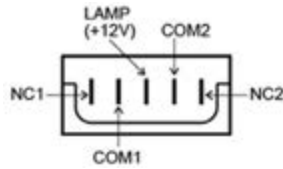

**EWD-153**

**ILLUMINATED CAR WINDOW SWITCH**

- 12V 24V
- 5A-15A
- Contact Resistance: 50 mΩ max
- Insulation Resistance: 500VDC 100mΩ min
- Dielectric Strength: 1500VAC, 1 minute
- Operating Temperature: -25°C~ +85°C
- Electrical Life: 10000 Cycles
- 5 Pins

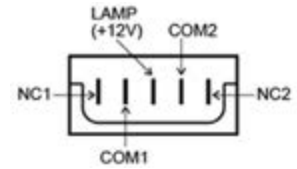

**EWD-155**

**CAR WINDOW SWITCH**

- 12V 24V
- 5A-15A
- Contact Resistance: 50 mΩ max
- Insulation Resistance: 500VDC 100mΩ min
- Dielectric Strength: 1500VAC, 1 minute
- Operating Temperature: -25°C~ +85°C
- Electrical Life: 10000 Cycles
- 6 Pins

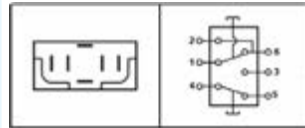

**EWD-157**

**CAR WINDOW SWITCH**

- 12V 24V
- 5A-15A
- Contact Resistance: 50 mΩ max
- Insulation Resistance: 500VDC 100mΩ min
- Dielectric Strength: 1500VAC, 1 minute
- Operating Temperature: -25°C~ +85°C
- Electrical Life: 10000 Cycles
- 6 Pins

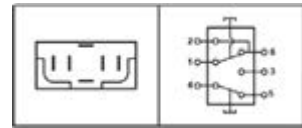

**IS-BARST-8**

**8 POLE CONNECTION BARRIER STRIP**

- Double row screw terminals with barriers
- Easy to connect screw terminals, wire 22-12 ga
- Tin-plated brass terminals, nickel-plated steel screws
- Used in for industrial, electrical, electronic, and automotive projects



**IS-BARST-12**

**12 POLE CONNECTION BARRIER STRIP**

- Double row screw terminals with barriers
- Easy to connect screw terminals, wire 22-12 ga
- Tin-plated brass terminals, nickel-plated steel screws
- Used in for industrial, electrical, electronic, and automotive projects



**DOOR LOCKS**

**IS-CDLS-05M**

**5 WIRE CAR DOOR CENTRAL LOCK**

- 5 Wire Gun Type Actuator
- 360-Degree Rotation Head for Easy Installation
- Working Force:  $\geq 2.5\text{Kg}$
- Working Stroke: 19mm
- Working Life > 100000 Times
- Strong Iron Back Strap
- Iron Fixed Block
- Pull Rod



**IS-CDLS-10R**

**2 WIRE CAR DOOR CENTRAL LOCK**

- 2 Wire Gun Type Actuator
- 360-Degree Rotation Head for Easy Installation
- Working Force  $\geq 2.5\text{Kg}$
- Working Stroke: 19mm
- Working Life > 100000 Times
- Strong Iron Back Strap
- Iron Fixed Block
- Pull Rod



**IS-CDLS-40R**

**CENTRAL DOOR LOCKING SYSTEM**

- Applicable for all Cars(4 Door) and can be Connected with Remote Controller and Alarm Security
- (1) 5 Wire Gun Type Actuator
- (3) 2 Wire Gun Type Actuator
- 360-Degree Rotation Head for Easy Installation
- Working Force  $\geq 2.5\text{Kg}$
- Working Stroke: 19mm
- Working Life > 100000 Times
- Strong Iron back Strap
- Iron Fixed Block
- Pull Rod

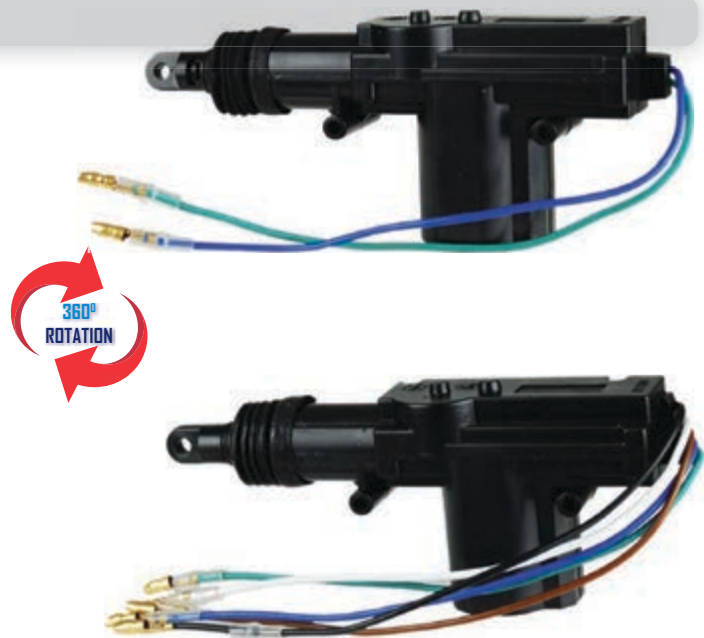

**12v - 10A**  
**OPERATING VOLTAGE**  
**& CURRENT**

**NA-1500**

**PILLAR SIDE MOUNT  
ANTENNA**

- 3 Sections
- Extends to 47.2"
- Cable: 50"
- Fits Most Nissan and Toyota Pick-Up Trucks
- Chrome Finish

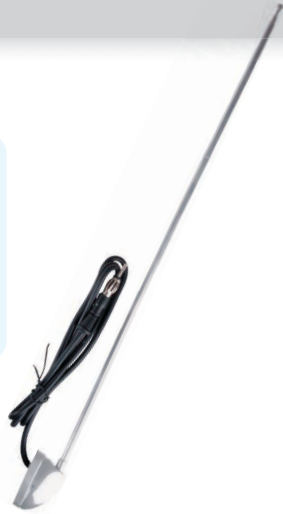

**NA-1500B**

**PILLAR SIDE MOUNT  
ANTENNA**

- 3 Sections
- Extends to 48"
- Cable: 48"
- Fits Most Cars
- Black Finish

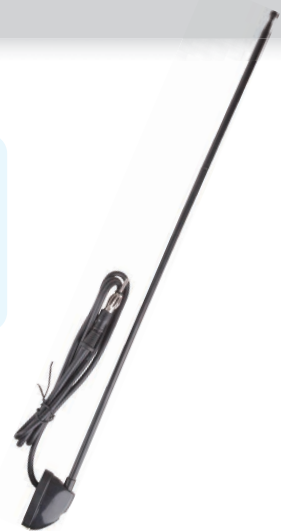

**NA-1517L**

**PILLAR SIDE MOUNT  
ANTENNA**

- 3 Sections
- Extends to 48"
- Cable: 48"
- Fits Toyota Corolla ('78-'83), Tercel ('80-'82), and Mazda GLC ('76-'80)
- Chrome Finish

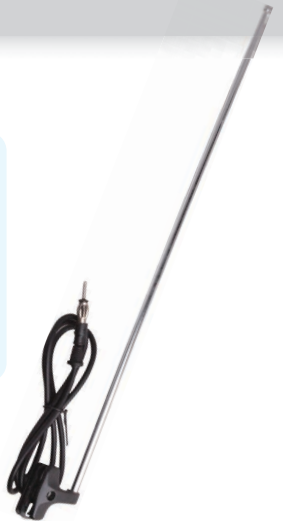

**NA-1599**

**UNIVERSAL SIDE MOUNT  
ANTENNA**

- Universal Side Mount
- Detachable Mast
- 1 Section
- Extends to 31"
- Cable: 72"
- Chrome Finish

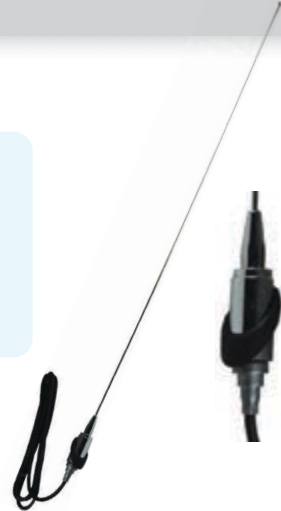

**NA-1502**

**FRONT/REAR FENDER/  
ROOF MOUNT ANTENNA**

- 3 Sections
- Extends to 47"
- Cable: 54"
- Fits Most Cars
- Flexible Spring and Deluxe Ball Base
- Chrome Finish



**NA-1514**

**NARROW FENDER  
MOUNT ANTENNA**

- 4 Sections
- Extends to 39"
- Cable: 48"
- Fits VW Beetle, Bus and Transporter Audi Avant, Citroen CX, Peugeot 104/204/304/404, Renault 12, Toyota Starlet
- 52° Fixed Angle
- Black Finish



**ANTENNAS**

**NA-1508**

**FRONT/REAR FENDER/  
ROOF MOUNT ANTENNA**

- 1 Section
- Extends to 17"
- Cable: 54"
- Fits Most Cars
- Swivel Ball Base 180° Adjustable Angle



**NA-1524**

**UNIVERSAL FRONT OR  
REAR DECK ANTENNA**

- 1 Section Spring Whip
- Extends to 31"
- Cable: 54"



**NA-523**

**UNIVERSAL ROOF/REAR  
DECK MOUNT ANTENNA**

- 1 Section Black Fiberglass Mast
- Mast Length 510mm (20")
- Cable Length 2030mm (80")
- Alloy Ball Base Adjustable Angle 90°
- Side Mount

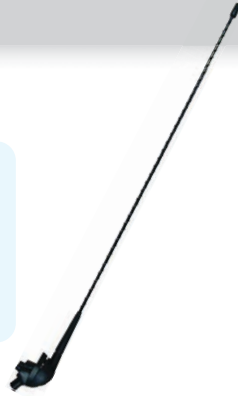

**NA-1533**

**UNIVERSAL ANTENNA**

- Fits Toyota Corolla ('93 & Up)
- 1 Section
- Extends to 31"
- Cable: 82"



**NA-1553**

**UNIVERSAL ANTENNA**

- Fits Nissan, Datsun Pick-Up ('89 & up)
- 1 Section
- Extends to 31"
- Cable: 54"

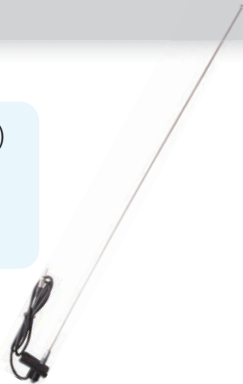

**NA-5000**

**UNIVERSAL STAINLESS  
STEEL ANTENNA**

- 4 Sections
- Side Key Lock
- 0 ~ 30° Mounting Angle Big Fit-Head
- Extends to 39.4"
- Cable: 50"



**NA-1549**

**AMPLIFIED WINDSCREEN  
CAR ANTENNA**

- High Sensitivity
- AM/FM Reception
- 1 Section
- 13.5" length
- Cable: 80"



**NA-1659**

**AMPLIFIED WINDSCREEN  
CAR ANTENNA**

- High Sensitivity
- AM/FM Reception
- 1 Section
- 11.5" length
- Cable: 80"



**IS-NE22**

**UNIVERSAL ROOF, FRONT,  
OR REAR MOUNT ANTENNA**

- 1 Section Flexible Rubber Mast
- Swivel Ball Base 180° Adjustable Angle
- Extends to 16"
- Cable: 54"

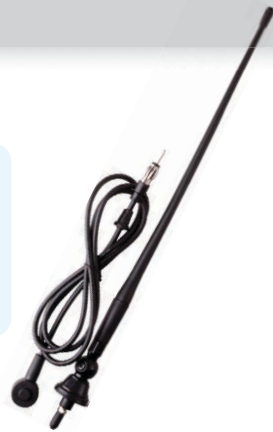

**NA-1560**

**STICK-ON ROOF MOUNT  
ANTENNA**

- 1 Section Fiberglass Mast
- Extends to 16"



**NA-25215**

**SINGLE MIRROR MOUNT  
ANTENNA**

- 1 Section Fiberglass Mount
- Extends to 48"
- Cable: 140"
- Frequency: 27MHz



**NA-26280**

**MAGNETIC MOUNT CAR  
ANTENNA**

- Base Loaded
- 1 Section
- Extends to 15"
- Cable: 120"
- Frequency: 27MHz



**NA-50FL**

**FENDER MOUNT ANTENNA**

- 5 Sections
- Material: SUS304
- Working Principle: PCB Control
- Coaxial Cable: 75 Ohms
- Length: 1500mm (59")
- Rod Length: 800mm (31.5")
- Connector: Motorola Plug
- 0-30° Adjustable Mounting Base



**NA-90FL**

**FENDER MOUNT ANTENNA**

- 5 Sections
- Material: SUS304
- Working Principle: PCB Control
- Coaxial Cable: 75 Ohms
- Length: 1500mm (59")
- Rod Length: 1000mm (39")
- Connector: Motorola Plug
- 0-30° Adjustable Mounting Base



**NA-1555UN**

**ALUMINUM ANTENNA MAST**

- Made of High Quality Light-Weight Aluminum Alloy
- Stylish Carbon Fiber Design
- Replaces most Stock Mast/Whip Antenna Styles
- 4.7" length



**NA-1546ER**

**ANTENNA WITH BUILT-IN ANTENNA**

- Roof Mount
- 5M Extension Cable
- Perfect Fit for European Models



**NA-1544RF**

**SHARK FIN ANTENNA WITH BUILT-IN AMPLIFIER**

- Roof Mount
- 5M Extension Cable
- Perfect Fit for European Models



**IS-CR16**

**ANTENNA ADAPTER FOR CHRYSLER**

- Simply plug and play installation, no cutting required
- Adapts factory antenna plug into aftermarket style
- Ideal for any aftermarket radio
- Direct OEM fit connection



**VW-16**

**FACTORY ANTENNA TO AFTER-MARKET RADIO ADAPTERS FOR VOLKSWAGEN**

- Simply plug and play installation, no cutting required
- Adapts factory antenna plug into aftermarket style
- Ideal for any aftermarket radio
- Direct OEM fit connection

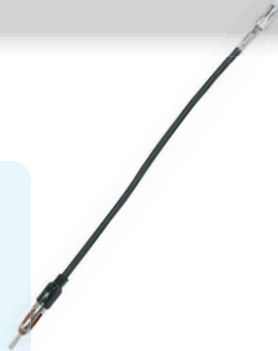

**NA-SPAD-C**

**TRUCK SHOCK SPRING ANTENNA ADAPTER**

- The Semi-Flexible Mast Helps withstand Bracing Winds
- Sold Individually



**IS-VW-16P**

**ANTENNA ADAPTER**

- Plug for Volkswagen



**EA-1.5 (1.5")**

**EA-3 (3")**

**EA-6 (6")**

**EA-12 (12")**

**ANTENNA EXTENSION CORD**

- Extension Cord



**EU-22**

**ANTENNA ADAPTER FOR BMW AND VOLKSWAGEN**

- Antenna Adapter for BMW and Volkswagen 2002-2008
- Factory Radio to After-Market Antenna Adapters for European



**IS-GM16**

**FACTORY ANTENNA TO AFTER-MARKET RADIO ADAPTERS FOR GM**

- Simply plug and play installation, no cutting required
- Adapts factory antenna plug into aftermarket style
- Ideal for any aftermarket radio
- Direct OEM fit connection



**EA-1**

**STANDARD MALE ANTENNA PLUG**

- Extend, adapt or split your mast antenna lead with these adapters. These fit a standard Motorola car antenna connection.



**IS-NI16**

**ANTENNA ADAPTER FOR NISSAN**

- This antenna adapter lets you connect an aftermarket receiver to the factory antenna cable in select 2006 and later Nissan models



**IS-TY11**

**ANTENNA ADAPTER FOR TOYOTA**

- This antenna adapter lets you connect an aftermarket receiver to the factory antenna cable in select 2009-up Toyota vehicles. The adapter has a standard male Motorola plug on one end and a female molex connector on the other



**IS-SB10**

**ANTENNA ADAPTER FOR SUBARU MODELS**

- This antenna adapter lets you connect an aftermarket receiver to the factory antenna cable in select 2006-up Nissan vehicles. The adapter has a Subaru female plug on one end and a Motorola male plug on the other



**IS-HD11**

**ANTENNA ADAPTER FOR 2015 HONDA MODELS**

- This antenna adapter lets you connect an aftermarket receiver to the factory antenna cable in select 2015 Honda models



**IS-HD10**

**ANTENNA ADAPTER FOR HONDA MODELS 2010 AND LATER**

- This antenna adapter lets you connect an aftermarket receiver to the factory antenna cable in select 2015 Honda models



**IS-EXPI4-TYKT**

**14MHZ BAND EXPANDER FOR 2014 AND LATER TOYOTA MODELS**

- Supplied with factory connector for a quick plug and play
- All our Band Expanders contain a by-pass within their circuitry which allows current to pass through the FM Band Expander to the antenna amplifier fitted at the base of antenna

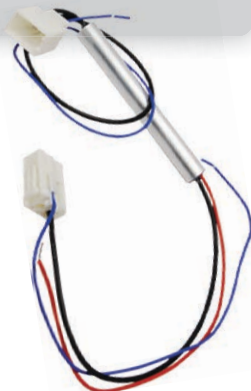

**IS-EXPI05N**

**14MHZ BAND EXPANDER FOR 2007 AND LATER NISSAN MODELS**

- Supplied with factory connector for a quick plug and play
- All our Band Expanders contain a by-pass within their circuitry which allows current to pass through the FM Band Expander to the antenna amplifier fitted at the base of antenna



**IS-EXP-MOT**

**BAND EXPANDER**

- FM band 88-108 MHz crystal 19 MHz band expander



**ECSW-USB15**

**AUX AUDIO INPUT**

- Aux Audio Input with 2.1A USB Charger



**IS-EXPI4-HDN**

**BAND EXPANDER**

- FM Band 88-108MHz
- CRYSTAL 19MHz

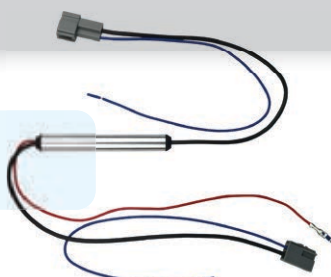

**617**

**HEAVY DUTY ALARM SWITCH**

- Universal Pin Switch that Will Work for Most Brand of Car Alarms



**618**

**ADJUSTABLE METAL PIN SWITCH**

- Especially Good for Car Bonnets, this Heavy Duty Pin Switch is Nickel-Plated for Protection from Corrosion in Hostile Environments

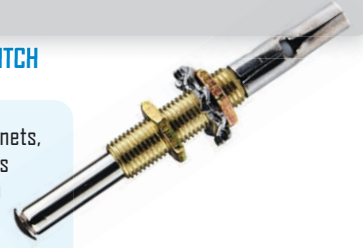

**621**

**CUTTABLE PLASTIC PIN SWITCH**

- Plastic PIN switch



**AQK-P14FM**

**MALE TO FEMALE TERMINAL**

- 14 Gauge
- 2'
- Security Lock



**PRO-1000**

**RELAY SOCKET**

- With Diode
- For Alarm Installations
- Starter Kill Prewired



**PRO-1020**

**RELAY SOCKET**

- Dual Sockets
- For Wiring Door Lock Actuators



**30ARF**

**RELAY**

- 30A ATC inline fuse
- 12V DC
- 30A/40A



**40ARB**

**RELAY**

- 40 A
- 25VDC
- DC 12V



**80-ARB**

**RELAY**

- 80 A/14V DC
- 60A/14VDC
- DC 12V



**40AMP**

**RELAY**

- 40A/14V DC
- 30A/14V DC
- DC 12V



**4DISR**

**RELAY**

- NO:40 A
- NC:30 A
- DC 12V



**4DISR-24V**

**RELAY**

- Current 40A
- DC 24V
- 24 coil voltage
- 5 Pin
- This relay has a universal application and can be used in automotive setups, car sound systems, or security





**IS-1005SK**

**5 WIRE RELAY SOCKET**

- Connection Type: Pigtail
- Length: 12"
- Gauge: Red 16AWG  
Blue 16AWG  
Yellow 16AWG  
White 18AWG  
Black 18AWG
- Quantity: 10



Compatible with  
40ARB, 30ARF, 40AMP,  
40ISR, 40ISR-24V Relays  
**(NOT INCLUDED)**

Pre-wired relay socket for use with 12V DC Bosch type five terminal relays. Suitable for use with high power LED Off Road Bars, AUX lights, Work Lights and other custom applications.

**IS-1805SK**

**STACKABLE 5 WIRE RELAY SOCKET**

- Cable Length: 135mm/5.4"
- Rated Current: 80A
- Rated Voltage: DC 12V/24V
- Cable Dia.: 2.5mm/0.1", 5mm/0.2"
- Size (Not Including Wire): 1.4" x 1.4" x 1.1" (L\*W\*H)
- Pin: 5 Pins 5 Wires



Compatible with 80ARB Relay  
**(NOT INCLUDED)**

Hundreds of uses include starter kills, domelight supervision, trunk release, polarity change, power door lock/actuator control, change a low current output to high current, add ignition/accessory outputs, control motors/ other electronics, It is also suitable for automobiles and used for control, alarms, horn, headlight and more. Long Life expectancy, more than 10,000 cycles.

**40AWP-H**

**40A WATERPROOF 5 PIN RELAY SWITCH HARNESS SET**

- Waterproof: IP67
- Rated Load: 40A/14VDC
- Wire Length: 12 cm
- Contact Wire: AWG12



**PRO-1205-CER**

**CERAMIC RELAY SOCKET**

- 16AWG wire suit for 4 pins relay ceramic relay socket, 5 pins auto relay holder
- Excellent heat corrosion resistance tin widing copper wires
- Easy DIY installation, no need tools
- Can be used to creat extra light outlet
- Fit for Relay: 40A, 30ARF, 40AMP, 40ISR, and 40ISR-24V. 4 Pins/5 pins
- Length of cable: 14.5 cm / 5.7 inch
- Application temperature : 105° C / 221° F
- Voltage rated: 12-32V

Ceramic material socket with extremely high heat resistant. Plug and work directly, no need to cut anything. Great for adding car stereo, alarm system, remote start, fog lights, undercar lighting, turn on domelight, shared door handle, truck release, reverse polarity, door locks and more.



**WH-PIONEER01**

**PIONEER RADIO REPLACEMENT  
WIRING HARNESS**

- 14 Gauge
- 2'
- Security Lock



**WH-PIONEER11**

**WIRING HARNESS**

- Pioneer Radio replacement wiring harness



**WH-TOY 8702**

**WIRING HARNESS FOR  
TOYOTA 1987-2002 MODELS**

- 14 Gauge
- 2'
- Security Lock



**ISO-002**

**WIRING HARNESS**

- Wiring harness for Volkswagen models



**WH-HON 0208**

**WIRING HARNESS**

- Wiring harness for Honda 2002 and later models



**WH-NIS 0210**

**WIRING HARNESS**

- Wiring harness for Nissan 2002 and later models



**WH-NIS 9502**

**WIRING HARNESS**

- Wiring harness for Nissan 1995 - 2002 and later models



**WH-NIS 0710**

**WIRING HARNESS**

- Wiring harness for Nissan 2007 and later models

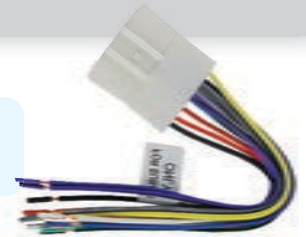

**WH-HYN 0210**

**WIRING HARNESS**

- Wiring harness for Hyundai 2002 and later models



**WH-JVC09**

**WIRING HARNESS**

- Wiring harness for JVC models



**WH-JVC16P**

**WIRING HARNESS**

- Wiring harness for JVC models



**WH-KENWOOD16P**

**WIRING HARNESS**

- Wiring harness for Kenwood models



**WH-MAZ 0110**

**WIRING HARNESS**

- Wiring harness for Mazda 2001 and later models



**WH-MIT 9410**

**WIRING HARNESS**

- Wiring harness for Mitsubishi 1994 and later models



**WH-VW-8602**

**WIRING HARNESS**

- Wiring harness for Volkswagen 1986 - 2002 models



**SC-104**

**CASSETTE ADAPTER**

- CD/MD/MP3 Cassette Adapter



**IS-MVA8**

**8-CHANNEL VIDEO AMPLIFIER**

- Each Channel Output can be Independently Adjusted
- Shielded Metal Housing
- Power Supply Voltage: 12V
- Output Impedance: 75Ω
- Video Level: Input: 1.0Vp-p / Output: 0.5-1.5Vp-p



**8 Channel VIDEO OUTPUT**

**12 Volts POWER SUPPLY**

**IS-AMP-220**

**HIFI STEREO AUDIO AMPLIFIER**

- Input: DC 12V, 5A
- Power: 20W max, 10W RMS
- Speaker Impedance: 4~16Ω
- Frequency: 20Hz~20KHz



**IS-AMP-221BT**

**HIGH POWER AMPLIFIER**

- USB, SD card input, FM Stereo radio
- MP3 audio format play
- External audio input
- GH-Power BTL output
- DC 12V input
- FM frequency range: 87.5MHz-108.0MHz
- Frequency response: 20Hz-20kHz
- Output power: RMS 20W+20W 1KHz

Harmonic distortion: <0.05% 4W 1KHz  
SNR: 85dB  
High control: 12dB ± 10KHz  
Bass control: 12dB ± 100Hz  
The signal level: 220MV 47K



**80 Watts**

**MAX POWER**

**LED LIGHT BARS**



ALL NL-LBR LED LIGHT BARS INCLUDE MOUNTING & INSTALLATION HARDWARE

**NL-LBC-352-288W**  
**52" CURVED LED LIGHT BAR**

- Beam: Spot-Flood Combo
- Operating Voltage: DC 10-30V
- Power: 288W (96 x 3W/pcs high intensity LEDs)
- Color Temperature: 6000K
- Lumen: 22000LM
- Lifespan: >30,000 hours
- Waterproof Rate: IP 67
- Lens Material: PC
- Housing Material: Diecast Aluminum
- Dimensions (LxWxH): 52" x 3.3" x 3"



**52 In**

**288 Watts**



**NL-LBC-354-300W**  
**54" CURVED LED LIGHT BAR**

- Beam: Spot-Flood Combo
- Operating Voltage: DC 10-30V
- Power: 300W (100 x 3W/pcs high intensity LEDs)
- Color Temperature: 6000K
- Lumen: 22000LM
- Lifespan: >30,000 hours
- Waterproof Rate: IP 67
- Lens Material: PC
- Housing Material: Diecast Aluminum
- Dimensions (LxWxH): 54" x 3.3" x 3"

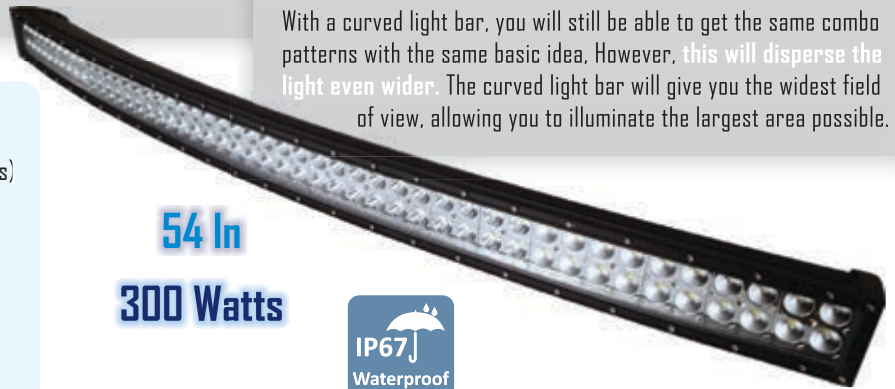

With a curved light bar, you will still be able to get the same combo patterns with the same basic idea. However, this will disperse the light even wider. The curved light bar will give you the widest field of view, allowing you to illuminate the largest area possible.

**54 In**

**300 Watts**



**NL-LBR353-288W**  
**53" LED LIGHT BAR**

- Beam: Spot-Flood Combo
- Operating Voltage: DC 10-30V
- Power: 288W (96 x 3W/pcs high intensity LEDs)
- Color Temperature: 6000K
- Lumen: 22000LM
- Lifespan: >30,000 hours
- Waterproof Rate: IP 67
- Lens Material: PC
- Housing Material: Diecast Aluminum
- Dimensions (LxWxH): 53" x 3.3" x 3"



All of our NL-LBR Led Light Bars can be used on any Vehicle, ATV, Boat, Tractor or other heavy equipment. It uses the latest LED Technology, supplying superior light output and optimum energy efficiency.

**53 In**

**288 Watts**



**NL-LBR355-300W**  
**55" LED LIGHT BAR**

- Beam: Spot-Flood Combo
- Operating Voltage: DC 10-30V
- Power: 300W (100 x 3W/pcs high intensity LEDs)
- Color Temperature: 6000K
- Lumen: 22000LM
- Lifespan: >30,000 hours
- Waterproof Rate: IP 67
- Lens Material: PC
- Housing Material: Diecast Aluminum
- Dimensions (LxWxH): 55" x 3.3" x 3"



**55 In**

**300 Watts**



**LED LIGHT BARS**

**NL-LBR325-120W**

**25" LED LIGHT BAR**

- Beam: Spot-Flood Combo
- Operating Voltage: DC 10-30V
- Power: 120W (40 x 3W/pcs high intensity LEDs)
- Color Temperature: 6000K
- Lumen: 22000LM
- Lifespan: >30,000 hours
- Waterproof Rate: IP 67
- Lens Material: PC
- Housing Material: Diecast Aluminum
- Dimensions (LxWxH): 25" x 3.3" x 3"



**25 In**  
**120 Watts**



**NL-LBR333-180W**

**33" LED LIGHT BAR**

- Beam: Spot-Flood Combo
- Operating Voltage: DC 10-30V
- Power: 180W (60 x 3W/pcs high intensity LEDs)
- Color Temperature: 6000K
- Lumen: 22000LM
- Lifespan: >30,000 hours
- Waterproof Rate: IP 67
- Lens Material: PC
- Housing Material: Diecast Aluminum
- Dimensions (LxWxH): 33" x 3.3" x 3"



**33 In**  
**180 Watts**



**NL-LBR317-72W**

**17" LED LIGHT BAR**

- Beam: Spot-Flood Combo
- Operating Voltage: DC 10-30V
- Power: 288W (96 x 3W/pcs high intensity LEDs)
- Color Temperature: 6000K
- Lumen: 22000LM
- Lifespan: >30,000 hours
- Waterproof Rate: IP 67
- Lens Material: PC
- Housing Material: Diecast Aluminum
- Dimensions (LxWxH): 53" x 3.3" x 3"



**17 In**  
**72 Watts**



**ALL NL-LBR LED LIGHT BARS INCLUDE MOUNTING & INSTALLATION HARDWARE**



**NL-LBS326-72W**

**26" LED LIGHT BAR**

- Voltage: DC 10-30V
- Power: 72W (24pcs x 3W high intensity LEDs)
- Luminous Flux: 1530 LM
- Color Temperature: 6000K
- Service Life: 50000h
- Waterproof Rate: IP67
- Material: Aluminum alloy
- Dimensions (LxWxH): 26" x 1.8" x 1.2"
- Mounting Hardware Included



**26 In**  
**72 Watts**



**NL-LBMX382-25W**

**8" TRIPLE ROW 4D OFF-ROAD LED LIGHT**

- Beam: Spot
- Voltage: 10 - 30V DC
- Waterproof: IP67
- LED Chips: 0.9W Epistar
- Color Temperature: 6000K
- Material: Diecast Aluminum Housing
- Lens Material: PC Lens
- Mounting Bracket: Aluminum Firm Bracket and Stainless Steel Screws
- Span Life: >30,000 Hours
- Dimensions (LxWxH): 8" x 3.3" x 3"
- Mounting Hardware Included



**8 In**  
**25 Watts**

**NL-LBS36-18W**

**6" 18W LED MINI LIGHT BAR**

**BEST SELLER**

- Voltage: DC 10-30V
- Power: 18W
- 6 Pcs x 3W High Intensity LEDs
- Luminous Flux: 1530 LM
- Color Temperature: 6000K
- Service Life: 50000h
- Waterproof Rate: IP67
- Material: Aluminum Alloy
- Dimensions (LxWxH): 6" x 1.7" x 1.8"
- Mounting Hardware Included

This high quality mini light bar has 6 CREE LED bulbs with intense brightness up to 1530 lumens and is housed in diecast Aluminum



**6 In**  
**18 Watts**



**NL-LBSQ-33-10W**

**3" 10W LED SPOT LIGHT**

- Power: 10W
- Voltage: 10-30V DC
- Waterproof Rate: IP 67
- LED Chips: 2.5W Cree
- Color Temperature: 6000K
- Lumen: 880 LM
- Beam: Spot / Flood
- Span Life: 50000 Hours
- Dimensions (LxWxH): 3.25" x 3" x 3"
- Mounting Hardware Included

This spot Light gives you wide-area coverage. Designed for rigorous off-road use. The whole unit is IP67 rated to be dust-tight and withstand brief submersion. The spot light is easy to install with the supplied bracket.



**10 Watts**



**NL-LBSQ874D-10W**

**3" 10W LED SPOT LIGHT WITH 4D POLYCARBONATE LENS**

- Power: 10W
- Voltage: 10-30V DC
- Waterproof Rrate: IP 67
- LED Chips: 2.5W Cree
- Color Temperature: 6000K
- Lumen: 880 LM
- Beam: Spot / Flood
- Span Life: 50000 Hours
- Dimensions (LxWxH): 3.25" x 3" x 3"
- Mounting Hardware Included

This spot Light uses a 4D PC lens that concentrates the light beams and creates an extremely powerful light visible in daytime



**10 Watts**



**4D**  
**Polycarbonate**  
**Lens**

**NL-LBOV-43-20W**

**20W LED WORK LIGHT**

- Power: 20W
- Voltage: 9-32V
- Waterproof Rate: IP67
- Color Temperature: 6500K
- Lumen: 1400LM
- Beam: Spot/Flood
- Dimensions: 2 1/2" x 4"

**20 Watts**



**NL-LB303-18W**

**3" 12W CREE LED LIGHT BAR**

- Description: Cree LED Light Bar
- Operation Voltage: 10-30V DC
- LED Module: 3W/pcs Cree LEDs
- LENS Material: Tempered Glass
- Beam: Spot, Flood, Combo
- Waterproof Level: IP67
- Color Temp.: 6000K~6500K
- Housing Material: Aluminum
- Life Span: >30,000 hours
- Sold in Pairs

**3 In**  
**12 Watts**



Super bright spot beam with High quality LED chips emit bright concentrated white light. The pod can be adjusted to about 45 degrees, which makes changing direction of light beam easier. this product is universal and will fit all vehicles.

**NL-LBRO-07-51W**

**51W WORK LIGHT**

- Power: 51W
- Voltage: 9-32V
- Waterproof Rate: IP67
- Color temperature: 6500K
- Lumen: 4000LM
- Beam: Spot/Flood Epistar
- Dimensions: 7" x 2.5" x 7.5" (LxWxH)

**51 Watts**



Very bright rays flood the road or area making it perfect for off-roading or as a worklight. With a tough, aluminum cover, and tough shatterproof PC durable to withstand extreme condition.

**NL-LBSQ-14-27W**

**4" 27W SQUARE LED FOG LIGHT**

- LED Light Color: White
- Voltage: 9V-36V
- Power: 27W (9pcs x 3W high intensity LEDs)
- Luminous Flux: 1980 LM
- Color temperature: 6000K
- Service Life: 30000h
- Material: Aluminum
- Bracket: Stainless steel bracket
- Waterproof Rate: IP67
- Size: 108 x 108 x 35mm / (4.3" x 4.3" x 1.4")
- Mounting Hardware Included

**4 In**  
**27 Watts**



The led flood work light is compatible with almost all Jeeps, 4x4, Trucks, Motorcycles, SUVs, ATVs, Cars, Boats, etc. Many indoor and outdoor uses like Garden Lighting, Backyard Lighting, Back-up Light, Off Road Lighting, Construction Lighting and more.

**NL-LBSQ-15-27W**

**5" 27W SQUARE LED FOG LIGHT**

- LED Light Color: White
- Voltage: DC 10-30V
- Power: 27W (9pcs x 3W high intensity LEDs)
- Luminous Flux: 1800 LM
- Color Temperature: 6000K
- Service Life: 30000h
- Material: Aluminum alloy
- Bracket: Stainless steel bracket
- Waterproof Rate: IP67
- Size: 4.5" x 4.5" x 1.2"
- Mounting Hardware Included

**5 In**  
**27 Watts**



Now more durable than ever with its Grooved heat sink fins extends cooling surface for quick heat elimination, extending this work light's Lifespan over 30,000 hours! It's Instant start, smart system protects this light from damage even if it is connected to the wrong polarity

**NL-LBSTRQ-15-27W**

**5" 27W SQUARE LED FOG LIGHT**

- LED Light Color: White & Yellow (Flashing light)
- Voltage: DC 10-30V
- Power: 27W (9pcs x 3W high intensity LEDs)
- Luminous Flux: 1800 LM
- Color Temperature: 6000K
- Service Life: 30000h
- Material: Aluminum alloy
- Bracket: Stainless steel bracket
- Waterproof Rate: IP67
- Size: (4.5" x 4.5" x 1.8")
- With Amber LED Strobe Effect
- Mounting Hardware Included

**5 In**  
**27 Watts**



**White & Amber LED**

**NL-H-9005-36W**

**SI LED HEADLIGHT-9005**

- Power: 36 Watts per piece
- Voltage: 9-32V (fits 12V/24V vehicles)
- Lumen: 3600 LM
- Ideal for High Beam Reflector headlights
- Easy and click Installation
- Waterproof: IP67
- Secure temperature range up to 6500K
- With LED CSP beam
- Constant brightness output at all times



**NL-H-9006-36W**

**SI LED HEADLIGHT-9006**

- Power: 36 Watts per piece
- Voltage: 9-32V (fits 12V/24V vehicles)
- Lumen: 3600 LM
- Enhanced light efficiency
- Waterproof: IP67
- Easy and click Installation
- Secure temperature range up to 6500K
- With LED CSP beam





**NL-H-9007-36W**

**SI LED HEADLIGHT-9007**

- Power: 36 Watts per piece
- Voltage: 9-32V (fits 12V/24V vehicles)
- Lumen: 3600 LM
- Waterproof: IP67
- Easy one click Installation
- Secure temperature range up to 6500K
- With LED CSP beam



**NL-H-H1-36W**

**H1 LED HEADLIGHT**

- Power: L/36W, H/36W - Voltage: 9V-32V DC
- Working Temperature: -40°C~ +85°C
- LED Type: CSP x 6 PCS (SINGLE BEAM), CSP x 12PCS(DOUBLE BEAM)
- Lumens: 4000LM
- Cooling System: Aviation Aluminum 6063
- Color Temperature: 6000K
- Waterproof: IP67
- Beam Angle: 360°
- Material: Aluminum Alloy
- Lifespan: 50,000hrs



**NL-H-H4-36W**

**H4 LED HEADLIGHT**

- Power: L/36W, H/36W - Voltage: 9V-32V DC
- Working Temperature: -40°C~ +85°C
- LED Type: CSP x 6 PCS (SINGLE BEAM), CSP x 12PCS(DOUBLE BEAM)
- Lumens: 4000LM
- Cooling System: Aviation Aluminum 6063
- Color Temperature: 6000K
- Waterproof: IP67
- Beam Angle: 360°
- Material: Aluminum Alloy
- Lifespan: 50,000hrs



**NL-H-H7-36W**

**H5 LED HEADLIGHT**

- Power: L/36W, H/36W - Voltage: 9V-32V DC
- Working Temperature: -40°C~ +85°C
- LED Type: CSP x 6 PCS (SINGLE BEAM), CSP x 12PCS(DOUBLE BEAM)
- Lumens: 4000LM
- Cooling System: Aviation Aluminum 6063
- Color Temperature: 6000K
- Waterproof: IP67
- Beam Angle: 360°
- Material: Aluminum Alloy
- Lifespan: 50,000hrs



**NL-H-H11-36W**

**H11 LED HEADLIGHT**

- Power: L/36W, H/36W - Voltage: 9V-32V DC
- Working Temperature: -40°C~ +85°C
- LED Type: CSP x 6 PCS (SINGLE BEAM), CSP x 12PCS(DOUBLE BEAM)
- Lumens: 4000LM
- Cooling System: Aviation Aluminum 6063
- Color Temperature: 6000K
- Waterproof: IP67
- Beam Angle: 360°
- Material: Aluminum Alloy
- Lifespan: 50,000hrs



**NL-H-H13-36W**

**H13 LED HEADLIGHT**

- Power: L/36W, H/36W - Voltage: 9V-32V DC
- Working Temperature: -40°C~ +85°C
- LED Type: CSP x 6 PCS (SINGLE BEAM), CSP x 12PCS(DOUBLE BEAM)
- Lumens: 4000LM
- Cooling System: Aviation Aluminum 6063
- Color Temperature: 6000K
- Waterproof: IP67
- Beam Angle: 360°
- Material: Aluminum Alloy
- Lifespan: 50,000hrs



**NL-CAN-H-H4**

**LED HEADLIGHT WITH CANBUS**

- Power: L/36W, H/36W - Voltage: 12V-24V DC
- Working Temperature: -40°C~ +85°C
- LED Type: CSP x 6 PCS (SINGLE BEAM), CSP x 12PCS
- Lumens: 4000LM
- Cooling System: Aviation Aluminum 6063
- Color Temperature: 6000K
- Waterproof: IP67
- Beam Angle: 360°
- Material: Aluminum Alloy
- Lifespan: 50,000hrs



**NEW**

**NL-CAN-H-H7**

**LED HEADLIGHT WITH CANBUS**

- Power: L/36W, H/36W - Voltage: 12V-24V DC
- Working Temperature: -40°C~ +85°C
- LED Type: CSP x 6 PCS (SINGLE BEAM), CSP x 12PCS
- Lumens: 4000LM
- Cooling System: Aviation Aluminum 6063
- Color Temperature: 6000K
- Waterproof: IP67
- Beam Angle: 360°
- Material: Aluminum Alloy
- Lifespan: 50,000hrs



**NEW**

**NL-CAN-H-H11**

**LED HEADLIGHT WITH CANBUS**

- Power: L/36W, H/36W - Voltage: 12V-24V DC
- Working Temperature: -40°C~ +85°C
- LED Type: CSP x 6 PCS (SINGLE BEAM), CSP x 12PCS
- Lumens: 4000LM
- Cooling System: Aviation Aluminum 6063
- Color Temperature: 6000K
- Waterproof: IP67
- Beam Angle: 360°
- Material: Aluminum Alloy
- Lifespan: 50,000hrs



**NEW**

**NL-CAN-H-9005**

**LED HEADLIGHT WITH CANBUS**

- Power: L/36W, H/36W - Voltage: 12V-24V DC
- Working Temperature: -40°C~ +85°C
- LED Type: CSP x 6 PCS (SINGLE BEAM), CSP x 12PCS
- Lumens: 4000LM
- Cooling System: Aviation Aluminum 6063
- Color Temperature: 6000K
- Waterproof: IP67
- Beam Angle: 360°
- Material: Aluminum Alloy
- Lifespan: 50,000hrs



**NEW**

**NL-CAN-H-9006**

**LED HEADLIGHT WITH CANBUS**

- Power: L/36W, H/36W - Voltage: 12V-24V DC
- Working Temperature: -40°C~ +85°C
- LED Type: CSP x 6 PCS (SINGLE BEAM), CSP x 12PCS
- Lumens: 4000LM
- Cooling System: Aviation Aluminum 6063
- Color Temperature: 6000K
- Waterproof: IP67
- Beam Angle: 360°
- Material: Aluminum Alloy
- Lifespan: 50,000hrs



**NEW**

**NL-HL-7243-72W**

**72W LED HEADLIGHT**

- Led Power: 72W
- LED Chip: 24PCS x 3W (Hi/Lo & DRL are Cree 3030)
- With (DRL) Daytime Running Lights
- Waterproof: IP67
- Lens: PMMA
- Beam: Flood \ Spotlight Combo
- Dimensions: 195 x 140 x 70 mm (7.7" x 5.5" x 2.8")

**7 In**  
**72 Watts**



**With (DRL)  
Daytime  
Running Lights**



**NL-LBKT-10**

**LED LIGHT BAR WIRING KIT WITH SWITCH FUSE AND RELAY**

- Universal Wiring Harness Equipped with a Fuse, Relay, and Illuminated ON/OFF Switch.
- Easily Connects any Lighting Accessory to its Power Source by Tapping into the Battery Directly.
- This Wiring Kit is Compatible with any LED, HID, or Halogen Off-Road LightBar, Work Light or Auxiliary Lights
- Perfect for Fog Lights, Work Lights, Spot Lights, Off-Road Driving Light, etc.
- Voltage: 12V
- Current: 40A
- Fuse Ampere Rating: 30A

Universal Wiring Harness with a Fuse, Relay, and Illuminated ON/OFF Switch. This kit allows you to hook up your lights directly to your battery and control it conveniently from the ON/OFF switch.



**Wire Harness Kit**  
**Wiring Diagram**

**NL-LBKT-10**

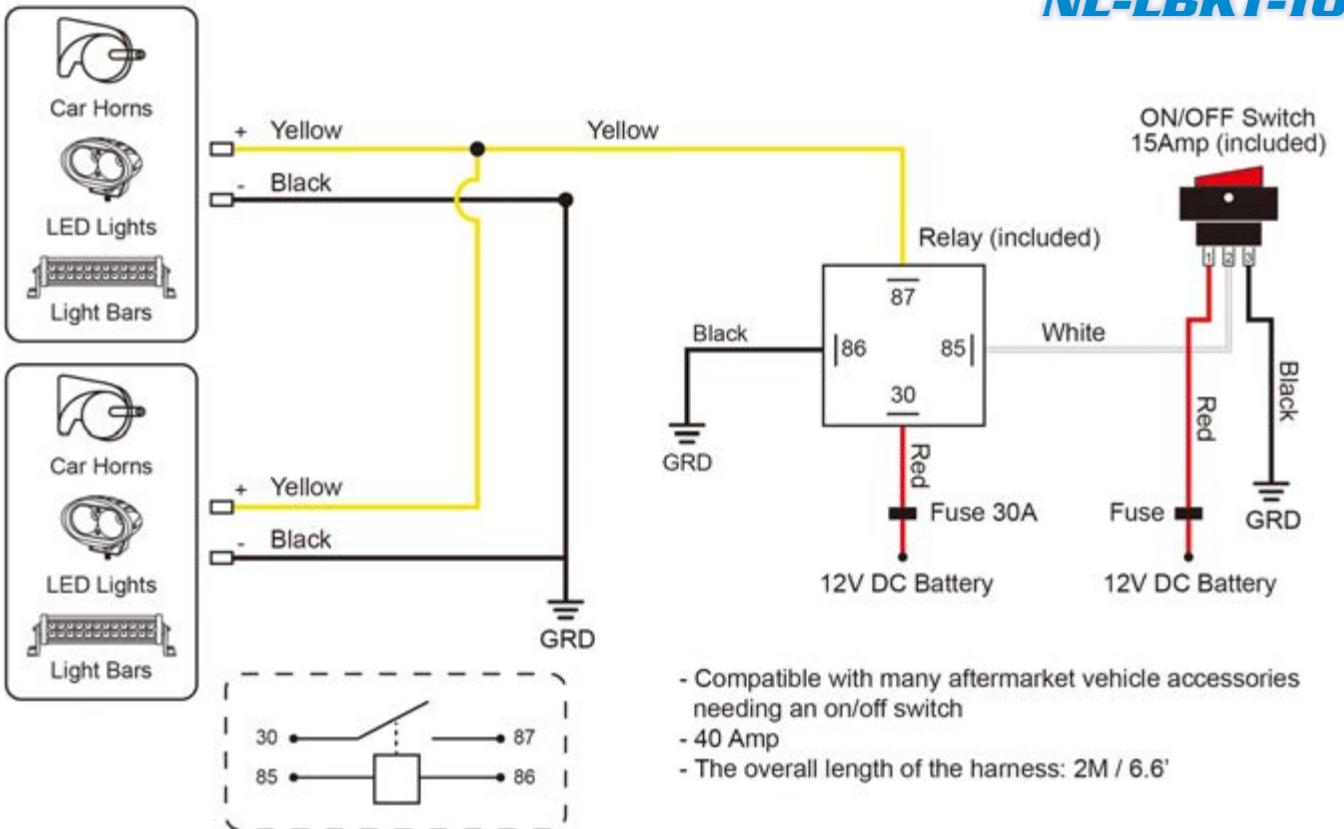

- Compatible with many aftermarket vehicle accessories needing an on/off switch
- 40 Amp
- The overall length of the harness: 2M / 6.6'

**FUNCTION KEY**

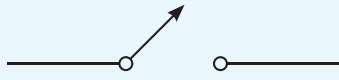

**SPST**  
SINGLE POLE / SINGLE THROW

A Single Pole Single Throw (SPST) switch is a switch that only has a single input and can connect only to one output. This means it only has one input terminal and only one output terminal. A Single Pole Single Throw switch serves in circuits as on-off switches. When the switch is closed, the circuit is on.

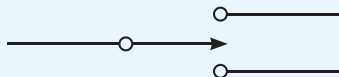

**SPDT**  
SINGLE POLE / DOUBLE THROW

A Single Pole Double Throw (SPDT) switch is a switch that only has a single input and can connect to and switch between the 2 outputs. This means it has one input terminal and two output terminals. A Single Pole Double Throw switch can serve a variety of functions in a circuit.

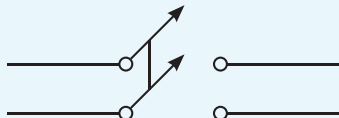

**DPST**  
DOUBLE POLE / SINGLE THROW

A Double Pole Single Throw (DPST) switch is a switch that has 2 inputs and 2 outputs; each input has 1 corresponding output. Each of the terminals of a double pole single switch can either be in the on position (closed) or in the off position (open).

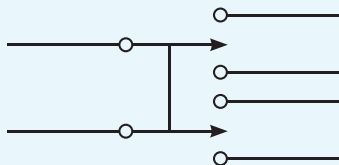

**DPDT**  
DOUBLE POLE / DOUBLE THROW

A Double Pole Double Throw (DPDT) switch is a switch that has 2 inputs and 4 outputs; each input has 2 corresponding outputs that it can connect to. Each of the terminals of a double pole double switch can either be in 1 of 2 positions. This makes the the double pole double throw switch a very versatile switch.

**EC-PHPL10A12V**

**SPST UNIVERSAL PUSH-PULL SWITCH**

- Current Rating: 10A 12VDC; 6A 30VDC
- Contact resistance: < 50MΩ
- Insulation resistance: >500VDC 1000MΩ Minute
- Dielectric Strength: >1500VAC, 1 Minute
- Operating Temperature: -25°C~+85°C
- Mechanical life: >50000 CYCLES
- Electrical life: >10000 CYCLES
- Height: 17mm
- 2 Pins

Ideal for controlling the high and low light on your automobile headlights. Also perfect for control of bus doors and other uses.



**TOGGLE SWITCHES**

EPS-3015BLK (Black)

EPS-3015CF (Carbon)

EPS-3015CHR (Chrome)

EPS-3015BLU (Blue)

EPS-3015RED (Red)



**ILLUMINATED PILOT SAFETY TOGGLE SWITCH**

- Long lifespan: About 10,000 cycles
- Ergonomic design: Toggle switch with dustproof and waterproof black safety cover, and rocker with white LED light
- Rating: 12V-20A
- Body size: 1.1" x 0.6" x 2.7" (L\*W\*H)
- Mount Hole Size: 1/2 Inch

Can be used as a switch for various electrical applications inside & outside the car. Such as ignition boost, fans, lights, winches, NOS systems, class A amp fans, computer LED's, and more.



**IS-EC-MT1220BLU**

**METAL TOGGLE SWITCH WITH BLUE LED AND 6" LEAD WIRE**

- Current Rating: 20A, 12V
- 2 Pins
- Blue LED
- 6" Lead Wire
- Mount Hole Size: 1/2 Inch



**IS-EC-MT1220RED**

**METAL TOGGLE SWITCH WITH RED LED AND 6" LEAD WIRE**

- Current Rating: 20A, 12V
- 2 Pins
- Red LED
- 6" Lead Wire
- Mount Hole Size: 1/2 Inch



**IS-EC-W1210 CVR**

**HEAVY DUTY ON/OFF TOGGLE SWITCH WITH WATERPROOF BOOT CAP COVER**

- Applicable for All 12-24 DC Volts Connections
- Heavy-Duty Toggle Switch Suitable for Marine, Industrial, or Automotive Applications
- Made from Sturdy Material that Ensures Long Lasting Durability, Facilitate Easy Installation
- Power: 10A 250VAC / 20A 125VAC
- Mount Hole Size: 1/2 Inch



**10 / 20 A**

**IS-EC-W1220 CVR**

**HEAVY DUTY ON/OFF TOGGLE SWITCH WITH WATERPROOF BOOT CAP COVER**

- Applicable for All 12-24 DC Volts Connections
- Heavy-Duty Toggle Switch Suitable for Marine, Industrial, or Automotive Applications
- Made from Sturdy Material that Ensures Long Lasting Durability, Facilitate Easy Installation
- Power: 20A 250VAC / 15A 125VAC
- Mount Hole Size: 1/2 Inch



**20 / 15 A**

**IS-EC-WI215 CVR**

**SPST ON/OFF TOGGLE SWITCH WITH WATERPROOF BOOT CAP COVER**

- Applicable for all 12-24 DC Volts Connections
- Heavy-Duty Toggle Switch Suitable for Marine, Industrial, or Automotive Applications
- Made from Sturdy Material that Ensures Long Lasting Durability, Facilitate Easy Installation
- Power: 15A 125VAC
- 2 Pins
- Mount Hole Dimensions: 1/2 Inch



**15 AMP**



**IS-EC-WI215MC**

**SPST WATERPROOF MOMENTARY ON TOGGLE SWITCH**

- Applicable for all 12 DC volt connections
- Heavy-Duty toggle switch suitable for marine, industrial, or automotive applications
- Made from sturdy material that ensures long lasting durability, facilitate easy installation
- Power: 15A 125VAC
- 2 Pins
- Mount Hole Dimensions: 1/2 Inch

**15 AMP**



For horns or temporary Lighting.  
Heavy-duty spade type terminal.  
1/2" mounting hole required.



**IS-EC-WI215DC**

**SPDT WATERPROOF DUAL PURPOSE (ON-OFF-ON) TOGGLE SWITCH**

- Material: plastic and metal. Solid connection switch with waterproof rubber cap, more convenient to operate.
- Connector type: SPST, 3 terminal pin on/off.
- Power: 15A 250VAC/20A 125VAC, 2 pole (2 wire contacts to hook to) switch, red positive, the standard "hot" wire, black is negative
- Mechanical life: more than 50,000 cycles.
- Electrical life: more than 10,000 cycles. Each of the terminals has a machine screw for quick connections, but also easy to be soldered
- Dimensions: 1.12" x 0.63" x 2.21"
- Mount Hole Size: 1/2 Inch

**15 AMP**



Ideal for industrial equipment,  
automotive or emergency lighting.  
1/2" mounting hole required.



**IS-EC-IT1220BLU**

**ILLUMINATED TOGGLE SWITCH WITH 6" LEAD WIRE**

- Current Rating: 20A, 12V
- 3 Pins
- Blue Color
- 6" Lead Wire
- Mount Hole Size: 1/2 Inch



**IS-EC-IT1220RED**

**ILLUMINATED TOGGLE SWITCH WITH 6" LEAD WIRE**

- Current Rating: 20A, 12V
- 3 Pins
- Blue Color
- 6" Lead Wire
- Mount Hole Size: 1/2 Inch



**TOGGLE SWITCHES**

**EC-1521MM**

**DPDT MOMENTARY ON-OFF-ON TOGGLE SWITCH**

- Current Rating: 20A, 125V, 15A, 250V
- 6 Pins
- 117V AC
- Mounting Hole Size: 12/25 Inch



**20 AMP**

**EC-1522**

**SPST ON-OFF TOGGLE SWITCH**

- Current Rating: 20A, 125V, 10A, 250V
- 2 Pins
- 117V AC
- Mounting Hole Size: 12/25 Inch



**20 AMP**

**EC-1523**

**SPDT ON-OFF-ON TOGGLE SWITCH**

- Current Rating: 15A, 125V, 10A, 250V
- 6 Pins
- 117V AC
- Mounting Hole Size: 12/25 Inch



**15 AMP**

**EC-1535**

**SPDT ON-OFF-ON TOGGLE SWITCH**

- Current Rating: 15A, 125V, 10A, 250V
- 3 Pins
- 117V AC
- Mounting Hole Size: 12/25 Inch



**20 AMP**

**EC-2510**

**SPST ON-OFF MINI TOGGLE SWITCH**

- Current Rating: 6A, 125V, 3A, 250V
- 2 Pins
- Mounting Hole Size: 1/4 Inch



**6 AMP**

**EC-2530**

**SPDT ON-OFF-ON MINI TOGGLE SWITCH**

- Current Rating: 6A, 125V, 3A, 250V
- 3 Pins
- Mounting Hole Size: 1/4 Inch



**6 AMP**

**EC-2550**

**DPDT ON-OFF-ON MINI TOGGLE SWITCH**

- Current Rating: 6A, 125V, 3A, 250V
- 6 Pins
- Mounting Hole Size: 1/4 Inch



**6 AMP**



**EC-1500**

**DPDT CENTER-OFF TOGGLE SWITCH**

- Mounting Hole Size: 12/25 Inch
- 117V AC
- 6 AMP
- 6 Pins



**6 AMP**

**EC-1501**

**DPDT CENTER-OFF TOGGLE SWITCH**

- Mounting Hole Size: 12/25 Inch
- 117V AC
- 3 AMP
- 6 Pins



**3 AMP**

**EC-1502**

**DPDT CENTER-OFF TOGGLE SWITCH**

- Mounting Hole Size: 12/25 Inch
- 117V AC
- 4 AMP
- 4 Pins



**4 AMP**

**EC-1503**

**DPDT CENTER-OFF TOGGLE SWITCH**

- Mounting Hole Size: 12/25 Inch
- 117V AC
- Current Rating: 4A-125V, 2A-250V AC
- 3 AMP
- 2 Pins



**3 AMP**

**EC-1510**

**DPDT CENTER-OFF TOGGLE SWITCH**

- Mounting Hole Size: 12/25 Inch
- 117V AC
- Current Rating: 6A-250V, 10A-125V AC
- 10 AMP
- 6 Pins



**10 AMP**

**EC-1515**

**DPDT ON-OFF-ON TOGGLE SWITCH**

- Mounting Hole Size: 12/25 Inch
- 117V AC
- Current Rating: 10A-250V, 15A-125V AC
- 15 AMP
- 6 Pins



**15 AMP**

**EC-1512**

**SPST ON-OFF TOGGLE SWITCH**

- Mounting Hole Size: 12/25 Inch
- 117V AC
- Current Rating: 10A-250V, 15A-125V AC
- 15 AMP
- 2 Pins



**15 AMP**

**EC-1520**

**DPDT CENTER-OFF TOGGLE SWITCH**

- Mounting Hole Size: 12/25 Inch
- 117V AC
- Current Rating: 20A-126V, 10A-250V AC
- 20 AMP
- 6 Pins



**20 AMP**

**ROCKER SWITCHES**

**IS-EC-WP1213BLACK**

**IS-EC-WP1213BLU**

**IS-EC-WP1213RED**



**SPST LED ILLUMINATED ON/OFF  
ROCKER SWITCH**

- Current Rating: 10A 12V
- 3 Pins
- Waterproof
- Mounting Diameter: 3/4 Inch

**IS-EC-WP1216BLU**

**IS-EC-WP1216GRN**

**IS-EC-WP1216RED**



**SPST LED ILLUMINATED ON/OFF  
ROCKER SWITCH**

- Current Rating: 16A 12V
- 3 Pins
- Waterproof
- Mounting Diameter: 3/4 Inch

**EC-1103**

**SPST ON/OFF ROCKER SWITCH**



- Current Rating: 6A 250V, 10A 125V
- 3 Pins
- For 110V Applications
- Mounting Diameter: 3/4 Inch

**EC-1103ABL**

**SPST ON/OFF ROCKER SWITCH  
WITH BLUE LED ON INDICATOR**



- Current Rating: 6.5A 250V, 13A 125V
- 3 Pins
- For 110V Applications
- Mounting Diameter: 3/4 Inch

**EC-1103ARD**

**SPST ON/OFF ROCKER SWITCH  
WITH RED LED ON INDICATOR**



- Current Rating: 6.5A 250V, 13A 125V
- 3 Pins
- For 110V Applications
- Mounting Diameter: 3/4 Inch

**EC-1210SCR**

**SPST ON/OFF ROCKER SWITCH**



- Current Rating: 10A 125V, 6A 250V
- 2 Pins
- For 110V Applications
- Mounting Diameter: 3/4 Inch

**ROCKER SWITCHES**

**EC-1213 BLU**

**SPST ON/OFF ROCKER SWITCH WITH BLUE LED ON INDICATOR**

- 3 Pins
- Mounting Diameter: 3/4 Inch
- For 12V Applications



**EC-1213 RED**

**SPST ON/OFF ROCKER SWITCH WITH RED LED ON INDICATOR**

- 3 Pins
- Mounting Diameter: 3/4 Inch
- For 12V Applications



**EC-1215**

**SPST LED ILLUMINATED ON/OFF ROCKER SWITCH**

- Current Rating: 10A 12V
- 3 Pins
- Red LED
- Mounting Diameter: 3/4 Inch



**EC-1217 BLU**

**SPST LED ILLUMINATED ON/OFF ROCKER SWITCH**

- Current Rating: 10A 12V
- 3 Pins
- Blue LED
- Mounting Diameter: 3/4 Inch



**EC-1213**

**SPST ON/OFF ROCKER SWITCH**

- Current Rating: 10A 12V
- 2 Pins
- Mounting Diameter: 3/4 Inch



**IS-EC-RS12513**

**SPST ON/OFF MINI ROCKER SWITCH WITH 6" LEAD WIRE**

- Current Rating: 6.5A 250V, 13A 125V
- 2 Pins
- Mounting Diameter: 3/4 Inch



**IS-EC-RS1216RED**

**SPST ON/OFF MINI ROCKER SWITCH WITH RED LED INDICATOR AND 6" LEAD WIRE**

- Current Rating: 16A 12V
- 3 Pins
- Mounting Diameter: 3/4 Inch



**IS-EC-RS1216BLU**

**SPST ON/OFF MINI ROCKER SWITCH WITH BLUE LED INDICATOR AND 6" LEAD WIRE**

- Current Rating: 16A 12V
- 3 Pins
- Mounting Diameter: 3/4 Inch



**IS-EC-IR1216RED**

**SPST LED ILLUMINATED ON/OFF MINI ROCKER SWITCH WITH 6" LEAD WIRE**

- Current Rating: 16A 12V
- 3 Pins
- Mounting Diameter: 3/4 Inch
- Red LED



**IS-EC-IR1216BLU**

**SPST LED ILLUMINATED ON/OFF MINI ROCKER SWITCH WITH 6" LEAD WIRE**

- Current Rating: 16A 12V
- 3 Pins
- Mounting Diameter: 3/4 Inch
- Blue LED



**IS-EC-DVL12-BLU**

**LED ILLUMINATED ON/OFF  
OVAL SPST ROCKER SWITCH**



- Easily Fits in 12mm Diameter Opening
- Designed to Connect and Disconnect an Electrical Circuit at will - Applicable for Car, Motorcycle, Boat, UTV, RV
- Lower LED is Independent and can be Wired to Separate Dash Light Circuit
- Material: ABS
- LED Light Color: Blue
- Current Rating: 20A 12V
- 3 Pins

**IS-EC-DVL12-RED**

**LED ILLUMINATED ON/OFF  
OVAL SPST ROCKER SWITCH**



- Easily Fits in 12mm Diameter Opening
- Designed to Connect and Disconnect an Electrical Circuit at will - Applicable for Car, Motorcycle, Boat, UTV, RV
- Lower LED is Independent and can be Wired to Separate Dash Light Circuit
- Material: ABS
- LED Light Color: Red
- Current Rating: 20A 12V
- 3 Pins

**ECSW-RSOF-BLU**

**LED ILLUMINATED ON/OFF MARINE  
GRADE SPDT ROCKER SWITCH**



- Marine grade
- 3 pins
- On-Off SPDT Rocker switch
- Blue led status indicator
- 12V 20A DC
- 24V 10A DC

**ECSW-RSOF-RED**

**LED ILLUMINATED ON/OFF MARINE  
GRADE SPDT ROCKER SWITCH**



- Marine grade
- 3 pins
- On-Off SPDT Rocker switch
- Red led status indicator
- 12V 20A DC
- 24V 10A DC

**ECSW-RSOF**

**ON/OFF MARINE GRADE SPDT  
ROCKER SWITCH**



- Marine grade
- 2 pins
- On-Off SPDT Rocker switch
- 12V 20A DC
- 24V 10A DC

**ECSW-MOU-SIN**

**MOUNTING PANEL FOR  
ROCKER SWITCH**

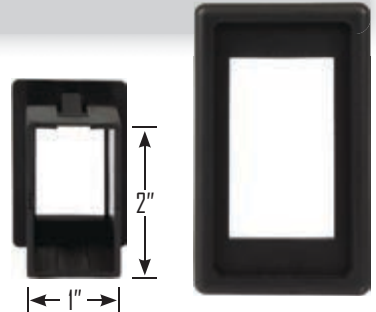

- Marine grade
- Compatible with:  
ECSW-RSOF-RED  
ECSW-RSOF-BLU  
ECSW-RSOF

**ECSW-MOU-MID**

**MOUNTING PANEL MIDDLE PIECE**



- Compatible with:  
ECSW-RSOF-RED  
ECSW-RSOF-BLU  
ECSW-RSOF

Combine pieces to create your own personalized marine panel control center

**ECSW-MOU-END**

**MOUNTING PANEL END PIECE**



- Compatible with:  
ECSW-RSOF-RED  
ECSW-RSOF-BLU  
ECSW-RSOF

Combine pieces to create your own personalized marine panel control center

**EC-1220 BLU**

**SPST LED ILLUMINATED ON/OFF  
MINI ROCKER SWITCH**

- Mount Hole Dimensions: 1/2" x 3/4"
- Current Rating: 10A 12V
- LED Light Color: Blue
- 3 Pins
- Overall Dimensions: 1-1/16 x 1/2



**EC-1220 RED**

**SPST LED ILLUMINATED ON/OFF  
MINI ROCKER SWITCH**

- Mount Hole Dimensions: 1/2" x 3/4"
- Current Rating: 10A 12V
- LED Light Color: Red
- 3 Pins
- Overall Dimensions: 1-1/16 x 1/2



**EC-1220 WHT**

**SPST LED ILLUMINATED ON/OFF  
MINI ROCKER SWITCH**

- Mount Hole Dimensions: 1/2" x 3/4"
- Current Rating: 10A 12V
- LED Light Color: White
- 3 Pins
- Overall Dimensions: 1-1/16 x 1/2



**EC-2602**

**SPST ON/OFF ROCKER SWITCH**

- Current Rating: 20A 125V AC
- 2 Pins
- Mount Hole Dimensions: 1 x 13/32



**EC-2604**

**DPDT ON/OFF ROCKER SWITCH**

- Current Rating: 10A 125V AC
- 4 Pins
- Mount Hole Dimensions: 1 x 13/16



**EC-2606**

**DPDT ON/OFF ROCKER SWITCH**

- Current Rating: 10A 125V AC
- 6 Pins
- Mount Hole Dimensions: 1 x 13/16



**EC-2636**

**DPDT ON/OFF ROCKER SWITCH**

- Current Rating: 3A 125V AC
- 6 Pins
- Mount Hole Dimensions: 1" x 13/16"



**EC-315**

**SPST ILLUMINATED ON/OFF  
ROCKER SWITCH**

- Current Rating: 15A 125V AC
- 3 Pins
- Mount Hole Dimensions: 1 x 1/2



**EC-620**

**DPDT ILLUMINATED ON/OFF  
ROCKER SWITCH**

- Current Rating: 20A 125V
- 6 Pins
- Mount Hole Dimensions: 1 x 13/16

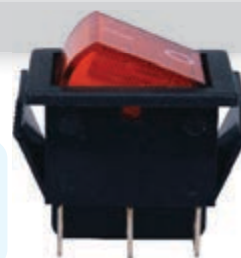

**EC-623**

**DPDT ILLUMINATED ON/OFF  
ROCKER SWITCH**

- Current Rating: 20A 125V
- 6 Pins
- Mount Hole Dimensions: 1 x 7/8



**EC-1115**

**SPST ON/OFF ROCKER SWITCH**

- Current Rating: 3A 250V, 6A 125V
- 2 Pins
- Mount Hole Dimensions: 1/2 x 11/32



**EC-1115PP**

**SPST ON/OFF ROCKER SWITCH**

- Current Rating: 3A 250V, 6A 125V
- 3 Pins
- Mount Hole Dimensions: 3/4 x 1/2



**IS-EP-WB123BLU**

**LED ILLUMINATED PUSH BUTTON SWITCH**

- Mounting Diameter: 5/8 Inch
- Switch Rating: 3A/250AC
- Operation Type: Push it - ON, Push it again - OFF
- Power Symbol LED can be on all the time or only when the switch is on which depends on how you wire it
- Great for Electric Switch, Relay, Power Button Switch, Critical Lights, Chassis Lamp, Fog Lamps, Door Switch, Led Switch or any Circuit Controls on over 500,000 Cycles
- High-Quality Metal Material & IP65 Waterproof Protection, can be used in Wet or Dusty Environments



**IS-EP-WB123RED**

**LED ILLUMINATED PUSH BUTTON SWITCH**

- Mounting Diameter: 5/8 Inch
- Switch Rating: 3A/250AC
- Operation Type: Push it - ON, Push it again - OFF
- Power Symbol LED can be on all the time or only when the switch is on which depends on how you wire it
- Great for Electric Switch, Relay, Power Button Switch, Critical Lights, Chassis Lamp, Fog Lamps, Door Switch, Led Switch or any Circuit Controls on over 500,000 Cycles
- High-Quality Metal Material & IP65 Waterproof Protection, can be used in Wet or Dusty Environments



**IS-EP-WS123BLU**

**LED ILLUMINATED PUSH BUTTON SWITCH**

- Mounting Diameter: 5/8 Inch
- Switch Rating: 3A/250AC
- Operation Type: Push it - ON, Push it again - OFF
- Ring LED can be on all the time or only when switch is on which depends on how you wire it
- Great for Electric Switch, Relay, Power Button Switch, Critical Lights, Chassis Lamp, Fog Lamps, Door Switch, Led Switch or any Circuit Controls on Over 500,000 Cycles
- High-Quality Metal Material & IP65 Waterproof Protection, can be Used in Wet or Dusty Environments

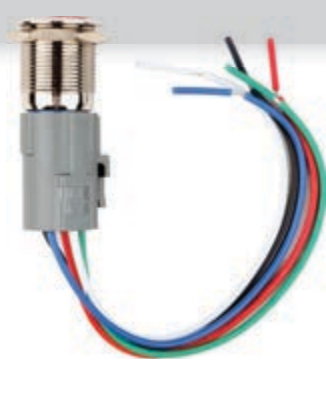

**IS-EP-WS123RED**

**LED ILLUMINATED PUSH BUTTON SWITCH**

- Mounting Diameter: 5/8 Inch
- Switch Rating: 3A/250AC
- Operation Type: Push it - ON, Push it again - OFF
- Ring LED can be on all the time or only when switch is on which depends on how you wire it
- Great for Electric Switch, Relay, Power Button Switch, Critical Lights, Chassis Lamp, Fog Lamps, Door Switch, Led Switch or any Circuit Controls on Over 500,000 Cycles
- High-Quality Metal Material & IP65 Waterproof Protection, can be Used in Wet or Dusty Environments



**NB-803M-RED**  
**NB-803M-BLK**  
**NB-803M-BLU**  
**NB-803M-WHT**

**MOMENTARY PUSH SWITCH**

- 20A 125V
- 15A 250V
- 3 Pins
- Mounting Diameter: 1/2 Inch

This switch can be used in countless applications, from basic ON-OFF to multifunction applications. Most of our electrical switches are suitable for marine, industrial, or automotive applications.



**ECR-12615**

**MOMENTARY "PUSH TO ACTIVATE" SWITCH**

- 3A 30V DC
- 6A 12V DC
- Contact R: 50mΩ max
- Insulation R: 500V DC 100MΩ min
- Mounting Diameter: 2-1/4 Inch

For boat horns, starter switches, doorbells and other applications in which temporary activation of an electrical circuit is desired. Operation type: momentary (Activates when pressed, deactivates when released)



**NB-804PA**

**MOMENTARY "PUSH TO ACTIVATE" SWITCH**

- 4A 125V AC
- 2A 250V AC
- Mounting Diameter: 3/4 Inch



For boat horns, starter switches, and other applications in which temporary disactivation of an electrical current is desired. Operation Type: Momentary

**NB-804PD**

**MOMENTARY "PUSH TO DISACTIVATE" SWITCH**

- 4A 125V AC
- 2A 250V AC
- Mounting Diameter: 3/4 Inch



For boat horns, starter switches, and other applications in which temporary disactivation of an electrical current is desired. Operation Type: Momentary

**NB-602PA**

**MOMENTARY "PUSH TO ACTIVATE" SWITCH**

- Current Rating: 3A 125V AC
- 2 Pins
- Mounting Diameter: 1/4 Inch



**NB-602PD**

**MOMENTARY "PUSH TO DEACTIVATE" SWITCH**

- Current Rating: 3A 125V AC
- 2 Pins
- Mounting Diameter: 1/4 Inch



**PUSH / MISCELLANEOUS**  
**SWITCHES**

**EC-4112S**

**SURFACE MOUNT MINI PUSH SWITCH**

- 0.1A, 12V
- Dimension: 12x12mm
- Height of the button: 0.25mm
- Total height: 4.25mm



**EC-4112D**

**THRU MOUNT MINI PUSH SWITCH**

- 0.1A, 12V
- Dimension: 12x12mm
- Height of the button: 0.25mm
- Total height: 4.25mm



**NB-802**

**MOMENTARY ON-OFF SPST MINI PUSH SWITCH**

- Square
- Current Rating: 3A 125V AC
- 2 Pins



**NB-805**

**MOMENTARY PUSH SWITCH**

- Current Rating: 3A 125V AC
- 2 Pins



**IS-EC-PB1216RED**

**MOMENTARY PUSH SWITCH WITH 40" LEAD WIRE**

- Current Rating: 16A, 12V
- Mount Hole: 1/4"
- 2 Pins



**IS-EC138-ALM**

**VALET SWITCH WITH 36" LEAD WIRE**

- Life: 100,000 Times
- 2 Cables/BLACK, GREY



**EC-4063-4.3**

**MICRO BUTTON SWITCH**

- 6 x 6 x 4.3mm
- Temperature: -30 ~ +70° C
- Withstand Voltage: AC250V
- Power: DC12V 50mA
- White
- 180 GF
- DIP



**EC-4066-4.3**

**MICRO BUTTON SWITCH**

- 6 x 6 x 4.3mm
- Temperature: -30 ~ +70° C
- Withstand Voltage: AC250V
- Power: DC12V 50mA
- Black
- 180 GF
- DIP





**EC-4066-5.0**

**MICRO BUTTON SWITCH**

- 6 x 6 x 5mm
- Temperature: -30 ~ +70° C
- Withstand Voltage: AC250V
- Power: DC12V 50mA
- Black
- 180 GF
- DIP



**EQ-CON-12V**

**REPLACEMENT MOLEX  
TYPE POWER CONNECTOR**

- For EQ, Crossover and other audio processors



**EC-1210**

**SPST MINI ON-OFF  
ROCKER SWITCH**

- Mount Hole: 1/2" x 3/4"
- Current Rating: 10A 12V
- 2 Pins
- 3/4 x 1/2



**AR-110**

**SPDT ON-ON MINI SLIDE SWITCH**

- Current Rating: 3A 125V AC
- 3 Pins

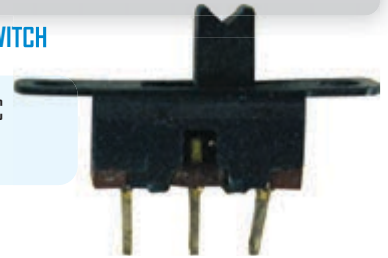

**EC-126**

**SPST ON-OFF TOGGLE  
SWITCH WITH 24" LEAD WIRE**

- Pre-Wired 2" Long
- Current Rating: 6A 125V
- 2 Pins



**VS-1122**

**SPDT VOLTAGE SWITCH**

- 3 Pins
- 110/220 V



**EC-284**

**SPDT ON-ON MICRO SWITCH**

- Current Rating: 10A 125V AC
- 2 Pins



**EC-285**

**SPDT ON-ON MICRO SWITCH**

- Current Rating: 3A 125V AC
- 3 Pins



**VOLTAGE DISPLAYS**

**IS-LD-AVMS-12**

**DUAL AMP/VOLTAGE DISPLAY**

- Input 12-24V, 5A
- Blue LED Display
- Material: High Quality Nylon Plastic Socket Body
- Fitment: Universal Fits for 12-24V Vehicle, Motorcycle, ATV, Boat, Car or Marine



**IS-LD-DVS-12**

**DIGITAL VOLTAGE DISPLAY**

- Blue LED Display
- Material: High Quality Nylon Plastic Socket Body
- Fitment: Universal Fits for 12-24V Vehicle, Motorcycle, ATV, Boat, Car or Marine



**IS-LD-USBVS-12**

**DIGITAL VOLTAGE DISPLAY WITH USB FAST CHARGER**

- Blue LED Display
- Material: High Quality Nylon Plastic Socket Body
- Fitment: Universal Fits for 12-24V Vehicle, Motorcycle, ATV, Boat, Car or Marine



**IS-EC-12MT-BLU**

**SPST ROCKER SWITCH WITH BLUE LED ON INDICATOR AND SWITCH HOUSING**

- Easy Setup. All you Need is a 3/4" Hole and the Switch will Sit in Nicely
- Frames are Nylon, Terminals are Silver Plated Brass
- Illumination: DOT Styled, 12V LED Light
- Type: 3 Pins with LED SPST: ON-OFF
- Rating: 12V / DC. 20A
- LED Color: Blue
- Size: 37x29mm



**IS-EC-PRSMT-1**

**SINGLE CAR CHARGER OUTLET DASHBOARD MOUNT ADAPTER**

- Easily installed in any car, motorcycle, ATV, boat, riding mower, etc.
- Color: Black
- Material: ABS
- Fire retardant
- Size: 53x49x78mm
- Fits all of our voltage display models



**IS-EC-PRSMT-2**

**DOUBLE CAR CHARGER OUTLET DASHBOARD MOUNT ADAPTER**

- Easily installed in any car, motorcycle, ATV, boat, riding mower, etc.
- Color: Black
- Material: ABS
- Fire retardant
- Size: 96x49x78x71mm
- Fits all of our voltage display models

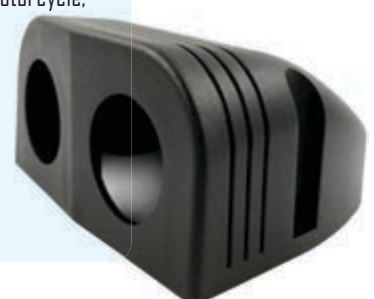

**IS-ALD-2UV-BLK**

**DIGITAL VOLTAGE DISPLAY WITH  
DUAL FAST USB CHARGER**

- Product (hole) Size: 37x49x28.8mm
- 36g
- 7075 Aluminum
- Input Voltage: 12-24V
- Output Voltage: 5V
- Blue LED display
- Body color: Black



**IS-ALD-2UV-BLU**

**DIGITAL VOLTAGE DISPLAY WITH  
DUAL FAST USB CHARGER**

- Product (hole) Size: 37x49x28.8mm
- 36g
- 7075 Aluminum
- Input Voltage: 12-24V
- Output Voltage: 5V
- Blue LED display
- Body color: Blue



**IS-ALD-2UB-BLK**

**DIGITAL VOLTAGE AND AMP DISPLAY WITH  
DUAL FAST USB CHARGER**

- Product(hole) Size: 37x49x28.8mm
- 32g
- 7075 Aluminum
- Input Voltage: 12-24V
- Output Voltage: 5V
- Output Current: 2.1A+2.1A
- Blue LED display
- Body color: Black

Dual USB charger socket has two fast charging ports. Very useful for car, boat, SUV, ATV, RV car, campers and motorcycles, etc. It is compatible with most vehicles with a voltage of DC 12-24V connections.



**IS-ALD-UVA-BLK**

**DIGITAL VOLTAGE AND AMP DISPLAY WITH  
FAST USB CHARGER**

- Product(hole) Size: 37x49x28.8mm
- 27g
- 7075 Aluminum
- Input Voltage: 12-24V
- Output Voltage: 5V
- Blue LED display
- Body color: Black

USB charger socket has a fast charging port, Which is 4x faster than conventional chargers and an LED voltage and current display that can show the voltage and AMP status of car battery in real time. Very useful for car, boat, SUV, ATV, RV car, campers and motorcycles, etc. It is compatible with most vehicles with a voltage of DC 12-24V connections.



**IS-PTRC-0-8**

**CRIMP TYPE**

**CRIMP TYPE COPPER RING TERMINAL LUG**

- 0 Gauge
  - Stud Size #1/4"
  - Insulated - Pure Copper Allows Maximum Conductivity
  - Black heat shrink included
  - Heavy duty construction for enhanced high temperature durability.
- Perfect for cable ends that connect to the battery terminals or corresponding battery switch installation
  - Widely used for car, vehicle, RV, boat, also solar panels, home applications, electrical equipment etc.



**IS-PTRC-0-10**

**CRIMP TYPE**

**CRIMP TYPE COPPER RING TERMINAL LUG**

- 0 Gauge
  - Stud Size #5/16"
  - Insulated - Pure Copper Allows Maximum Conductivity
  - Black heat shrink included
  - Heavy duty construction for enhanced high temperature durability.
- Perfect for cable ends that connect to the battery terminals or corresponding battery switch installation
  - Widely used for car, vehicle, RV, boat, also solar panels, home applications, electrical equipment etc.



**IS-PTRC-4-8**

**CRIMP TYPE**

**CRIMP TYPE COPPER RING TERMINAL LUG**

- 4 Gauge
  - Stud Size #1/4"
  - Insulated - Pure Copper Allows Maximum Conductivity
  - Black heat shrink included
  - Heavy duty construction for enhanced high temperature durability.
- Perfect for cable ends that connect to the battery terminals or corresponding battery switch installation
  - Widely used for car, vehicle, RV, boat, also solar panels, home applications, electrical equipment etc.



**IS-PTRC-4-10**

**CRIMP TYPE**

**CRIMP TYPE COPPER RING TERMINAL LUG**

- 4 Gauge
  - Stud Size #5/16"
  - Insulated - Pure Copper Allows Maximum Conductivity
  - Black heat shrink included
  - Heavy duty construction for enhanced high temperature durability.
- Perfect for cable ends that connect to the battery terminals or corresponding battery switch installation
  - Widely used for car, vehicle, RV, boat, also solar panels, home applications, electrical equipment etc.



**IS-PTRC-8-8**

**CRIMP TYPE**

**CRIMP TYPE COPPER RING TERMINAL LUG**

- 8 Gauge
  - Stud Size #1/4"
  - Insulated - Pure Copper Allows Maximum Conductivity
  - Black heat shrink included
  - Heavy duty construction for enhanced high temperature durability.
- Perfect for cable ends that connect to the battery terminals or corresponding battery switch installation
  - Widely used for car, vehicle, RV, boat, also solar panels, home applications, electrical equipment etc.



**IS-PTRCST-008**

**SOLDER TYPE COPPER RING TERMINAL LUG**

- 0 Gauge
- Stud Size #1/4"
- Insulated - Pure Copper Allows Maximum Conductivity
- Black heat shrink included
- Heavy duty construction for enhanced high temperature durability.

- Perfect for cable ends that connect to the battery terminals or corresponding battery switch installation
- Widely used for car, vehicle, RV, boat, also solar panels, home applications, electrical equipment etc.

**SOLDER TYPE**



**IS-PTRCST-010**

**SOLDER TYPE COPPER RING TERMINAL LUG**

- 0 Gauge
- Stud Size #5/16"
- Insulated - Pure Copper Allows Maximum Conductivity
- Black heat shrink included
- Heavy duty construction for enhanced high temperature durability.

- Perfect for cable ends that connect to the battery terminals or corresponding battery switch installation
- Widely used for car, vehicle, RV, boat, also solar panels, home applications, electrical equipment etc.

**SOLDER TYPE**



**IS-PTRCST-408**

**SOLDER TYPE COPPER RING TERMINAL LUG**

- 4 Gauge
- Stud Size #1/4"
- Insulated - Pure Copper Allows Maximum Conductivity
- Black heat shrink included
- Heavy duty construction for enhanced high temperature durability.

- Perfect for cable ends that connect to the battery terminals or corresponding battery switch installation
- Widely used for car, vehicle, RV, boat, also solar panels, home applications, electrical equipment etc.

**SOLDER TYPE**



**IS-PTRCST-410**

**SOLDER TYPE COPPER RING TERMINAL LUG**

- 4 Gauge
- Stud Size #5/16"
- Insulated - Pure Copper Allows Maximum Conductivity
- Black heat shrink included
- Heavy duty construction for enhanced high temperature durability.

- Perfect for cable ends that connect to the battery terminals or corresponding battery switch installation
- Widely used for car, vehicle, RV, boat, also solar panels, home applications, electrical equipment etc.

**SOLDER TYPE**



**IS-PTRCST-808**

**SOLDER TYPE COPPER RING TERMINAL LUG**

- 8 Gauge
- Stud Size #1/4"
- Insulated - Pure Copper Allows Maximum Conductivity
- Black heat shrink included
- Heavy duty construction for enhanced high temperature durability.

- Perfect for cable ends that connect to the battery terminals or corresponding battery switch installation
- Widely used for car, vehicle, RV, boat, also solar panels, home applications, electrical equipment etc.

**SOLDER TYPE**



**IS-RT-HDD-3/8**

**SOLDER TYPE**

**SOLDER TYPE RING TERMINAL LUG**

- 0 Gauge
- Stud Size #3/8"
- Nickel plated copper
- Heavy duty construction for enhanced high temperature durability.
- Perfect for cable ends that connect to the battery terminals or corresponding battery switch installation
- Pack of 50

**0 GAUGE**  
**3/8" STUD**



**IS-RT-HD4-5/16**

**SOLDER TYPE**

**SOLDER TYPE RING TERMINAL LUG**

- 4 Gauge
- Stud Size #5/16"
- Nickel plated copper
- Heavy duty construction for enhanced high temperature durability.
- Perfect for cable ends that connect to the battery terminals or corresponding battery switch installation
- Pack of 50

**4 GAUGE**  
**5/16" STUD**



**PBTR-0**

**0 AWG GOLD PLATED RING TERMINALS**

- 24 Kt. Gold Plated Terminals
- 1 Positive (Red) & 1 Negative (Black)
- Crimp Style
- PVC Insulator
- Blister Pack
- 0 AWG
- 3/8" Stud

**0 AWG**



**PBTR-4**

**4 AWG GOLD PLATED RING TERMINALS**

- 24 Kt. Gold Plated Terminals
- 2 Positive (Red) & 2 Negative (Black)
- Crimp Style
- PVC Insulator
- Blister Pack
- 4 AWG
- 3/8" Stud

**4 AWG**

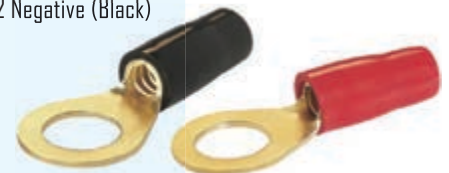

**PBTR-8**

**8 AWG GOLD PLATED RING TERMINALS**

- 24 Kt. Gold Plated Terminals
- 4 Positive (Red) & 4 Negative (Black)
- Crimp Style
- PVC Insulator
- Blister Pack
- 8 AWG
- 3/8" Stud

**8 AWG**



**PTR-0T-RED**

**0 AWG GOLD PLATED RING TERMINALS**

- 0 AWG
- 1/2" Stud
- 24 Kt. Gold Plated Terminals
- Crimp Style
- Red PVC Insulator
- 50 Pieces per bag

**0 AWG**



**PTR-0T-BLK**

**0 AWG GOLD PLATED RING TERMINALS**

- 0 AWG
- 1/2" Stud
- 24 Kt. Gold Plated Terminals
- Crimp Style
- Black PVC Insulator
- 50 Pieces per bag

**0 AWG**



**IS-QD-2218-250**

**FEMALE QUICK DISCONNECT TERMINAL**

- Insulated: 250
- Female quick disconnect
- Pack of 100
- Red

**22-18 GAUGE**



**PTR-0 RED**

0 AWG RING TERMINAL - BULK PACK

- 0 AWG
- 3/8" Stud
- Crimp Style
- PVC Insulator
- 50 Piece Bag

0 AWG



**PTR-0 BLK**

0 AWG RING TERMINAL - BULK PACK

- 0 AWG
- 3/8" Stud
- Crimp Style
- PVC Insulator
- 50 Piece Bag

0 AWG



**PTR-4 RED**

4 AWG RING TERMINAL - BULK PACK

- 4 AWG
- 3/8" Stud
- Crimp Style
- PVC Insulator
- 50 Piece Bag

4 AWG



**PTR-4 BLK**

4 AWG RING TERMINAL - BULK PACK

- 4 AWG
- 3/8" Stud
- Crimp Style
- PVC Insulator
- 50 Piece Bag

4 AWG



**PTR-6 RED**

6 AWG RING TERMINAL - BULK PACK

- 6 AWG
- 3/8" Stud
- Crimp Style
- PVC Insulator
- 50 Piece Bag

6 AWG



**PTR-6 BLK**

6 AWG RING TERMINAL - BULK PACK

- 6 AWG
- 3/8" Stud
- Crimp Style
- PVC Insulator
- 50 Piece Bag

6 AWG



**PTR-8 RED**

8 AWG RING TERMINAL - BULK PACK

- 8 AWG
- 3/8" Stud
- Crimp Style
- PVC Insulator
- 50 Piece Bag

8 AWG



**PTR-8 BLK**

8 AWG RING TERMINAL - BULK PACK

- 8 AWG
- 3/8" Stud
- Crimp Style
- PVC Insulator
- 50 Piece Bag

8 AWG



**PTR-10 RED**

10 AWG RING TERMINAL - BULK PACK

- 10 AWG
- 3/8" Stud
- Crimp Style
- PVC Insulator
- 50 Piece Bag

10 AWG



**PTR-10 BLK**

10 AWG RING TERMINAL - BULK PACK

- 10 AWG
- 3/8" Stud
- Crimp Style
- PVC Insulator
- 50 Piece Bag

10 AWG



**RING TERMINALS**

**IS-RT-1210-10**

VINYL INSULATED RING TERMINAL

- 12 - 10 Gauge
- 1/8" Stud
- Vinyl Insulator
- Pack of 100

**12-10 GAUGE**



**IS-RT-1210-5/16**

VINYL INSULATED RING TERMINAL

- 12 - 10 Gauge
- 5/16" Stud
- Vinyl Insulator
- Pack of 100

**12-10 GAUGE**



**IS-RT-1210-3/8**

VINYL INSULATED RING TERMINAL

- 12 - 10 Gauge
- 3/8" Stud
- Vinyl Insulator
- Pack of 100

**12-10 GAUGE**



**IS-RT-1210-1/4**

VINYL INSULATED RING TERMINAL

- 12 - 10 Gauge
- 1/4" Stud
- Vinyl Insulator
- Pack of 100

**12-10 GAUGE**



**IS-RT-1614-10**

VINYL INSULATED RING TERMINAL

- 16 - 14 Gauge
- 1/8" Stud
- Vinyl Insulator
- Pack of 100

**16-14 GAUGE**



**IS-RT-1614-5/16**

VINYL INSULATED RING TERMINAL

- 16 - 14 Gauge
- 5/16" Stud
- Vinyl Insulator
- Pack of 100

**16-14 GAUGE**



**IS-RT-1614-3/8**

VINYL INSULATED RING TERMINAL

- 16 - 14 Gauge
- 3/8" Stud
- Vinyl Insulator
- Pack of 100

**16-14 GAUGE**



**IS-RT-1614-1/4**

VINYL INSULATED RING TERMINAL

- 16 - 14 Gauge
- 1/4" Stud
- Vinyl Insulator
- Pack of 100

**16-14 GAUGE**



**IS-RT-2218-10**

VINYL INSULATED RING TERMINAL

- 22 - 18 Gauge
- 1/8" Stud
- Vinyl Insulator
- Pack of 100

**22-18 GAUGE**



**IS-RT-2218-1/4**

VINYL INSULATED RING TERMINAL

- 22 - 18 Gauge
- 1/4" Stud
- Vinyl Insulator
- Pack of 100

**22-18 GAUGE**





**MRT-1210-8HS**

MARINE HEAT SHRINK RING TERMINAL

- 12-10 Gauge
- Yellow
- Translucent Vinyl Insulator
- Package of 100

**12-10 GAUGE**



**MRT-1614-6HS**

MARINE HEAT SHRINK RING TERMINAL

- 16-14 Gauge
- Blue
- Translucent Vinyl Insulator
- Package of 100

**16-14 GAUGE**



**MRT-2218-4HS**

MARINE HEAT SHRINK RING TERMINAL

- 22-18 Gauge
- Red
- Translucent Vinyl Insulator
- Package of 100

**22-18 GAUGE**



**MBT-1210-HS**

MARINE HEAT SHRINK BUTT CONNECTOR

- 12-10 Gauge
- Yellow
- Translucent Vinyl Insulator
- Package of 100

**12-10 GAUGE**



**MBT-1614-HS**

MARINE HEAT SHRINK BUTT CONNECTOR

- 16-14 Gauge
- Blue
- Translucent Vinyl Insulator
- Package of 100

**16-14 GAUGE**



**MBT-2218-HS**

MARINE HEAT SHRINK BUTT CONNECTOR

- 22-18 Gauge
- Red
- Translucent Vinyl Insulator
- Package of 100

**22-18 GAUGE**



**MQD-1210-250HS**

MARINE HEAT SHRINK BUTT DISCONNECT CONNECTOR

- 12-10 Gauge
- Yellow
- Translucent Vinyl Insulator
- Package of 100

**12-10 GAUGE**



**MQD-1614-250HS**

MARINE HEAT SHRINK BUTT DISCONNECT CONNECTOR

- 16-14 Gauge
- Blue
- Translucent Vinyl Insulator
- Package of 100

**16-14 GAUGE**



**MQD-2218-250HS**

MARINE HEAT SHRINK BUTT DISCONNECT CONNECTOR

- 22-18 Gauge
- Red
- Translucent Vinyl Insulator
- Package of 100

**22-18 GAUGE**



**MBLF-1614HS**

MARINE BULLET CONNECTOR W/ VINYL INSULATION

- 16-14 AWG
- Blue
- Translucent Vinyl Insulator
- Package of 100

**16-14 AWG**



**BUTT CONNECTORS /  
SPADE TERMINALS**

**IS-BT-1210**

VINYL BUTT CONNECTOR

- 12-10 Gauge
- Yellow
- Full Insulation
- Package of 100

**12-10 GAUGE**



**IS-BT-1614**

VINYL BUTT CONNECTOR

- 16-14 Gauge
- Blue
- Full Insulation
- Package of 100

**16-14 GAUGE**



**IS-BT-2218**

VINYL BUTT CONNECTOR

- 22-18 Gauge
- Red
- Translucent Vinyl Insulator
- Package of 100

**22-18 GAUGE**



**IS-BT-8**

BUTT CONNECTOR

- 8 Gauge
- Red
- Full Insulation
- Package of 100

**8 GAUGE**



**IS-BT-1614NL**

NYLON BUTT CONNECTOR

- 16-14 Gauge
- Blue
- Full Insulation
- Package of 100

**16-14 GAUGE**



**IS-BT-2218NL**

NYLON BUTT CONNECTOR

- 22-18 Gauge
- Red
- Full Insulation
- Package of 100

**22-18 GAUGE**



**IS-SP-1614-10**

VINYL SPADE TERMINAL

- 16-14 Gauge
- #10 Stud Size
- Red
- Full Insulation
- Package of 100

**16-14 GAUGE**



**IS-SP-2218-10**

VINYL SPADE TERMINAL

- 22-18 Gauge
- #10 Stud Size
- Red
- Full Insulation
- Package of 100

**22-18 GAUGE**



**IS-SP-2218-6**

VINYL SPADE TERMINAL

- 22-18 Gauge
- #6 Stud Size
- Red
- Full Insulation
- Package of 100

**22-18 GAUGE**



**IS-SP-1210-10**

VINYL SPADE TERMINAL

- 12-10 Gauge
- #12 Stud Size
- Yellow
- Full Insulation
- Package of 100

**12-10 GAUGE**



**SPADE TERMINALS**

**PTS-14 BLK**

SPADE TERMINAL

**14 GAUGE**

- 14 Gauge
- #8 Stud Size
- Black
- Full Insulation
- Package of 50



**PTS-14 RED**

SPADE TERMINAL

**14 GAUGE**

- 14 Gauge
- #8 Stud Size
- Red
- Full Insulation
- Package of 50



**PTS-10 BLK**

SPADE TERMINAL

**10 GAUGE**

- 10 Gauge
- #8 Stud Size
- Black
- Full Insulation
- Package of 50



**PTS-10 RED**

SPADE TERMINAL

**10 GAUGE**

- 10 Gauge
- #8 Stud Size
- Red
- Full Insulation
- Package of 50



**PTS-8 BLK**

SPADE TERMINAL

**8 GAUGE**

- 8 Gauge
- #8 Stud Size
- Black
- Full Insulation
- Package of 50



**PTS-8 RED**

SPADE TERMINAL

**8 GAUGE**

- 8 Gauge
- #8 Stud Size
- Red
- Full Insulation
- Package of 50



**PTS-4 BLK**

SPADE TERMINAL

**4 GAUGE**

- 4 Gauge
- #10 Stud Size
- Black
- Full Insulation
- Package of 50



**PTS-4 RED**

SPADE TERMINAL

**4 GAUGE**

- 4 Gauge
- #10 Stud Size
- Red
- Full Insulation
- Package of 50



**PTS-6 RED**

SPADE TERMINAL

**6 GAUGE**

- 6 Gauge
- #10 Stud Size
- Red
- Full Insulation
- Package of 50



**PBTS-8**

SPADE TERMINAL

**8 GAUGE**

- 8 Gauge
- #8 Stud Size
- Black & Red
- Full Insulation
- Blister pack of 8



## FEMALE QUICK DISCONNECT TERMINALS

### PBTS-4

#### SPADE TERMINAL

- 4 Gauge
- #10 Stud Size
- Black & Red
- Full Insulation
- Blister pack of 4



### PTD-18 BLK

#### FEMALE QUICK DISCONNECT TERMINAL

- 18 Gauge
- Black
- Full Insulation
- Package of 50



### PTD-18 RED

#### FEMALE QUICK DISCONNECT TERMINAL

- 18 Gauge
- Red
- Full Insulation
- Package of 50



### PTD-16 BLK

#### FEMALE QUICK DISCONNECT TERMINAL

- 16 Gauge
- Black
- Full Insulation
- Package of 50



### PTD-16 RED

#### FEMALE QUICK DISCONNECT TERMINAL

- 16 Gauge
- Red
- Full Insulation
- Package of 50



### PTD-10 BLK

#### FEMALE QUICK DISCONNECT TERMINAL

- 10 Gauge
- Black
- Full Insulation
- Package of 50



### PTD-10 RED

#### FEMALE QUICK DISCONNECT TERMINAL

- 10 Gauge
- Red
- Full Insulation
- Package of 50



### IS-QD-2216-110

#### FEMALE QUICK DISCONNECT TERMINAL

- Pack of 100
- 22-16 Gauge
- Insulated: 110
- Red



### IS-QD-2218-187

#### FEMALE QUICK DISCONNECT TERMINAL

- Pack of 100
- 22-16 Gauge
- Insulated: 187
- Red



### IS-QD-2216-250

#### FEMALE QUICK DISCONNECT TERMINAL

- Pack of 100
- 22-16 Gauge
- Insulated: 250
- Red



**IS-QD-1614**

FEMALE QUICK DISCONNECT TERMINAL

- Pack of 100
- 22-18 Gauge
- Insulated: 187
- Blue



**22 - 18 GAUGE**

**IS-IQF-1614**

FEMALE QUICK DISCONNECT TERMINAL

- Pack of 100
- 16-14 Gauge
- Non-insulated Nylon
- Blue



**16 - 14 GAUGE**

**IS-IQF-1210**

FEMALE QUICK DISCONNECT TERMINAL

- Pack of 100
- 12-10 Gauge
- Non-insulated Nylon
- Yellow



**12 - 10 GAUGE**

**IS-QD-2218-110**

FEMALE QUICK DISCONNECT TERMINAL

- Pack of 100
- Quick Disconnect
- Red



**IS-IQM-1210NL**

NYLON MALE FULLY INSULATED  
TAB CONNECTOR

- 12-10 Gauge
- Pack of 100
- Fully Insulated .250
- Quick Disconnect
- Yellow



**12 - 10 GAUGE**

**IS-IQF-1210NL**

NYLON FEMALE QUICK  
DISCONNECT TERMINAL

- 12-10 Gauge
- Pack of 100
- Fully Insulated .250
- Quick Disconnect
- Yellow



**12 - 10 GAUGE**

**IS-IQM-1614NL**

NYLON MALE FULLY INSULATED  
TAB CONNECTOR

- 16-14 Gauge
- Pack of 100
- Fully Insulated .250
- Quick Disconnect
- Blue



**16 - 14 GAUGE**

**IS-IQF-1614NL**

NYLON FEMALE QUICK  
DISCONNECT TERMINAL

- 16-14 Gauge
- Pack of 100
- Fully Insulated .250
- Quick Disconnect
- Blue



**16 - 14 GAUGE**

**IS-IQF-2218NL**

NYLON FEMALE QUICK  
DISCONNECT TERMINAL

- 22-18 Gauge
- Pack of 100
- Fully Insulated .250
- Quick Disconnect
- Red



**22 - 18 GAUGE**

**IS-IQM-2218NL**

NYLON MALE FULLY INSULATED  
TAB CONNECTOR

- 22-18 Gauge
- Pack of 100
- Fully Insulated .250
- Quick Disconnect
- Red



**22 - 18 GAUGE**

**MALE QUICK DISCONNECT  
TERMINALS / BULLET TERMINALS**

**IS-IQM-1210**

**QUICK DISCONNECT**

- Quick disconnect male
- Full insulated nylon
- Red
- 100 pcs. x bag



**22 - 18 GAUGE**

**IS-TB-1614**

**MALE SPADE CRIMP CONNECTOR**

- Male crimp connectors suitable for 16-14AWG wires. The connectors feature vinyl insulation and form a reliable electrical connection.
- Color: Blue
- Size : 6.3mm x 0.8mm
- Material: Insulation: Vinyl, Terminal Body: Brass, Metallic Sleeve: Copper, Plating: Tin
- Pack of 100



**16 - 14 GAUGE**

**IS-TB-2216**

**MALE SPADE CRIMP CONNECTOR**

- Insulated
- Pack of 100



**22 - 16 GAUGE**

**IS-BLF-1614**

**VINYL FEMALE BULLET CONNECTOR**

- 16-14 Gauge
- Color: Blue
- Insulated: 156
- Pack of 100



**16 - 14 GAUGE**

**IS-TB-2218**

**MALE SPADE CRIMP CONNECTOR**

- Male crimp connectors suitable for 12-10AWG wires. The connectors feature vinyl insulation and form a reliable electrical connection.
- Color: Blue
- Size : 6.3mm x 0.8mm
- Material: Insulation: Vinyl, Terminal Body: Brass, Metallic Sleeve: Copper, Plating: Tin
- Pack of 100



**22 - 18 GAUGE**

**IS-TB-1012**

**MALE SPADE CRIMP CONNECTOR**

- Male crimp connectors suitable for 10-12AWG wires. The connectors feature vinyl insulation and form a reliable electrical connection.
- Color: Yellow
- Size : 6.3mm x 0.8mm
- Material: Insulation: Vinyl, Terminal Body: Brass, Metallic Sleeve: Copper, Plating: Tin
- Pack of 100



**12 - 10 GAUGE**

**MBLM-1614HS**

**MARINE HEAT SHRINK  
MALE BULLET CONNECTOR**

- 16-14 Gauge
- Color: Blue
- Translucent Vinyl Insulator
- Pack of 100



**16 - 14 GAUGE**

**IS-BLM-1614**

**VINYL MALE BULLET CONNECTOR**

- 16-14 Gauge
- Color: Blue
- Insulated
- Pack of 100



**16 - 14 GAUGE**

**IS-TFK-0**

**1/0 GAUGE WIRE FERRULES WITH HEAT SHRINK**

- Color: Black
- Insulated
- Pack of 25



**IS-TFK-4**

**4 GAUGE WIRE FERRULES WITH HEAT SHRINK**

- Color: Black
- Insulated
- Pack of 25



**MLX-8040**

**ANDERSON TYPE DC PLUG**

- 350 Amps
- 0-4 Gauge
- 2 Pole
- Each plug is a mirror of the other and are simple to assemble. There is no Male & Female. One simply connects into another of the same amperage. The plugs push together to form a very solid and reliable connection.



**GRK-110**

**175 PIECE TERMINAL KIT**

- Solderless Terminals and Connectors Kit
- Includes: Spade Terminals, Ring Terminals, Male Push-On, Female Push-On, Bullet, Hook, Butt Connector



**IS-GRK-270**

**270 PCS ASSORTED WIRING TERMINAL AND CRIMP CONNECTOR KIT**

- Red/Blue/Yellow Butt Splice Connector
- Red/Blue/Yellow Insulated Spade terminal
- Red/Blue/Yellow Insulated Ring terminal
- Red/Blue Male Insulated Quick Disconnect Terminal
- Red/Blue Female Insulated Quick Disconnect Terminal



**IS-119-5G**

**RCA FEMALE-TO-FEMALE CONNECTOR - GOLD**

- 5 Red & 5 Black Pcs



**IS-119-5SL**

**RCA FEMALE-TO-FEMALE CONNECTOR - SILVER**

- 5 Red & 5 Black Pcs



**IS-120-5G**

**RCA MALE-TO-MALE CONNECTOR - GOLD**

- 5 Red & 5 Black Pcs



**IS-120-5SL**

**RCA MALE-TO-MALE CONNECTOR - SILVER**

- 5 Red & 5 Black Pcs

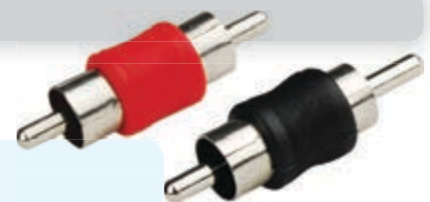

**MISCELLANEOUS CONNECTORS**

**IS-CC2214B**

**NYLON CRIMP CAP**

- 22-14 Gauge
- Long Barrel
- Black
- Pack of 100



**22 - 14 GAUGE**

**IS-CC2214N**

**NYLON CRIMP CAP**

- 22-14 Gauge
- Long Barrel
- White
- Pack of 100



**22 - 14 GAUGE**

**IS-CC1416**

**NYLON CRIMP CAP**

- 16-14 Gauge
- Long Barrel
- White
- Pack of 100



**16 - 14 GAUGE**

**IS-QS-2218**

**QUICK SPLICE ADAPTER**

- 22-18 Gauge
- Red
- Pack of 100



**22 - 18 GAUGE**

**IS-QS-1614**

**QUICK SPLICE ADAPTER**

- 16-14 Gauge
- Blue
- Pack of 100



**16 - 14 GAUGE**

**IS-QS-1210**

**QUICK SPLICE ADAPTER**

- 12-10 Gauge
- Yellow
- Pack of 100



**12 - 10 GAUGE**

**IS-TT-2218**

**T-TAP SPLICE CONNECTOR**

- 22-18 Gauge
- Red
- Pack of 100



**22 - 18 GAUGE**

**IS-TT-1614**

**T-TAP SPLICE CONNECTOR**

- 16-14 Gauge
- Blue
- Pack of 100



**16 - 14 GAUGE**

**IS-TT-1210**

**T-TAP SPLICE CONNECTOR**

- 12-10 Gauge
- Yellow
- Pack of 100



**22 - 10 GAUGE**



**CC-5**

**CABLE NAIL-IN CLIP**

- Secures coaxial cables to floors, baseboards or walls
- Corrosion and UV resistant clips
- For indoor or outdoor use
- Black
- Pack of 100



**CC-6 BLK**

**CABLE NAIL-IN CLIP**

- Secures coaxial cables to floors, baseboards or walls
- Corrosion and UV resistant clips
- For indoor or outdoor use
- Black
- Pack of 100



**IS-ATO-20 (20 amp)**

**IS-ATO-30 (30 amp)**

**IS-ATO-40 (40 amp)**

**BLADE TYPE TERMINAL CAR FUSE**

- 25 Pack
- Designed to fit regular AMP APM/ATM fuse holders
- High-temperature, impact-resistant plastic casings
- See-through windows allow for easy inspection
- Ultimate circuit protection and high conductivity plating
- Voltage Rating: 10 Volt - 32 Volt
- Fuse Dimension: 19.1 × 5.1 × 18.5 mm



These terminal car fuses are specifically designed for Cars, Trucks, SUVs, ATVs, UTVs, Camper RV, Motorcycles, Fleet, Golf Car, Boat, snowmobiles, and most general DC applications etc., covering such components as radio, light, turn signals, etc.

**IS-ATM-LP-10 (10 amp)**

**IS-ATM-LP-20 (20 amp)**

**LOW PROFILE BLADE TYPE**  
**MINI ATM FUSES**

- 25 Pack
- High-temperature, impact-resistant plastic casings
- See-through windows allow for easy inspection
- Ultimate circuit protection and high conductivity plating
- Nickel Plated Blade, Polycarbonate Housing
- Voltage Rating: 10 Volt - 32 Volt
- Fuse Dimension: 10.9 × 3.6 × 16.3 mm



**BLADE TYPE / ANL / AFC FUSES**

- IS-AST-3A (3 amp)
- IS-AST-10A (10 amp)
- IS-AST-15A (15 amp)
- IS-AST-20A (20 amp)

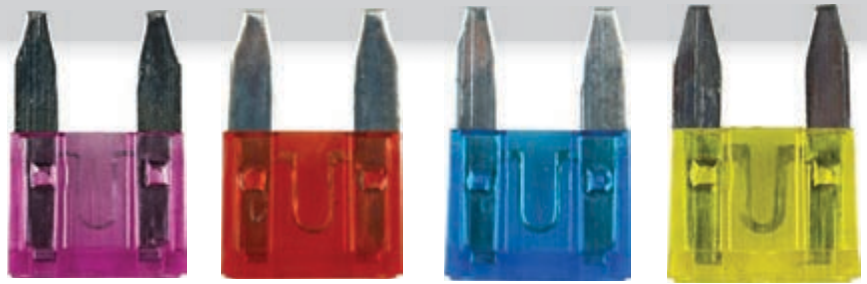

**MINI BLADE TYPE AST TERMINAL CAR FUSE**

- 25 Pack
- High-temperature, impact-resistant plastic casings
- See-through windows allow for easy inspection
- Ultimate circuit protection and high conductivity plating
- Voltage Rating: 10 Volt - 32 Volt
- Fuse Dimension: 19.1 × 5.1 × 18.5 mm

- ANL-60A (60 amp)
- ANL-80A (80 amp)
- ANL-100A (100 amp)
- ANL-150A (150 amp)
- ANL-175A (175 amp)
- ANL-200A (200 amp)
- ANL-225A (225 amp)
- ANL-250A (250 amp)
- ANL-300A (300 amp)



**ANL FUSES**

- 2 Pack ANL Fuses
- Gold Plated
- ANL fuse will protect your controller, wire, and battery from overcurrent.
- Voltage Rating: no more than 32 Volts
- Easy Installation for Multiuse Combinations

- AFC-40 (40 amp)
- AFC-50 (50 amp)
- AFC-60 (60 amp)
- AFC-80 (80 amp)
- AFC-120 (120 amp)
- AFC-150 (150 amp)



**AFC FUSES**

- 5 Pack AFC Fuses
- Nickel Plated
- Voltage 32 Volts
- These high-amp fuses are the best way to protect the investment you have in your sound system.

**AGU-40A** (40 amp)

**AGU-50A** (50 amp)

**AGU-60A** (60 amp)

**AGU-70A** (70 amp)

**AGU-80A** (80 amp)

**AGU-100A** (100 amp)

**GOLD PLATED MIDGET CAR FUSE**

- 5 Piece Blister Pack
- 10.3 x 38.10mm (13/32 x 1-1/2 inch)
- Voltage Rating: 32 V/125 V/250 V
- Replaces AGU and 4AG Fuses



**FGMAC-1** (1 amp)

**FGMAC-2** (2 amp)

**CERAMIC FUSE**

- 10 Piece Blister Pack
- 6 x 30mm Ceramic Tube
- A type of low resistance resistor that acts as a sacrificial device to provide overcurrent protection, of either the load or source circuit. Widely used for electric equipment, home appliance, and so on.



**FC-10A** (10 amp)

**FC-12A** (12 amp)

**FC-15A** (15 amp)

**FC-20A** (20 amp)

**FC-25A** (25 amp)

**FC-30A** (30 amp)

**CERAMIC FUSE**

- 10 Piece Blister Pack
- 5 x 20mm Ceramic Tube
- A type of low resistance resistor that acts as a sacrificial device to provide overcurrent protection, of either the load or source circuit. Widely used for electric equipment, home appliance, and so on.



**X-450RTF**

**DOUBLE SPEAKON**

- Double Speakon with Double 1/4" Terminal and Foam Seal
- In/Out XLR Terminal
- In/Out 1/4" Terminal
- Banana Plug/Speaker Wire Input



**X-825**

**DOUBLE SPEAKON**

- Double Speakon with Double 1/4" Terminal
- 7" x 5"
- Without Crossover



**X-870**

**DOUBLE SPEAKON**

- Double Speakon Terminal with Double 1/4" Terminal
- 7" x 5"
- With Crossover

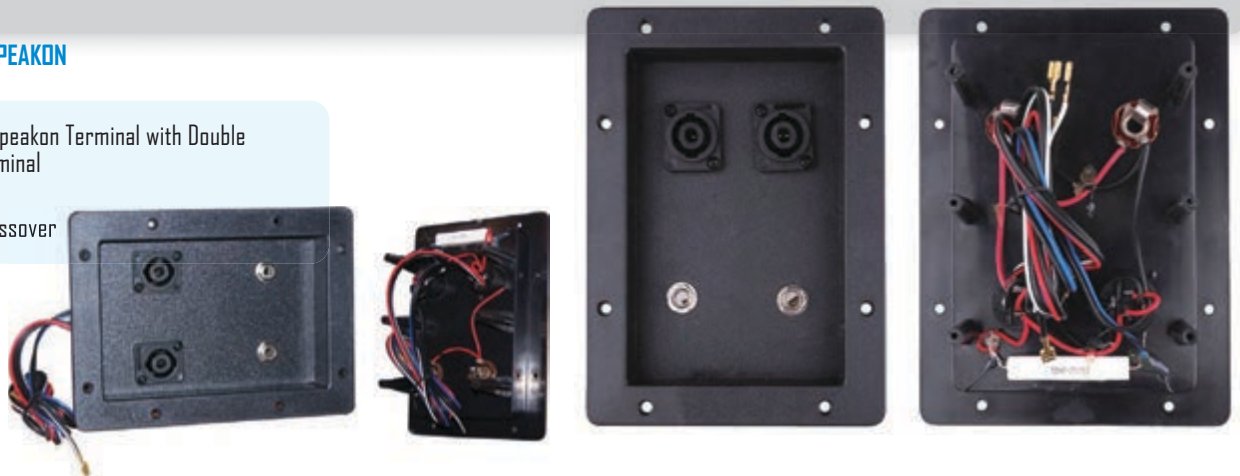

- WRS-5** (25W, 5 Ohm Resistor)
- WRS-1010** (10W, 10 Ohm Resistor)
- WRS-1015** (10W, 15 Ohm Resistor)
- WRS-2015** (20W, 15 Ohm Resistor)
- WRS-2525** (25W, 25 Ohm Resistor)
- WRS-3310** (33W, 10 Ohm Resistor)

**NON-INDUCTIVE RESISTORS**

- Audio Grade Resistors are used in Zobel Networks and fixed L-pad Attenuator Circuits for Tweeters. Nickel-Chromium Elements, a High Thermal Conductivity Ceramic Core, and Welded Construction all Contribute to their Low-Noise Performance.



- YCP-1.5** 250V 1.5uF ± 5%
- YCP-2.0** 150V 2.0uF ± 5%
- YCP-2.2** 250V 2.2uF ± 5%
- YCP-2.5** 250V 2.5uF ± 5%
- YCP-3.0** 200V 3.0uF ± 5%
- YCP-3.3** 250V 3.3uF ± 5%
- YCP-4.7** 200V 4.7uF ± 5%
- YCP-10** 250V 10uF ± 5%
- YCP-22** 250V 22uF ± 35%

**CAPACITORS**

- MYLAR Capacitors (25 PCS per unit)



<b>FM.25</b> (.25 amp)	<b>FM3</b> (3 amp)	<b>FM6.3</b> (6.3 amp)
<b>FM.5</b> (.5 amp)	<b>FM3.15</b> (3.15 amp)	<b>FM7</b> (7 amp)
<b>FM1</b> (1 amp)	<b>FM3.5</b> (3.5 amp)	<b>FM8</b> (8 amp)
<b>FM1.5</b> (1.5 amp)	<b>FM4</b> (4 amp)	<b>FM9</b> (9 amp)
<b>FM2</b> (2 amp)	<b>FM5</b> (5 amp)	<b>FM10</b> (10 amp)
<b>FM2.5</b> (2.5 amp)	<b>FM6</b> (6 amp)	<b>FM15</b> (15 amp)



**MINI GLASS FUSES**

- 100 Pieces per pack
- A type of low resistance resistor that acts as a sacrificial device to provide overcurrent protection, of either the load or source circuit. Widely used for electric equipment, home appliance, and so on.
- Voltage Rating: 250V
- Fuse Dimension: 5 x 20mm glass tube

<b>FN.5</b> (.5 amp)	<b>FN3.5</b> (3.5 amp)	<b>FN15</b> (15 amp)
<b>FN1</b> (1 amp)	<b>FN4</b> (4 amp)	<b>FN20</b> (20 amp)
<b>FN1.5</b> (1.5 amp)	<b>FN5</b> (5 amp)	<b>FN25</b> (25 amp)
<b>FN2</b> (2 amp)	<b>FN6</b> (6 amp)	<b>FN30</b> (30 amp)
<b>FN2.5</b> (2.5 amp)	<b>FN7</b> (7 amp)	
<b>FN3</b> (3 amp)	<b>FN10</b> (10 amp)	



**GLASS FUSES**

- 100 Pieces per pack
- A type of low resistance resistor that acts as a sacrificial device to provide overcurrent protection, of either the load or source circuit. Widely used for electric equipment, home appliance, and so on.
- Glass tube construction
- Fast acting - non-time delay
- Voltage Rating: 250V
- Fuse Dimension: 6 x 30mm glass tube

**HD-013**

**IN-LINE FUSE HOLDER FOR CAR STEREO**

- Standard 1-1/4" fuseholder
- Overall length 2-1/4" with 18 gauge wires



**FS-1**

**FS-2**

**SCREW CAP CHASSIS MOUNT FUSE HOLDER**

- Maximum Voltage: AC 250V
- Maximum Rated Current: 10A
- Suitable For Fuse Size: 5mm x 20mm (FS-1) 6mm x 30mm (FS-2)
- Cap: Screw type



**IS-ANL-2310**

**HEAVY DUTY ANL FUSE HOLDER**

- Clear Housing with Mounting Base
- All Metal Parts are 24kt Gold finish
- Includes a 150A ANE (ANL) fuse
- Accepts 0 to 4 Gauge Cable Wire
- Perfect Contact for Power Cable
- Set Screw Design
- No Crimping required
- Water Resistant



**IS-N2C**

**IN-LINE AGU FUSE HOLDER**

- Clear Housing with Mounting Base
- 24Kt Finish Fuse Holder
- Perfect Fit for 8 or 4 Gauge Power Cable
- Accepts AGU fuse up to 80 Amps
- Connect Base is Precision Machined
- Water Resistant



**CQ-ADCTC-16**

**ATC FUSE HOLDER**

- 10 Pcs per bag



**CQ-ADATM-16**

**ATM FUSE HOLDER**

- 10 Pcs per bag



**IS-ANLF-9310**

**IN-LINE ANL FUSE HOLDER**

- Clear Housing with Mounting Base
- 24Kt Finish Fuse Holder
- Includes 1pc 100A fuse
- Accepts 0 to 4 Gauge Cable Wire
- 1 FT (0.3M) 0Ga Red Power Cable
- Connect Base is Precision Machined
- Water Resistant



**IS-FBG-4328**

**2 POSITION AGU FUSE HOLDER**

- 24Kt Finish Fuse Holder
- One 2 Gauge or two 4GA Input and two 8 Gauge Outputs
- Inner Steps Ensure perfect recessed fits Cable into Block
- Base is Precision machined
- Includes two 60A fuses



**IS-1020**

**POWER DISTRIBUTION BLOCK**

- One 0GA or 2GA Input, Two 4GA & Two 8GA Output
- Platinum Finish



**IS-020**

**0 GAUGE COUPLER**

- Nickel Plated Finish
- Ideal for Power or Ground Cable
- Set Screw ensures Tight Connection
- Ultra Conductive



**IS-ICR1555LG**

**HEAVY DUTY COPPER TERMINAL CRIMPER TOOL**

- Cut and strip 10-22 AWG solid and stranded wire.
- Crimp 10-22AWG insulated and non-insulated terminals.
- Comfortable soft grip handle.
- Crimp coaxial connectors.
- Shear and thread common size electrical screws.
- Hole in the side of jaw for looping solid wire.
- Use pliers nose to tighten or loosen small nuts.
- Length: 15-1/4"



**IS-CR1005**

**WIRE CUTTER & CRIMPING TOOL**

- Crimps insulated and non insulated 10-22AWG
- Specialty-hardened wire cutter in nose
- Crimping Die Marked for Insulated and Non-Insulated Solderless Terminals and Connectors
- Plastic-Dipped, Cushioned Handles for Comfort
- Length: 9-1/2"



**ICR-D10**

**0 GAUGE HIGH LEVERAGE CABLE CUTTER**

- Cuts 0 AWG copper and aluminum cable
- Dropped-forged, high-carbon steel construction
- Precision-ground, hardened cutting edges provide accurate cuts without cable distortion
- Length: 9-1/4"



**IS-FCS-33**

**FLUSH-CUT MICRO SOFT-WIRE CUTTER**

- Body: 45# Steel, HRC42-51, TPR handle
- 13mm long neck angled head for flush cutting wire, resistor, capacitor, and other board mounted component legs
- Micro flush cut wire cutter with soft-wire stripper
- 5" flush cutter with stripper





**IS-FWS-33**

**MICRO TIP PCB WIRE CUTTER**

- Precision wire cutter pliers has an 11mm long jaw with angled head design for flush-cutting applications.
- Heat-treated 65# Manganese Steel (65# Mn) construction provides Durability and Long Life. Small but Sharp Flush Cutters.
- Dolphin-style nonslip grip handle has non-toxic and tasteless properties. Surfaces prevent rust and increase corrosion resistance.
- Length: 5-1/2"



**IS-FWS-66**

**FLUSH WIRE CUTTER / STRIPPER**

- Body: 50# steel, HRC42-50, PVC handle
- Wire stripping range: 10 - 20AWG / 0.8-2.6mm
- Multifunctional: This tool can be used as wire stripper also works as a wire cutter
- This flush-cut wire stripper/cutter is durable, and easy to use with its ergonomic grip handle that reduces hand fatigue.
- Length: 6-3/4"



**IS-ST1022**

**3-IN-1 WIRE STRIPPER, CRIMPER, AND CUTTER TOOL**

- Cut and strip 10-22 AWG solid and stranded wire.
- Crimp 10-22AWG insulated and non-insulated terminals.
- Comfortable soft grip handle.
- Crimp coaxial connectors.
- Shear and thread common size electrical screws.
- Hole in the side of jaw for looping solid wire.
- Use pliers nose to tighten or loosen small nuts.
- Length: 8-1/4"



**IS-IST-166A**

**DUAL WIRE STRIPPER / CUTTER FOR SOLID WIRE**

- Body: 50# steel, HRC42-50, Mango TPR
- Wire stripping range: 10-20AWG / 0.8 - 2.6mm
- Multifunctional: This tool can be used as wire stripper also works as a wire cutter
- This dual wire stripper/cutter is durable, and easy to use with its ergonomic grip handle that reduces hand fatigue. Strips two wires with one single motion and is perfect for professional or home use and can be used to cut many different materials.
- Length: 6-1/2"



**IS-NTK-400**

**SELF-ADJUSTING INSULATION WIRE STRIPPER WITH CUTTER AND CRIMPER**

- Zinc alloy head, Cr12MoV, HRC52-60°, PP & TPR handle, GS
- Wire stripping range: 24 - 10AWG / 0.2 - 6mm
- Non-insulated terminal: 12 - 10AWG / 4 - 6mm
- Non-insulated terminal: 16 - 14 AWG / 1.5 - 2.5mm
- Non-insulated terminal: 22 - 18 AWG / 0.5 - 1mm
- The jaws clamp down and automatically selects the right tension to the wire avoiding damage to the strands
- Adjustable arm can be preset to a given size so it continuously strips equally amongst multiple cables
- Length: 8"



**IS-NTK-370**

**SELF-ADJUSTING INSULATION WIRE STRIPPER WITH CUTTER AND CRIMPER**

- Zinc alloy head, Cr12MoV, HRC52-60°, PVC handle
- Wire stripping range: 24-10AWG / 0.2 - 6mm
- Insulation terminal: 22-10AWG / 0.5 - 6mm
- Non-insulated terminal: 12-10AWG / 4-6mm
- Non-insulated terminal: 22-14AWG / 0.5-2.5mm
- Ignition terminal: 7-8mm
- Stripping force adjustment knob can adjust pressure accordingly as to not damage wire strands. The jaws clamp down and automatically selects the right tension
- Length: 8-1/4"



**IS-KIT-130**

**INSULATED 3-IN-1 WIRE STRIPPER, CUTTER, AND CRIMPER**

- 50 Pcs assorted wiring terminals & connectors kit
- Length: 8"

**INCLUDES THE FOLLOWING:**

- RV1-4S (Red): Insulated copper ring terminals 22 - 16AWG x 5 pcs
- RV2-4S (Blue): Insulated copper ring terminals 16 - 14AWG x 5 pcs
- SV1-4S (Red): Insulated copper spade terminals 22 - 16AWG x 5 pcs
- SV2-4S (Blue): Insulated copper spade terminals 16 - 14AWG x 5 pcs
- 2-25D (Red): Male insulated quick disconnectors 16 - 14AWG x 5 pcs
- 2-25D (Blue): Male insulated quick disconnectors 16 - 14AWG x 5 pcs
- 2-25D (Red): Female insulated quick disconnectors 16 - 14AWG x 5 pcs
- 2-25D (Blue): Female insulated quick disconnectors 16 - 14AWG x 5 pcs
- BV1 (Red): Butt splice connectors x 5 pcs
- BV2 (Blue): Butt splice connectors x 5 pcs



**NTK-59**

**CRIMPING TOOL FOR RG-58/59**

- Designed for RG6/58/59 connectors. Allows easy connection of any connector with crimp style pin and sleeve
- This crimping tool is used for crimping network cables. Designed for professional use with cable television, home-theater, and security systems
- Steel construction with grips for comfort and accuracy
- Easy to use
- Length: 8-1/4"



**NTK-56CMP**

**WATERPROOF COMPRESSION CRIMPING TOOL**

- Profession Waterproof Connectors Crimping Tool
- The use of high-quality steel production. Exquisite workmanship, strong and durable
- Crimp range. Professional suppression RG59, 58, 6 coaxial cable F, BNC, RCA connector to ensure the quality of the suppression while showing a beautiful appearance
- Quality blade, blade sharp and easy to cut. High-quality wear-resistant blade, long life, to ensure that the cut out of the port formation, no glitches
- Convenient latch design, save time and effort, easy to suppress, incorporating simple
- The use of high-quality plastic handle Professional ergonomic concept, so you feel more comfortable when used
- Length: 8-3/4"

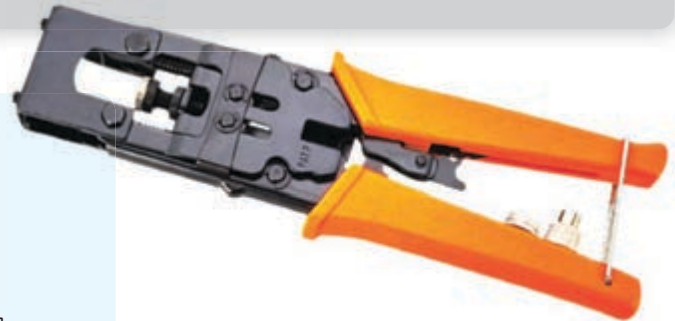

**NTK-56LCM**

**L-SHAPED COMPRESSION CRIMPING TOOL**

- The use of high-quality steel production. Exquisite workmanship, strong and durable
- Crimp range. Professional suppression RG59, 58, 6 coaxial cable F, BNC, RCA connector to ensure the quality of the suppression while showing a beautiful appearance
- Quality blade, blade sharp and easy to cut. High-quality wear-resistant blade, long life, to ensure that the cut out of the port formation, no glitches
- Length: 7-3/4"



**CRIMPING TOOLS**

**GHT-301C**

**CRIMP TOOL**

- For RG-58, 59, 62 & 6



**TTK-725**

**COMPRESSION CRIMPING TOOL**

- Professional waterproof connectors crimping tool with adjustments for crimping different lengths of "F", "BNC", and "RCA" connectors.
- Length: 5-1/2"



**KR-219S**

**MODULAR CRIMPING TOOL FOR 4P/6P/8P**

- For crimping Ethernet modular plugs 8P8C/RJ45, 6P6C/RJ-12, 6P4C/RJ-11, 4P4C and 4P2C
- Easy and efficient cutting and stripping wire with one operation
- Round cable stripper
- Lightweight, durable and compact
- Material: Middle carbon steel
- Length: 8"



**TTK-69**

**ECONOMY NETWORK LAN CABLE CRIMPER**

- 15.4" 6 to 1/0 AWG heavy duty HEX LUG / Terminal Crimper
- Length: 15.4"
- Weight: 2.9 Lbs
- Capacity: 6-50mm<sup>2</sup>
- Range of application: BS standard type terminals
- Length: 8"



**TTK-061**

**WIRE STRIPPING TOOL**

- Stripper for wire diameter 3 - 6.2mm
- Top end 110/88
- Dimensions: 90mm x 29mm x 5.4mm



**GHT-323**

**UNIVERSAL STRIPPING TOOL**

- Use on coaxial cable RG58, RG59, and RG6
- For round cable, stranded wire
- Multi-conductor cable & irregular out shape cable
- Dimensions: 98.5mm x 33.5mm x 20.7mm
- Stripping Length: This stripper can strip cable in four lengths 4, 6, 8, and 12mm. The stripping length is preset to 6mm. If you want to strip other lengths, you just need to adjust the blade's position.
- Blade's Depth: You may use the hex wrench, which is installed on the bottom of the tool to adjust the blades' depth.



**GHT-325**

**UNIVERSAL COAXIAL WIRE STRIPPING TOOL**

- Use on coaxial cable RG59, RG6, RG7 and RG11 round networking cable and telephone cable.
- Dimensions: 123mm x 71mm x 23.5mm
- Block is reversible, one side is available for RG59 and RG6, the other side is for RG7/11.



**TTK-756**

**COAX COMPRESSION CRIMPING TOOL**

- Adjustable compression tool with comfortable grip
- For use on RG59 RG6 RG11 cable F-Connector
- The tool is made of high hardness and precision material, which is light and easy to carry, durable and has a long service life.
- The handle is made of special soft rubber material, which is non-slip, comfortable to use and strong in hand feeling.
- Designed with the principle of leverage, saving effort and making the crimping press to the end.
- Length: 6-3/4"



**TTK-3756**

**PROFESSIONAL COMPRESSION TOOL**

- Adjustable compression tool with comfortable grip.
- For use on RG59, RG6, RG11, BNC, and RG11 cable F-Connector.
- The tool is made of high hardness and precision material, which is light and easy to carry, durable and has a long service life.
- The handle is made of special soft rubber material, which is non-slip, comfortable to use and strong in hand feeling.
- Designed with the principle of leverage, saving effort and making the crimping press to the end.
- Length: 6-3/4"



**TTK-021**

**IMPACT PUNCH TOOL**

- Uses 110 Blade
- Adjustable Impact Wheel
- For termination of telephone and high-speed network data cables
- Insert and cut cable terminations effortlessly
- Durable Punch Tool, makes network installation all that easy
- Impact-absorbing cushioned grip reduces operator stress for high volume installers
- Storage compartment with unique locking device provides convenient storage for spare blades



**TTK-021-RB57**

**REPLACEMENT BLADES FOR TTK-021**

- Replacement Blades for an Impact Punch Down Tool
- The Blade for Punch Down Tools is Durable and made to Last
- Easy and Simple Installation
- Fits all Standard Punch Down and Impact Tools
- Perfect for Everyday use, as a Spare, or Replacement
- Includes two replacement blades



**IDCR-132**

**T-TAP NYLON TERMINAL**

- 18-14 gauge
- Yellow
- Package of 100



**IHPM-307**

**METRIC FOLDING HEX KEY SET**

- 7 Piece folding hex key set
- 1.5mm, 2mm, 2.5mm, 3mm, 4mm, 5mm, 6mm Sizes



**IHPS-307**

**STANDARD FOLDING  
HEX KEY SET**

- 7 Piece folding hex key set
- 1/16", 5/64", 3/32", 1/8", 5/32", 3/16", 7/32" Sizes



**IMPU-175**

**TELESCOPING 6.5**

- Magnetic Pick Up Tool 6 1/2



**PJ-06**

**6 PIECE PRECISION  
SCREWDRIVER SET**

- Screwdriver Set featuring 6 different sized heads
- Includes Phillips #1 and #0 along with Flat-head 1.4mm, 2.0mm, 2.4mm, and 3.0mm
- Set includes convenient carry case



**GTK-174**

**PRECISION  
SCREWDRIVER SET**

- Screwdriver set 7 Pieces



**PJ-11**

**11 PIECE PRECISION  
SCREWDRIVER SET**

- Screwdriver Set featuring 6 different sized heads
- Includes Phillips #1 and #0 along with Flat-head 1.4mm, 2.0mm, 2.4mm, and 3.0mm
- Set includes convenient carry case



**IUPH-700**

**7 PIECE UPHOLSTERY REMOVAL TOOL KIT**

- Easily and safely to remove radio panel, trim, molding, door panels, and dashboards.
- Great for automotive snap on trim panel and molding removal.
- Reduce the concave and protruding scars left by using screw knife or other non-efficient tools.
- High quality rugged design that made of durable plastic.
- Work on interior and exterior trim, wide edge remover, handle remover or upholstery clip remover.



**GSD-140**

**11 PIECE 105 DEGREE ANGLE DRIVER BIT SET**

- Gears are mounted in a die-cast with 3 durable ball bearings
- Strong built-in magnetic socket holds standard hex drilling and drive bits; prevents falling
- 105-degree designs for tight spaces
- Hex bit holder socket extends the power of a cordless screwdriver
- Handy tool for hard-to-reach areas
- This screwdriver bit holder can connect a hand drill and manual wrench
- Includes 7 drill bits



**TNT-BAG**

**TOOL BELT**

- 1" Web belt with quick release buckle for easy fit
- Front pocket easily fits most tapes
- Designed for tool storage
- 12 pockets
- Made of durable material



**IS-IUB-016**

**HSS TIN STEP DRILL BIT**

- Drill Size: 3/16" - 1/2"
- Perfect for cutting through multiple sheets of soft metals, plastic.
- Titanium nitride (Tin) coating lengthens tool life by conducting heat away from the cutting edge.
- Self-starting punch-style tip.
- Drill faster with less effort.
- Sturdy HSS construction.

**3/16" - 1/2"**  
**DRILL SIZE**

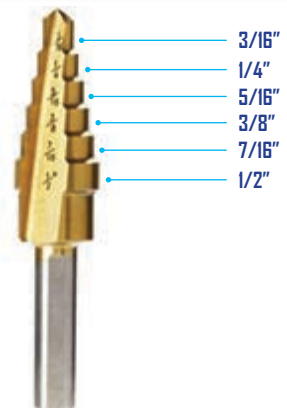



**IS-IUB-018**

**HSS TIN STEP DRILL BIT**

- Drill Size: 1/8" - 1/2"
- Perfect for cutting through multiple sheets of soft metals, plastic, veneer and thin steel.
- Titanium nitride (Tin) coating lengthens tool life by conducting heat away from the cutting edge.
- Self-starting punch-style tip.
- Drill faster with less effort.
- Sturdy HSS construction.

**1/8" - 1/2"**  
**DRILL SIZE**

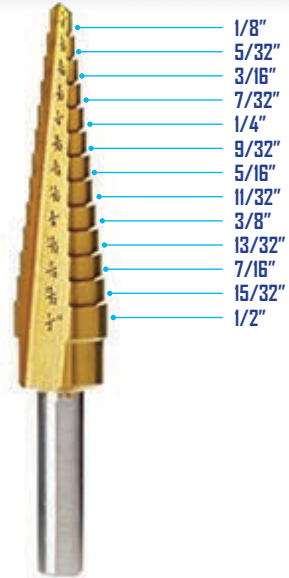

**IS-IUB-020**

**HSS TIN STEP DRILL BIT**

- Drill Size: 1/4" - 3/4"
- Perfect for cutting through multiple sheets of soft metals, plastic, veneer and thin steel.
- Titanium nitride (Tin) coating lengthens tool life by conducting heat away from the cutting edge.
- Self-starting punch-style tip.
- Drill faster with less effort.
- Sturdy HSS construction.

**1/4" - 3/4"**  
**DRILL SIZE**

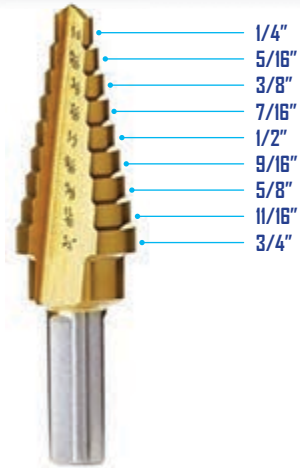

**IS-KEY9**

**9 PIECE OEM RADIO REMOVAL KEY KIT**

- Includes 9 different pairs of key
- Storage bag conveniently stores the keys
- Kit includes 18 specially designed tools and keys that are a must for removing stereos and cd players flawlessly.
- Never attempt to remove a car audio system with everyday tools, auto manufacturers use special tools to prevent stereo theft. Without these special tools, damage can occur to the head unit or surrounding area of the dashboard.
- Engineered with durable stainless steel construction to prevent cracking, stripping and undue wear and tear.



## POLYOLEFIN HEAT SHRINK TUBING

### HTSK-0400-RL50

#### POLYOLEFIN HEAT SHRINK TUBING

- 2:1 Shrink Ratio
- Flame Retardant, VW-1
- Shrink Temp: 70°C (158°F)
- Operating Temp: -55°C thru 125°C (-67°F thru 257°F)



### HTSK-0200-RL100 (02-00 GAUGE)

### HTSK-1612-RL100 (16-22 GAUGE)

### HTSK-2018-RL100 (20-18 GAUGE)

### HTSK-2422-RL100 (24-22 GAUGE)

### HTSK-2826-RL100 (28-26 GAUGE)

#### POLYOLEFIN HEAT SHRINK TUBING - 100 FOOT ROLL

- 2:1 Shrink Ratio
- Flame Retardant, VW-1
- Shrink Temp: 70°C (158°F)
- Operating Temp: -55°C thru 125°C (-67°F thru 257°F)



This thin wall, heat shrink tubing is made from a specially formulated, cross-linked polyolefin. This tough, flexible, flame retardant tubing can be used for electrical insulation, wire bundling, color coding, lightweight harnessing, wire strain relief, and wire identification purposes in a variety of home, commercial, industrial and military applications. 2:1 heat shrink tubing slides easily over small inline splices and connectors, and shrink down to 50% of its original diameter to fit snugly over any wire, hose or cable management project.

### HTSK-0200 (02-00 GAUGE)

### HTSK-0400 (04-00 GAUGE)

### HTSK-1612 (16-22 GAUGE)

### HTSK-2018 (20-18 GAUGE)

### HTSK-2422 (24-22 GAUGE)

### HTSK-2826 (28-26 GAUGE)

#### POLYOLEFIN HEAT SHRINK TUBING - 8 PIECES

- 2:1 Shrink Ratio
- Flame Retardant, VW-1
- Shrink Temp: 70°C (158°F)
- Operating Temp: -55°C thru 125°C (-67°F thru 257°F)
- Tube Length: 6"



**HTSK-100CL**

**POLYOLEFIN HEAT SHRINK TUBING VALUE PACK**

- 2:1 Shrink Ratio
- Flame Retardant, VW-1
- Shrink Temp: 70°C (158°F)
- Operating Temp: -55°C thru 125°C (-67°F thru 257°F)
- 02-00 Gauge (White): 4 Quantity
- 04-00 Gauge (Blue): 6 Quantity
- 16-12 Gauge (Green): 10 Quantity
- 20-18 Gauge (Red): 20 Quantity
- 24-22 Gauge (Yellow): 30 Quantity
- 28-26 Gauge (Black): 30 Quantity
- Tube Length: 6"



**LM-14-100 BLK** 1/4" Diameter 100 feet

**LM-38-100 BLK** 3/8" Diameter 100 feet

**LM-1-20 BLK** 1/2" Diameter 20 feet

**LM-12-100 BLK** 1/2" Diameter 100 feet

**LM-34-100 BLK** 3/4" Diameter 100 feet

**LM-1-100 BLK** 1" Diameter 100 feet

**LM-115-100 BLK** 1 1/2" Diameter 100 feet



**BLACK POLYETHYLENE SPLIT LOOM TUBING**

- Color: Black
- Material: High quality Polyethylene
- Split design flexible ribbed tube design for clean and easy install
- Used to protect electrical wiring in automotive, marine, hydraulic, home office and other applications
- Resistant to abrasions, gasoline, oil, and other harmful chemicals

**SBL-12-50-BLK** 1/2" Diameter 50 feet

**SBL-34-50-BLK** 3/4" Diameter 50 feet

**SBL-1-50-BLK** 1" Diameter 50 feet

**SELF-WRAPPING BRAIDED SPLIT LOOM**

- Length: 50 Feet
- Color: Black
- Material: Semi rigid braided construction
- The wire sleeve is made with a flexible split design and easy to load wires. A perfect choice for cable management
- Once loaded, our cable sleeve will close on itself and perfectly wrap cables
- Protects and prolongs the life of wires. Economical and easy to install



**CABLE SLEEVES**

**IS-BR6M-100BLK**

**IS-BR6M-100BLU**

**EXPANDABLE BRAIDED CABLE SLEEVE**

- Diameter: 1/4"
- Length: 100 Feet
- Material: PET
- Diameter expands up to 150%
- Cable sleeving protects and prolongs the life of wires
- Operating temp (degree F): 103 - 257
- Melt temp (degree F): 446

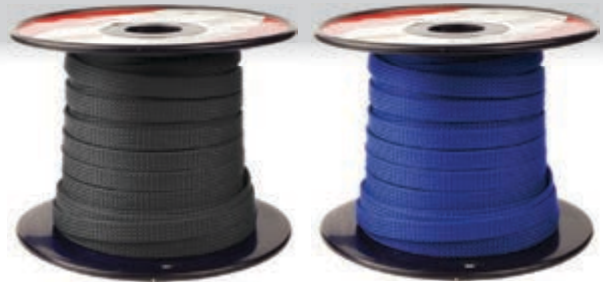

**1/4"**  
**DIAMETER**

**IS-BR10M-100BLK**

**IS-BR10M-100BLU**

**IS-BR10M-100RD**

**EXPANDABLE BRAIDED CABLE SLEEVE**

- Diameter: 3/8"
- Length: 100 Feet
- Material: PET
- Diameter expands up to 150%
- Cable sleeving protects and prolongs the life of wires
- Operating temp (degree F): 103 - 257
- Melt temp (degree F): 446

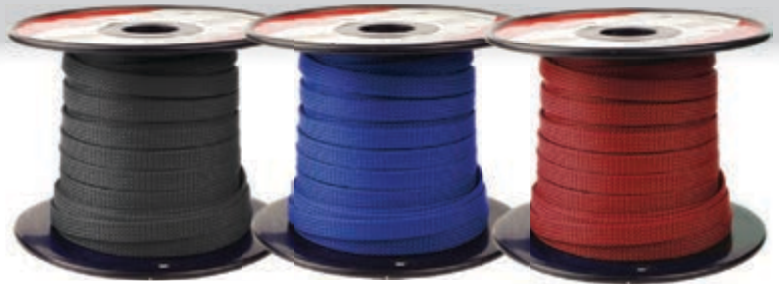

**3/8"**  
**DIAMETER**

**IS-BR19M-100BLK**

**IS-BR19M-100BLU**

**IS-BR19M-100RD**

**IS-BR19M-100GR**

**EXPANDABLE BRAIDED CABLE SLEEVE**

- Diameter: 3/4"
- Length: 100 Feet
- Material: PET
- Diameter expands up to 150%
- Cable sleeving protects and prolongs the life of wires
- Operating temp (degree F): 103 - 257
- Melt temp (degree F): 446



**3/4"** **DIAMETER**



**CABLE TIES**

<b>IS-CT-4BUV</b> 4" 18 lbs	<b>IS-CT-12BUV</b> 12" 40 lbs
<b>IS-CT-6BUV</b> 6" 18 lbs	<b>IS-CT-14BUV</b> 14" 50 lbs
<b>IS-CT-8BUV</b> 8" 40 lbs	<b>IS-CT-16BUV</b> 14" 55 lbs
<b>IS-CT-10BUV</b> 10" 40 lbs	

**BLACK UV RESISTANT NYLON CABLE TIES**

- (100 Pieces)
- UV Resistant
- Black



<b>IS-CT-4</b> 4" 18 lbs	<b>IS-CT-12</b> 12" 50 lbs
<b>IS-CT-6</b> 6" 18 lbs	<b>IS-CT-14</b> 14" 50 lbs
<b>IS-CT-8</b> 8" 40 lbs	<b>IS-CT-16</b> 16" 50 lbs
<b>IS-CT-10</b> 10" 40 lbs	

**WHITE NYLON CABLE TIES**

- Color: White
- 5mm Width
- Material: Nylon
- Self-locking
- High tensile strength and a high degree of flexibility
- Wide use, perfect for home, office, garage, garden, or whenever you need sort out your different wires, zippers and other accessories
- 100 Piece bag



<b>US-CT-4BUV</b> 4" 18 lbs	<b>US-CT-10BUV</b> 10" 40 lbs
<b>US-CT-6BUV</b> 6" 18 lbs	<b>US-CT-11BUV</b> 11" 50 lbs
<b>US-CT-7BUV</b> 7" 40 lbs	<b>US-CT-12BUV</b> 12" 50 lbs
<b>US-CT-8BUV</b> 8" 40 lbs	<b>US-CT-14BUV</b> 14" 50 lbs

**BLACK UV RESISTANT NYLON CABLE TIES**

- Color: Black
- Material: UV Stabilized Nylon 6-6 Material
- Operating Temperature Range -40°F to +185°F
- High Resistance To Sun & Outdoor Exposure
- Self Locking Design, Saves Hands From Abrasion
- High tensile strength and a high degree of flexibility
- Wide use, perfect for home, office, garage, garden, or whenever you need sort out your different wires, zippers and other accessories
- 100 Piece bag



**US-CTR-8BUV**

**BLACK UV RESISTANT CABLE TIES WITH MOUNTING RING**

- Length: 8"
- Tensile Strength: 40 lbs
- Color: Black
- 5mm Width
- Material: UV Stabilized Nylon 6-6 Material
- High Resistance To Sun & Outdoor Exposure
- Self Locking Design, Saves Hands From Abrasion
- Wide range of uses, good for keeping all kinds of cords cables well organized and tidy in place
- 100 Piece bag



**IS-VLR6BLK**

**ADJUSTABLE VELCRO CABLE TIE**

- Length: 6"
- Color: Black
- Reusable, durable, flexible fabric material
- Detachable design is convenient to use
- High tensile strength and a high degree of flexibility
- Great for computer, appliance, and electronics wire management
- 10 Piece bag



**NST-012B 1/2"**

**NST-034B 3/4"**

**#8 SELF-TAP TRUSS HEAD SCREW**

- 1000 Piece bag
- Color: Black



**NSCP-012 1/2"**

**NSCP-01 1"**

**#8 MEDIUM THREAD PAN HEAD SCREW**

- 100 Piece bag
- Color: Black



**NSCW-012 1/2"**

**NSCW-01 1"**

**#8 DEEP THREAD WAFER HEAD SCREW**

- 1000 Piece bag
- Color: Black



**NSCD-012**

**SCREW OVAL HEAD**

- Length: 1/2"
- 100 Piece bag
- Color: Black



**NSCD-516**

**#8 SCREW OVAL HEAD**

- 5/16" #8 Thread Countersink Screw
- 1000 Piece bag

**NSCO-012**

**#8 MEDIUM COUNTERSINK  
HEAD SCREW**

- Length: 1/2"
- 100 Piece bag
- Color: Black



**NSCO-014**

**#8 MEDIUM COUNTERSINK  
HEAD SCREW**

- Length: 1/4"
- 100 Piece bag
- Color: Black



**GG-833F**

**HOT GLUE GUN**

- 10 Watts
- 110V, 60Hz
- Built-in safety features such as an insulated nozzle and a fuse for peace of mind while the stand makes it easy to work with and stand up on your table when not in use.
- Great for all DIY, arts/crafts, home projects, home repair, Electronics, Dioramas, Models, Toy Repair, Wood Bonding and more
- Uses 1/4" diameter glue stick



**GG-839F**

**HOT GLUE GUN**

- 80 Watts
- 120V, 60Hz
- Built-in safety features such as an insulated nozzle and a fuse for peace of mind while the stand makes it easy to work with and stand up on your table when not in use.
- Great for all DIY, arts/crafts, home projects, home repair, Electronics, Dioramas, Models, Toy Repair, Wood Bonding and more
- Uses 1/2" diameter glue stick



**GS-1110BLK**

**10" HOT GLUE STICKS**

- 10 Pieces
- Diameter: 1/2"
- Length: 10"
- Black Color



**GS-1051-10**

**10" HOT GLUE STICKS**

- For GG-839F glue gun
- 10 Pieces
- Diameter: 1/2"
- Length: 10"

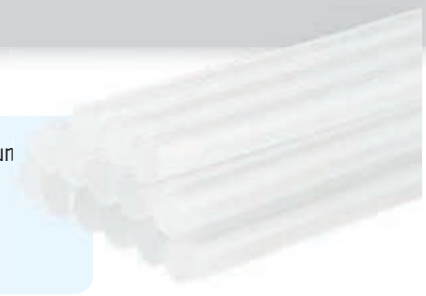

**GS-675**

**HOT GLUE STICKS**

- For GG-833F glue gun
- 135 Pieces
- Diameter: 1/4"
- Length: 4"



**GS-610**

**HOT GLUE STICKS**

- For GG-839F glue gun
- 48 Pieces
- Diameter: 1/2"
- Length: 4"



**GS-720BL**

**HOT GLUE STICKS**

- For GG-833F glue gun
- 6 Pieces
- Diameter: 1/4"
- Length: 4"



**GS-1120BL**

**HOT GLUE STICKS**

- For GG-839F glue gun
- 6 Pieces
- Diameter: 1/2"
- Length: 4"



**SA-8012**

**FOAM & FABRIC SPRAY ADHESIVE**

- Wide Web Spray Pattern
- Temporary or Permanent Bonds
- No CFC's or Ozone Depleters
- No Chlorinated Solvents
- Professional and Industrial Use
- 12 Oz (340 grams)



**SB-8101**

**FLEXIBLE COATING FOR SOUND  
DEADENING & PROTECTION**

- High Density, Low weight compounds
- Greatly Reduces Road Noise & Panel Vibrations
- Clings to Wood, Plastic, Metal & Fiberglass
- Weatherproof, Can Be Used Inside or Outside of Vehicle



**IS-SPGT-25G**

**EPOXY ADHESIVE (BLACK)**

- 3-5 minute handling time
- 8-10 minute set time
- 1 hour cure time
- Net volume: 0.85 Fl. Oz. (25ml)
- A two part, black color, rapid curing general purpose epoxy. Better on more rigid materials. Useful in repairing metals, wood, plastic, tile, ceramic, fiberglass, PVC, concrete and more. May also be used as a metal filler and to restore rotten wood. You can add color pigment to epoxy after thoroughly mixing.



**IS-EPXY-20G**

**EPOXY ADHESIVE (BLACK)**

- 3-5 minute handling time
- 8-10 minute set time
- 1 hour cure time
- Volume: 0.35 Oz (10g) - Hardener  
0.35 Oz (10g) - Resin  
0.70 Oz (20g) - Total
- Epoxy adhesive quickly bonds and repairs metals, wood, plastic, tile, ceramic, fiberglass, PVC, concrete and more!



**TGP-450-20G**

**THERMAL GREASE (WHITE)**

- 2.15w/m-k 20g
- Quick cooling
- Non-toxic, environmental protection
- Good heat dissipation
- Stable performance
- High temperature resistance
- Thermal grease, also called thermal paste or thermal compound, is a substance used to promote better heat conduction between two surfaces and is commonly used between a microprocessor and a heatsink.

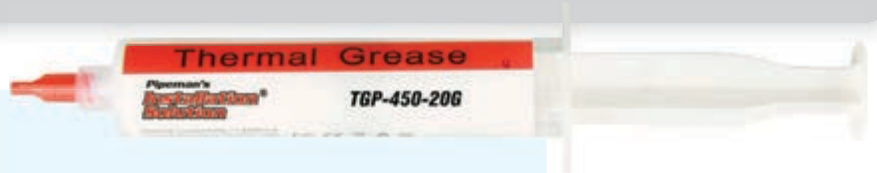

**TGPH-550-20G**

**THERMAL GREASE (GREY)**

- 2.7w/m-k 20g tube packing with OEM label
- Quick cooling
- Non-toxic, environmental protection
- Good heat dissipation
- Stable performance
- High temperature resistance
- Thermal grease, also called thermal paste or thermal compound, is a substance used to promote better heat conduction between two surfaces and is commonly used between a microprocessor and a heatsink.





- |                |                |
|----------------|----------------|
| ET-12 (Blue)   | ET-16 (Brown)  |
| ET-13 (Red)    | ET-17 (Grey)   |
| ET-14 (Green)  | ET-18 (White)  |
| ET-15 (Yellow) | ET-19 (Orange) |



**7 MIL VINYL ELECTRICAL TAPE**

- 3/4" x 60 Feet
- Rugged construction premium quality vinyl 7 mil thickness provides superior adhesion while insulating and protecting
- Resistant to sun, oil, acids, alkalies, and corrosive chemicals
- Suitable for use at no more than 600 volts as primary insulation and not more than 80°C (176°F); UL and CSA listed for consumer confidence adding peace of mind to safety and quality concerns

**ET-5**

**7 MIL VINYL ELECTRICAL TAPE**

- 3/4" x 12 Feet
- Resistant to sun, oil, acids, alkalies, and corrosive chemicals
- Suitable for use at no more than 600 volts as primary insulation and not more than 80°C (176°F); UL and CSA listed for consumer confidence adding peace of mind to safety and quality concerns
- Black



**ET-11**

**7 MIL VINYL ELECTRICAL TAPE**

- 3/4" x 60 Feet
- Rugged construction premium quality vinyl 7 mil thickness provides superior adhesion while insulating and protecting
- Resistant to sun, oil, acids, alkalies, and corrosive chemicals
- Suitable for use at no more than 600 volts as primary insulation and not more than 80°C (176°F); UL and CSA listed for consumer confidence adding peace of mind to safety and quality concerns



**ET-20 MULTI**

**7 MIL VINYL ELECTRICAL TAPE**

- 3/4" x 60 Feet
- Rugged construction premium quality vinyl 7 mil thickness provides superior adhesion while insulating and protecting
- Resistant to sun, oil, acids, alkalies, and corrosive chemicals
- Suitable for use at no more than 600 volts as primary insulation and not more than 80°C (176°F); UL and CSA listed for consumer confidence adding peace of mind to safety and quality concerns



**ET-1060-DST**

**1" DOUBLE SIDED FOAM TAPE**

- 1" x 60"
- Works on many surfaces including metal, glass and plastic
- Holds up to 5 lbs. One inch holds a quarter pound four inches hold one pound
- Weather resistant and highly conformable
- Great for indoor and outdoor use

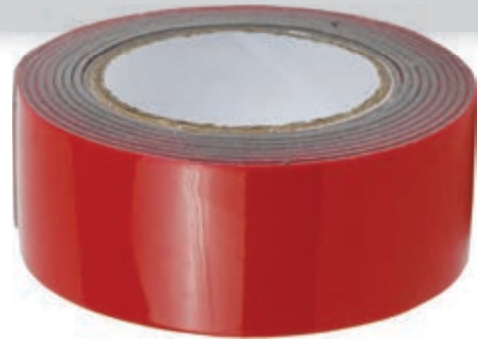

**ET-1260-DST**

**1/2" DOUBLE SIDED FOAM TAPE**

- 1/2" x 60"
- Works on many surfaces including metal, glass and plastic
- Holds up to 5 lbs. One inch holds a quarter pound four inches hold one pound
- Weather resistant and highly conformable
- Great for indoor and outdoor use

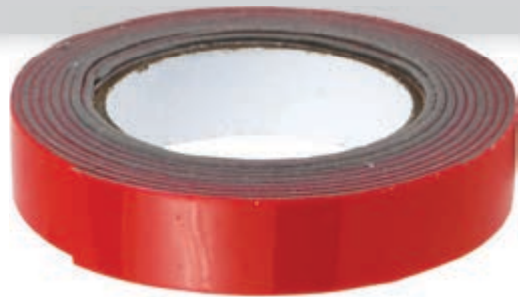

**IS-FAST1**

**1" HOOK AND LOOP FASTENING SYSTEM**

- Nylon hooks mesh with pliable loops for fast, secure closure.
- Maximum convenience - just press to close and peel to open.
- Adhesive backing adheres instantly to many surfaces
- Black color
- Self adhering
- 1" wide



**IS-FAST2**

**2" HOOK AND LOOP FASTENING SYSTEM**

- Nylon hooks mesh with pliable loops for fast, secure closure.
- Maximum convenience - just press to close and peel to open.
- Adhesive backing adheres instantly to many surfaces
- Black color
- Self adhering
- 2" wide



**TNT-SQ35MAH**

**5" PRO HANDLE SQUEEGE**

- Removes over 95 percent of standing water
- With non-slip comfortable embowed grip handle
- Ergonomic soft edge handle with medical grade silicone blade will not scratch
- 5 inch flexible silicone blade
- Perfect for windows, mirrors, and large flat surfaces



**TNT-SQ35SF**

**3.75" SILICONE BLADE SQUEEGEE**

- Removes over 95 percent of standing water
- Durable hard plastic handle with medical grade silicone blade will not scratch
- 3.75 inch flexible silicone blade
- Perfect for windows, mirrors, and large flat surfaces



**TNT-SQ35H**

**5.5" SILICONE BLADE SQUEEGEE**

- Removes over 95 percent of standing water
- Durable hard plastic handle with medical grade silicone blade will not scratch
- 3.5 inch flexible silicone blade
- Perfect for windows, mirrors, and large flat surfaces



**TNT-SQ55**

**5.5" SILICONE BLADE SQUEEGEE**

- Removes over 95 percent of standing water
- Durable hard plastic handle with medical grade silicone blade will not scratch
- 5.5 inch flexible silicone blade
- Perfect for windows, mirrors, and large flat surfaces

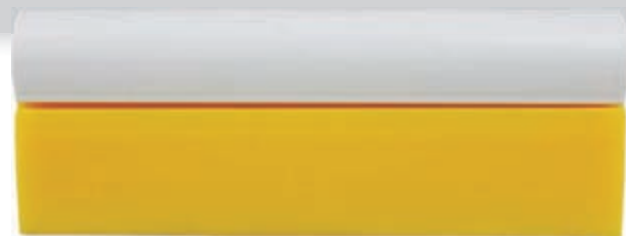

**TNT-SQ29M**

**HARD MINI SQUEEGEE**

- The TNT-SQ29M is used by window film installers, tinters, to get the water out of tight spots
- It's a tough & hard little squeegee, hard card. It's a must have tool for any tinter
- Great for scraping and installation/removal of vinyl wraps
- Endless uses: Smooth Caulking and Putty, Auto Detailing, Signs & Scrapbooks
- Great for lifting photo pieces off the cutting mat instead of using your finger nail



This is the best vinyl film installation tool ever! They are razor thin along the edges, allowing you to safely lift, scrape and remove vinyl film without scratching a variety of surfaces. Used by: auto detailers, painters, sign shops, warehouses, body shops, scrap-bookers and MORE

**TNT-SQ11M**

**HARD CREDIT CARD SQUEEGEE**

- Blue Color
- This vinyl squeegee tool can be widely used as window tint squeegee, window tint scraper, car wrap squeegee, vinyl sticker & decal applicator, window film install kit
- This window tinting squeegee is a tough & hard little squeegee, hard card. It is perfect for all vinyl applications and will not scratch during installation
- Endless uses: Smooth Caulking and Putty, Auto Detailing, Signs & Scrapbooks Great for lifting photo pieces off the cutting mat instead of using your finger nail
- Used by: Auto detailers, painters, sign shops, warehouses, body shops, scrap-bookers and MORE



**TNT-SQ22S**

**PRO AUTO APPLICATION TOOL**

- The squeegee has a rubber edge designed to remove application fluid and clean prior to application
- Three in one squeegee that aides in installation of precut and tint film rolls.
- Soft Squeegee Blade Along I Edge & Point Hard-card Tips On the Ends
- This is an installation tool recommended for DIY installers to achieve professional results.



**CRI-09**

**INSTALLATION ROD**

- 9" Back Strap Car Radio

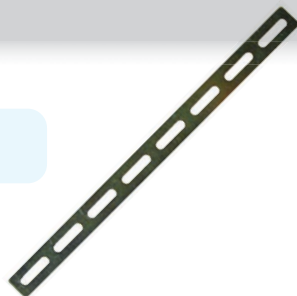

**CRI-16**

**INSTALLATION ROD**

- 16" Back Strap Car Radio

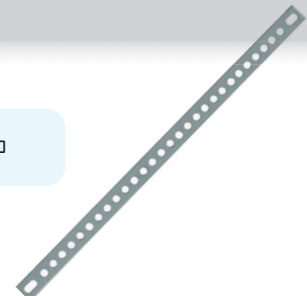

**GTD-1200**

**HEAT GUN**

- Power: 750/1500W
- Voltage: 110V AC
- Frequency: 60 Hz
- Perfect for applying window tint film, stripping paint, varnish, thawing metal pipes, drying paint plaster, heating shrink tubing, shaping, and bonding plastic and pipe connections
- Lightweight and compact design for ease of use and handling

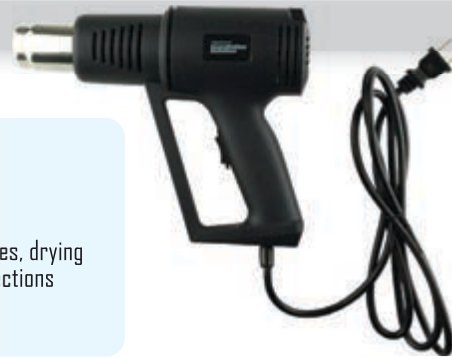

**TNT-SPP42**

**42 OZ PRESSURIZED WATER PUMP SPRAYER**

- Multi-functional compression sprayer for indoor and outdoor use This sturdy sprayer is suitable for lawn and garden. Additional applications include car cleaning and maintenance. This product is suitable for spraying water up to 131°F
- Adjustable brass nozzle, ergonomic locking handle and pressure release valve
- Use for plant, flower, garden and lawn care, auto wheels, windows and exterior body



**TNT-SC10010-SB**

**REPLACEMENT BLADE**

- 1Box = 100 pcs



**TNT-KN09**

**AUTO LOCK UTILITY KNIFE SPRAYER**

- Sleek, light weight stainless steel handle
- Slide lock for convenient one hand operation
- 9mm wide blade
- Safety auto lock feature
- With built-in blade snapper and pocket clip
- Designed for right and left handed use
- This stylish slim knife is ideal for free hand precision trimming jobs such as vinyl sign cutting. Great tool for manually debarring edges for a clean finish. Rust resistant, high grade stainless steel holder will extend the life of your snap off blade knife even in damp conditions



**TNT-KN1210-SB**

10 PIECE replacement  
BLADES available  
separately



**402A-285G**

**CHEMICAL DUSTER FOR ELECTRONICS**

- 10 Oz. super duster
- Removes microscopic dust, lint and foreign particles
- Cleans computers and keyboards, photographic and audio-video equipment, coin counters, printers timing devices, cash machines, optical equipment, fax machines and other electro mechanical instruments
- High rate of flow delivery systems for increased performance
- ROHS compliant



**409B-140G**

**ZERO RESIDUE ELECTROSOLVE CONTACT CLEANER**

- MG Chemical's MGC-409B Electrosolve Contact Cleaner is a powerful and effective cleaning tool that rapidly penetrates and dissolves many types of soil. This is the perfect cleaner when zero residue contact is required for clear connections. This product is flammable and so caution must be used.
- Easy to use, degreases quickly, removes grease, tar, adhesives and fluxes
- Enhances equipment performance by removing contaminants
- Great for cleaning connectors, contacts, LED's, PCB's, circuit breakers, tuners and microprocessors
- The variable rate of speed valve allows the user to control the amount of spray used



**419C-340G**

**CHEMICALS CONFORMAL COATING**

- MG Chemicals Conformal Coatings are used to resist electrical arcing and protect against mold, moisture, solvents, scratching, static discharge, and physical force. MG Chemicals offers a wide range of Conformal Coatings for the protection of circuit boards, windings and coils, transformers, field coils, and stator windings.
- Super fast cure—tack free in about 3 min; full cure in <30 min at 65 °C [149 °F]
- Protects electronics from moisture, corrosion, fungus, and static discharges
- Excellent finish—smooth, homogeneous, and durable crystal clear coat



**824-450G**

**ISOPROPYL ALCOHOL AEROSOL ELECTRONICS CLEANER**

- An economical safe on plastics electronics cleaner and flux remover, it is safe on plastics, has a moderate evaporation rate, and is non-corrosive.
- Dissolves light oils and residues on electronic devices and equipment
- Zero residue
- Food safe - Registered with NSF for use in and around food processing establishments
- Perfect for cleaning de-energized electronics components and equipment, connectors and contacts, printed circuit boards, switches and relays, semi-conductors, magnetic heads, laser lenses in optical drives and office medical equipment
- Removes greases, oils, inks, rosin flux residues, and organic contaminants



**824-500ML**

**ISOPROPYL ALCOHOL LIQUID SPRAY ELECTRONICS CLEANER**

- An economical safe on plastics electronics cleaner and flux remover, it is safe on plastics, has a moderate evaporation rate, and is non-corrosive.
- Dissolves light oils and residues on electronic devices and equipment
- Zero residue
- Food safe - Registered with NSF for use in and around food processing establishments
- Perfect for cleaning de-energized electronics components and equipment, connectors and contacts, printed circuit boards, switches and relays, semi-conductors, magnetic heads, laser lenses in optical drives and office medical equipment
- Removes greases, oils, inks, rosin flux residues, and organic contaminants



- CPT-150 GRY 
- CPT-150 BLK 
- CPT-150 BLU 
- CPT-150 PL (Platinum) 
- CPT-150 RED 

**TRUNK & SPEAKER BOX LINER**

- 4 x 150 foot roll
- Good sound insulation material for low frequency and high frequency sound and can effectively inhibit the propagation of various vibrations
- Used as sound insulation material in cars,

theaters, concert halls, museums, exhibition halls, library, interrogation room, gallery, auction hall, gymnasium, lecture hall, multipurpose hall, hotel lobby, conference room, studio, recording room, KTV rooms, bars, industrial plants, room, and in the home



- CPT-450 GRY 
- CPT-450 BLK 
- CPT-450 PL (Platinum) 

**TRUNK & SPEAKER BOX LINER**

- 4 x 15 foot roll
- Good sound insulation material for low frequency and high frequency sound and can effectively inhibit the propagation of various vibrations
- Used as sound insulation material in cars,

theaters, concert halls, museums, exhibition halls, library, gallery, auction hall, gymnasium, lecture hall, multipurpose hall, hotel lobby, conference room, studio, recording room, KTV rooms, bars, industrial plants, room, and in the home



- CPT-650 GRY 
- CPT-650 BLK 
- CPT-650 PL (Platinum) 

**TRUNK & SPEAKER BOX LINER**

- 6 x 150 foot roll
- Good sound insulation material for low frequency and high frequency sound and can effectively inhibit the propagation of various vibrations
- Used as sound insulation material in cars,

theaters, concert halls, museums, exhibition halls, library, interrogation room, gallery, auction hall, gymnasium, lecture hall, multipurpose hall, hotel lobby, conference room, studio, recording room, KTV rooms, bars, industrial plants, room, and in the home



- CPT-FLE 145
- FLEECE BACKING FOR FIBERGLASS**

- 4 x 15 Feet
- Blue



- GCF-6036 BLK 
- GCF-6036 TAN 

**SPEAKER GRILL CLOTH**

- 3 x 5 Feet
- Open weave grill cloth is virtually 100% acoustically transparent. Will not muffle or color sound



**VENTED ENCLOSURES**

**BVE-112C**

**SINGLE 12" VENTED ENCLOSURE**

- Dark Grey MDF Carpeting Material
- Face MDF Thickness: 3/4"
- Overall MDF Thickness: 5/8"
- Speaker Mounting Depth: 15-1/2"
- Speaker Hole Diameter: 11"
- Tuning Frequency: 41 Hz
- Gross Cubic FT per side: 2 ft<sup>3</sup>
- Vent Dimensions (LxWxH): 2." x 14" x 13-1/4"
- Dimensions (LxWxH): 18" x 16 x 13-1/4"

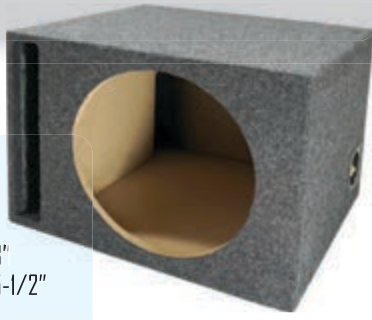

**BVHD-112C**

**SINGLE 12" VENTED**

- Dark Grey MDF Carpeting Material
- Face MDF Thickness: 3/4"
- Overall MDF Thickness: 5/8"
- Speaker Mounting Depth: 12"
- Speaker Hole Diameter: 11"
- Tuning Frequency: 41 Hz
- Gross Cubic FT per side: 2 ft<sup>3</sup>
- Vent Dimensions (LxWxH): 2-1/4" x 12-3/4" x 13-1/4"
- Dimensions (LxWxH): 18" x 16" x 13-1/4"



**BVE-210C**

**DUAL 10" VENTED ENCLOSURE**

- Dark Grey MDF Carpeting Material
- Face MDF Thickness: 3/4"
- Overall MDF Thickness: 5/8"
- Speaker Mounting Depth: 14-11/16"
- Speaker Hole Diameter: 9-1/8"
- Tuning Frequency: 41 Hz
- Gross Cubic FT per side: 1.2 ft<sup>3</sup>
- Vent Dimensions (LxWxH): 2.5" x 11-1/4" x 11-3/4"
- Dimensions (LxWxH): 29-3/4" x 15 x 11-3/4"



**BVE-212C**

**DUAL 12" VENTED ENCLOSURE**

- Dark Grey MDF Carpeting Material
- Face MDF Thickness: 3/4"
- Overall MDF Thickness: 5/8"
- Speaker Mounting Depth: 15-15/16"
- Speaker Hole Diameter: 11-1/32"
- Tuning Frequency: 41 Hz
- Gross Cubic FT per side: 1.4 ft<sup>3</sup>
- Vent Dimensions (LxWxH): 2.5" x 13-1/2" x 13-1/2"
- Dimensions (LxWxH): 30-1/8" x 17-3/8" x 13-5/8"





**BVE-215C**

**DUAL 15" VENTED ENCLOSURE**

- Dark Grey MDF Carpeting Material
- Face MDF Thickness: 3/4"
- Overall MDF Thickness: 5/8"
- Speaker Mounting Depth: 16-15/16"
- Speaker Hole Diameter: 13-15/16"
- Tuning Frequency: 41 Hz
- Gross Cubic FT per side: 1.5 ft<sup>3</sup>
- Vent Dimensions (LxWxH): 2.5" x 11-1/4" x 11-3/4"
- Dimensions (LxWxH): 35-3/8" x 16-3/8" x 15-7/8"



**BVHD-210C**

**HEAVY DUTY DUAL 10" "L" VENTED ENCLOSURE WITH 1" FACE**

- Dark Grey MDF Carpeting Material
- Face MDF Thickness: 1"
- Overall MDF Thickness: 3/4"
- Speaker Mounting Depth: 13-5/8"
- Speaker Hole Diameter: 9-1/8"
- Tuning Frequency: 42 Hz
- Gross Cubic FT per side: 1.3 ft<sup>3</sup>
- Vent Dimensions (LxWxH): 2.5" x 10-3/8" x 11-7/8"
- Dimensions (LxWxH): 31-7/8" x 14-1/8" x 11-3/4"



**BVHD-212C**

**HEAVY DUTY DUAL 12" "L" VENTED ENCLOSURE WITH 1" FACE**

- Dark Grey MDF Carpeting Material
- Face MDF Thickness: 1"
- Overall MDF Thickness: 3/4"
- Speaker Mounting Depth: 15-5/8"
- Speaker Hole Diameter: 11-1/32"
- Tuning Frequency: 42 Hz
- Gross Cubic FT per side: 1.5 ft<sup>3</sup>
- Vent Dimensions (LxWxH): 3" x 11-7/8" x 13-1/16"
- Dimensions (LxWxH): 35-7/8" x 16-1/8" x 13-1/8"



**BVHD-212C**

**HEAVY DUTY DUAL 12" "L" VENTED ENCLOSURE WITH 1" FACE**

- Dark Grey MDF Carpeting Material
- Face MDF Thickness: 1"
- Overall MDF Thickness: 3/4"
- Speaker Mounting Depth: 15-5/8"
- Speaker Hole Diameter: 11-1/32"
- Tuning Frequency: 42 Hz
- Gross Cubic FT per side: 1.5 ft<sup>3</sup>
- Vent Dimensions (LxWxH): 3" x 11-7/8" x 13-1/16"
- Dimensions (LxWxH): 35-7/8" x 16-1/8" x 13-1/8"





**AUDIO**

***2022 CATALOG***





## HORN

### NTX-1007PZ

3 3/4" X 2 3/4" PLASTIC SUPER HORN TWEETER

- Frequency Range: 3K~30KHz
- Power RMS/Max: 37.5/75W
- Impedance: 4-8 Ohms
- Mounting Diameter: 85mm x 39mm

3 3/4" x 2 3/4"  
75 Watts



### NTX-1015PZ

2X5 PIEZO 75W TWEETER

- Frequency Range: 3K~40KHz
- Power RMS/Max: 37.5/75W
- Impedance: 4-8 Ohms
- Mounting Diameter: 121mm x 43mm

2" x 5"  
75 Watts



### NTX-1150DPZ

11" X 5" DUAL WIDE DRIVER DISPERSION PLASTIC HORN

- Frequency Response: 3K-20 KHz
- Power 150 Watts
- Impedance 4-8 Ohms

11" x 5"  
150 Watts



### NTX-1405PZ

15-1/4" X 5" WIDE DISPERSION PLASTIC HORN

- Frequency Range: 3.5K~20KHz
- Power RMS/Max: 75/150W
- Impedance: 4-8 Ohms
- Mounting Diameter: 347mm x 96mm

15-1/4" x 5"  
150 Watts



### NTX-3007 NKL (Nickel) / NTX-3007PZ (Black)

3-1/2" X 7-1/2" PLASTIC TWEETER

- Frequency Range: 1.800K~30KHz
- Power RMS/Max: 60/120W
- Impedance: 4-8 Ohms
- Mounting Diameter: 157mm x 53mm

3 1/2" x 7 1/2"  
120 Watts



### NTX-3009PZ

3" X 9" PLASTIC CELLULAR HORN

- Frequency Range: 3K~30KHz
- Power RMS/Max: 60/120W
- Impedance: 4-8 Ohms
- Mounting Diameter: 197mm x 65mm

3" x 9"  
120 Watts





## HORN

### NTX-362

3" X 5" DOUBLE WIDE DISPERSION PLASTIC TWEETER

- Frequency Range: 3K~25KHz
- Power RMS/Max: 75/150W
- Impedance: 4-8 Ohms
- Mounting Diameter: 163mm x 95mm

3" x 5"  
150 Watts



### NTX-371PZ

3-1/2" X 3-1/2" PLASTIC SUPER HORN TWEETER

- Frequency Range: 4K~27KHz
- Power RMS/Max: 75/150W
- Impedance: 4-8 Ohms
- Mounting Diameter: 88mm x 88mm

3 1/2" x 3 1/2"  
150 Watts



### NTX-401PZ

4" X 11" TWEETER

- Frequency Range: 3K~30KHz
- Power RMS/Max: 60W
- Impedance: 4-8 Ohms
- Mounting Diameter: 85mm

4" x 11"  
60 Watts



### NTX-413

PROFESSIONAL HORN

- Frequency Range: 500K~11KHz
- Power RMS/Max: 100/200W
- Impedance: 8 Ohm
- Mounting Diameter: 270mm x 110mm

? x ?  
200 Watts



### NTX-417

4" X 10" HORN 180W

- Frequency Range: 500K~11KHz
- Power RMS/Max: 100/200W
- Impedance: 4-8 Ohms
- Mounting Diameter: 270mm x 100mm x 196mm

4" x 10"  
200 Watts



### NTX-105045PZ

PIEZO TWEETER

- Frequency Range: 3.5K~20KHz
- Power RMS/Max: 75/150W
- Impedance: 4-8 Ohms
- Mounting Diameter: 165mm x 112mm

? x ?  
150 Watts





## HORN

### NTX-110110

SQUARE HORN 11" x 11"

- Throat: 1-1/12"
- Type: Bolt-On
- Mounting Diameter: 212 x 212mm



**BOLT**  
on

### NTX-1111

SQUARE HORN 11" x 11"

- Throat: 1-1/12"
- Type: Bolt-On
- Mounting Diameter: 212 x 212mm



**BOLT**  
on

### NTX-1407

HORN 7" X 13-3/4" X 8-1/2" DEEP

- Throat: 1-3/8" (34mm)
- Type: Screw-On with Metal Thread
- Mounting Diameter: 320mm x 140mm



**SCREW**  
on

### NTX-1425

PLASTIC HORN WITHOUT DRIVER

- Throat: 1" (25mm)
- Type: Metal Socket for Solid Fitting
- Mounting Diameter: 105.7mm x 105.7mm



**SCREW**  
on

### NTX-1450

IRON HORN WITHOUT DRIVER

- Compact Size, Flat Front
- Aluminum Exponential Horn
- 50mm (2") Throat
- 45° x 45° Nominal Coverage



**BOLT**  
on



# HORN

## NTX-145IPL

IRON HORN WITHOUT DRIVER

- Compact Size, Flat Front
- Polished Edge
- Aluminum Exponential Horn
- 50mm (2") Throat
- 45° x 45° Nominal Coverage



**BOLT**  
on

## NTX-0714

SQUARE HORN 7 1/4" X 7 1/4"

- Throat: 1-1/2" (240mm)
- Type: Bolt-On for Solid Fitting
- Mounting Diameter: 150mm x 150mm



**BOLT**  
on

## NTX-0714SCR

SQUARE HORN 7 1/4" X 7 1/4"

- Throat: 1-3/8" (33mm)
- Type: Copper Thread Screw
- Mounting Diameter: 147mm x 148mm



**SCREW**  
on

## NTX-1466

SQUARE HORN 5-1/2" X 6-1/4" X 4-1/2"

- Throat: 2" (50mm)
- Type: Screw-On with Metal Thread
- Mounting Diameter: 158mm x 140mm



**SCREW**  
on

## NTX-1711

HORN WITHOUT DRIVER

- Throat: 1-1/2" (38)
- Type: Screw-On/Bolt-On with Accessories Included
- Mounting Diameter: 432mm x 385mm



**BOLT**  
on

**SCREW**  
on



# HORN

## NTX-1810

### LARGE LIP HORN 18"X10"

- Throat: 1-3/8" (34mm)
- Type: Screw-On with Metal Thread
- Mounting Diameter: 463mm x 243mm



SCREW ON

## NTX-410CML

### TWO TONE ABS HORN

- Throat: 1-3/8" (34mm)
- Type: Screw-On with Plastic Thread
- Mounting Diameter: 265mm x 112mm



SCREW ON

## NTX-6464-WV

### 3" X 9" PLASTIC CELLULAR HORN

- Frequency Range: 3K~30KHz
- Power RMS/Max: 60/120W
- Impedance: 4-8 Ohms
- Mounting Diameter: 197mm x 65mm



BOLT ON

## NTX-77M

### PLASTIC HORN W/ METAL THREAD

- Dimensions: 7.5" x 6" x 5" (LxWxH)
- Metal Thread Throat



SCREW ON

## NTX-515

### 5 X 15 HORN WITH METAL SOCKET

- Throat: 1-3/8" (34mm)
- Type: Screw-On with Metal Thread
- Mounting Diameter: 388mm x 130mm

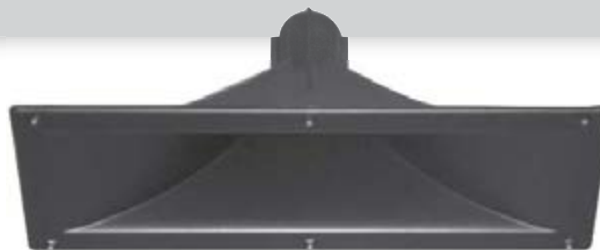

SCREW ON



## HORN

### NTX-5565

#### 5.5" X 6.5" ABS PLASTIC HORN

- Throat: 1" (26.5mm)
- Type: Bolt-On
- Mounting Diameter: 100mm x 125mm



**BOLT ON**

### NTX-6080

#### 6" X 8" ABS PLASTIC HORN

- Throat: 1" (26.5mm)
- Type: Bolt-On
- Mounting Diameter: 160mm x 120mm



**BOLT ON**

### NTX-617

#### HORN 6" X 17" WITH LARGE LIP

- Throat: 1-3/8" (34mm)
- Type: Screw-On with Metal Thread
- Mounting Diameter: 194mm x 154mm



**SCREW ON**

### NTX-6170

#### BIG HORN 6" X 17" NO LIP

- Throat: 1-3/8" (34mm)
- Type: Screw-On with Metal Thread
- Mounting Diameter: 418mm x 160mm



**SCREW ON**

### NTX-7095

#### 7" X 9.5" ABS PLASTIC HORN

- Throat: 1" (26.5mm)
- Type: Bolt-On
- Mounting Diameter: 190mm x 140mm



**BOLT ON**





## HORN / DRIVERS

### NTX-76

#### PLASTIC HORN 7" X 6"

- Throat: 1-1/4" (31mm)
- Type: Screw-On with Metal Thread
- Mounting Diameter: 194mm x 154mm



SCREW  
ON

### NTX-917

#### 9" X 17" HORN WITH 2" HOLE & 1

- Throat: 1-3/8" and includes 2" Adapters
- Type: Bolt-On
- Mounting Diameter: 348.5mm x 75mm



BOLT  
ON

### NTX-BN

#### ABS HORN FLARE W/ 2" THROAT

- Throat: 2"
- Type: Bolt-On
- Mounting Diameter: 260mm x 140mm



BOLT  
ON

### NDX-1225

#### COMPRESSION DRIVER

- Maximum Power: 100W
- Frequency Range: 2K-21KHz
- Impedance: 8 Ohms



100 Watts

### NDX-1312

#### 12 OZ. DRIVER TITANIUM DIAPHRAGM

- Voice Coil: 1-1/4" (34.4mm)
- Impedance: 8 Ohms
- Power 200W
- Diameter: 1" (25.4mm)
- Mount Screw: 1-3/8" (1cm)
- D.C. Resistance: 5.8
- Sensitivity: 102dB/W/m
- 100W RMS
- Frequency: 1500-20KHz
- Density: 1.5T
- Net Weight: 0.74Kg
- Measurement: 105mm x 76 mm



200 Watts



## DRIVERS

### NDX-3540

#### 300 WATTS DRIVER

- Voice Coil: 1-1/2" (38mm) Aluminum
- Impedance: 8 Ohms
- Magnet: 40 Oz.
- Power RMS/Max: 150/300W
- Mounting Diameter: 34mm



300 Watts

### NTX-4000USA

#### HIGH-GRADE DYNAMIC DRIVER

- Voice Coil: 2" (51mm) Aluminum
- Impedance: 8 Ohms
- Power RMS/Max: 250/500W
- Mounting Diameter: 90mm



500 Watts

### NDX-6720

#### 20 OZ. DRIVER

- Voice Coil: 1-1/2" (38mm) Aluminum
- Impedance: 8 Ohms
- Magnet: 20 Oz.
- Power RMS/Max: 175/350W
- Mounting Diameter: 34mm



350 Watts  
NSDV-6720  
Replacement Coil

### NTD-100

#### PIEZO DRIVER SMALL

- Frequency Response: 3.5-20KHz
- Impedance: 4-8 Ohms
- Power RMS/Max: 37.5/75W



75 Watts

### NTD-300

#### PIEZO DRIVER LARGE

- Frequency Response: 1.5-22KHz
- Impedance: 4-8 Ohms
- Power RMS/Max: 50/100W



100 Watts

### NTD-350

#### PIEZO DRIVER LARGE

- Frequency Response: 1.5-22KHz
- Impedance: 4-8 Ohms
- Power RMS/Max: 50/100W



100 Watts



## TWEETERS

### NTX-1800LBR

#### 4" SILVER BULLET SUPER TWEETER

- Frequency Range: 5K~20KHz
- Power RMS/Max: 100/200W
- Impedance: 4 - 8 Ohms
- Mounting Diameter: 54mm
- Blue Light



200 Watts

### NTX-1800LMR

#### 4" SILVER BULLET SUPER TWEETER

- Frequency Range: 5K~20KHz
- Power RMS/Max: 100/200W
- Impedance: 4 - 8 Ohms
- Mounting Diameter: 54mm
- Multicolor



200 Watts

### NTX-1900BR

#### SUPER BULLET TWEETER

- Frequency Range: 5k~20KHz
- Power RMS/Max: 150/300W
- Impedance: 4 - 8 Ohms
- Mounting Diameter: 53mm
- Blue Light



300 Watts

### NTX-1900SS

#### SUPER BULLET TWEETER

- Frequency Range: 5k~20KHz
- Power RMS/Max: 150/300W
- Impedance: 4 - 8 Ohms
- Mounting Diameter: 51mm
- Silver Light



300 Watts

### NTXL-44R

#### 4" TWEETER FLASHING RED LIGHT AT HIGH SOUND

- Frequency Range: 2K~20KHz
- Power RMS/Max: 75/150W
- Impedance: 4 - 8 Ohms
- Mounting Diameter: 65mm
- Red Light



150 Watts

### NTXL-44BL

#### 4" TWEETER FLASHING BLUE LIGHT AT HIGH SOUND

- Frequency Range: 2K~20KHz
- Power RMS/Max: 75/150W
- Impedance: 4 - 8 Ohms
- Mounting Diameter: 65mm
- Blue Light



150 Watts



## TWEETERS

### NTX-1005RPZ

3 3/4" HORN CHROME TRIM

- Frequency Range: 5k~20KHz
- Power RMS/Max: 75/150W
- Impedance: 4-8 Ohms
- Mounting Diameter: 66mm
- Black Light

3 3/4"  
150 Watts



### NTX-1004EP

ELECTRIC PIEZO TWEETER 3 1/4" X 3 1/4"

- Frequency Range: 4K~27KHz
- Power RMS/Max: 30/60W
- Impedance: 4-8 Ohms
- Mounting Diameter: 76mm

3 1/4" x 3 1/4"  
150 Watts



### NTX-1004PZ

PIEZO TWEETER 3 1/4" X 3 1/4"

- Frequency Range: 4K~20KHz
- Power RMS/Max: 30/60W
- Impedance: 4-9 Ohms
- Mounting Diameter: 76mm

3 1/4" x 3 1/4"  
60 Watts



### NTX-1006PZG

ROUND PIEZO TWEETER W/ GRILL

- Frequency Range: 2K~20KHz
- Power RMS/Max: 75/150W
- Impedance: 4-8 Ohms
- Mounting Diameter: 66mm

2.6" x 2.6"  
150 Watts



### NTX-1011GR

SUPER HIGH PIEZO 80W TWEETER

- Frequency Range: 5K~20KHz
- Power RMS/Max: 75/150W
- Impedance: 4-8 Ohms
- Mounting Diameter: 50mm

1.97" x 1.97"  
150 Watts





## TWEETERS

### NTX-1033PZ

#### PIEZO TWEETER 3" SQUARE

- Frequency Range: 5K~20KHz
- Power RMS/Max: 75/150W
- Impedance: 4-8 Ohms
- Mounting Diameter: 58mm

2.3" x 2.3"  
150 Watts



### NTX-3004 (Plastic)

#### TITANIUM SUPER TWEETER 250W

- Frequency Range: 3K~20KHz
- Power RMS/Max: 125/250W
- Impedance: 4-8 Ohms
- Mounting Diameter: 126mm

?"  
150 Watts



### NTX-3535PZ

#### 3.5" X 3.5" TWEETER

- Frequency Range: 2.3K~20KHz
- Power RMS/Max: 75/150W
- Impedance: 4-8 Ohms
- Mounting Diameter: 73mm

3.5" x 3.5"  
150 Watts



### NTX-4545PZ

#### 4.5" X 4.5" TWEETER

- Frequency Range: 2K~20KHz
- Power RMS/Max: 75/150W
- Impedance: 4-8 Ohms
- Mounting Diameter: 85mm

4.5" x 4.5"  
150 Watts



### NTX-IS

#### 2" SQUARE TWEETER 20W

- Frequency Response: 2K-18KHz
- Power: 20W
- Impedance: 8 Ohms
- Mounting Diameter: Ø66.5-4-4.5\*6.5

2"  
20 Watts





**TWEETERS / VOICE COIL**

**NTX-2S**

**2.5" SQUARE SPEAKER**

- Frequency Response: 2K-18k Hz
- Power RMS/Max: 10/20W
- Impedance: 8 Ohms
- Mounting Diameter: Ø74-4-4.5\*7

**2.5"**  
**20 Watts**



**NTX-3R**

**3.5" ROUND SPEAKER**

- Frequency Response: 2K-18K Hz
- Power RMS/Max: 10/20W
- Impedance: 8 Ohms
- Mounting Diameter: Ø89-4-Ø5

**3.5"**  
**20 Watts**



**NSDV-1215**

**VOICE COIL**

- Replacement Voice Coil for DRVP-1215



**NSDV-1520**

**VOICE COIL**

- Replacement Voice Coil for DRVP-1520



**NSDV-2020**

**VOICE COIL**

- Replacement Voice Coil for DRVP-2020





## ADAPTERS / VOICE COILS

### NSDV-2040

#### VOICE COIL

- Replacement Voice Coil for DRVP-2040



### VC-CM15-48

#### VOICE COIL

- Coil Diameter: Ø1.5"
- Material of Coil: KSV
- Mounting Diameter: Ø3.1"
- Height of the Coil: 0.22"

#### Replacement for:

NDX-6720  
NDX-6740



### DRAD-100

#### DRIVER ADAPTER

- Adapter Converts following Applications:
  - Bolt-On Type Compression Driver to Screw Type Horn
  - Screw Type Compression Driver to Bolt-On Type Horn



### DRVAD-1520

#### DRIVER ADAPTER

- Driver Adapter 1 3/8" for 1" Diameter





## P.A. HORN SPEAKER

### NAD-60

#### 60 WATTS DRIVER UNIT IVORY

- Frequency Response: 180-5000Hz
- RMS/Max Power: 60/120W
- Impedance: 16 Ohms
- Voice Coil: 51.6mm (2") Til

120 Watts



### NAD-100

#### 100 WATTS DRIVER UNIT IVORY

- Frequency Response: 180-500Hz
- RMS/Max Power: 100/200W
- Impedance: 16 Ohms
- Voice Coil: 51.6mm (2") Til

200 Watts



### TD-200

#### DRIVER UNIT

- Frequency Response: 160-6000Hz
- RMS/Max Power: 150/300W
- Impedance: 16 Ohms
- Voice Coil: 66KSV

300 Watts



### TD-60

#### DRIVER UNIT

- Frequency Response: 180-5000Hz
- RMS/Max Power: 60/120W
- Impedance: 16 Ohms
- Voice Coil: 51.6mm (2") Til

120 Watts



### TD-100

#### DRIVER UNIT

- Rated Input: 100W RMS. / 200W Max
- Impedance: 16 Ohm
- S.P.L. (1W/M): 110 dB
- Frequency Response: 180-5000 Hz
- Voice Coil: 51.6mm (2") til
- Magnet: 120 x 60 x 20 mm

200 Watts







# ADAPTERS / VOICE COILS

## U-60

VOICE COIL FOR P.A. DRIVERS

- Replacement Diaphragm for TDD-100

60 W



## U-100F

VOICE COIL FOR P.A. DRIVERS

- Replacement Diaphragm for TDD-100

100 W



## U-100F DD

VOICE COIL FOR P.A. DRIVERS

- Replacement Diaphragm for TDD-100

100 W



## U-200

VOICE COIL FOR P.A. DRIVERS

- Replacement Voice Coil for TD-200

200 W



## U-55S

VOICE COIL

- Replacement Voice Coil for SI-55S



## U-77S

VOICE COIL

- Replacement Voice Coil for SI-77S





## MIDRANGES / SPEAKERS

### NMG-510

5" MIDRANGE 60 WATTS

- Frequency Response: 1K-15KHz
- Power RMS/Max: 12.5/25W
- Impedance: 8 Ohms
- Mounting Diameter: Ø135-4-Ø4.5

25 Watts



### NWX-4002

4" WOOFER

- Frequency Response: 130-8KHz
- Power RMS/Max: 15/45W
- Impedance: 8 Ohms
- Mounting Diameter: Ø117-2-6.5\*12

45 Watts



### NWX-4013CR

4" PAPER CONE SPEAKER

- Frequency Response: 160-16000Hz
- Power RMS/Max: 15/45W
- Impedance: 4 Ohms
- Mounting Diameter: Ø117-2-6.5\*12

45 Watts



### NMG-612

6" MIDRANGE 70 WATTS

- Frequency Response: 800-10KHz
- Power RMS/Max: 35/70W
- Impedance: 8 Ohms
- Mounting Diameter: Ø166-4-Ø4.2

70 Watts



### NMG-818

8" MIDRANGE 90 WATTS

- Frequency Response: 600-10KHz
- Power RMS/Max: 45/90W
- Impedance: 8 Ohms
- Mounting Diameter: Ø211.5-6-Ø4.8

90 Watts





## SPEAKERS

### NWX-403-4

4" WOOFER 50 WATTS

- Frequency Response: 120-16000Hz
- Power RMS/Max: 25/50W
- Impedance: 4 Ohms
- Mounting Diameter: Ø117-4-5\*7

50 Watts



### NWX-416-4

4" WOOFER 70 WATT 1" AL VOICE C

- Frequency Response: 90-14000Hz
- Power RMS/Max: 35/70W
- Impedance: 4 Ohms
- Mounting Diameter: Ø115-4-5\*7

70 Watts



### NWX-416-8

4" WOOFER 70 WATT 1" AL VOICE C

- Frequency Response: 90-14000Hz
- Power RMS/Max: 35/70W
- Impedance: 4 Ohms
- Mounting Diameter: Ø115-4-5\*7

70 Watts



### NWX-516-8SQ

4" PAPER CONE

- Frequency Response: 65-12000Hz
- Power RMS/Max: 50/100W
- Impedance: 8 Ohms
- Mounting Diameter: Ø138-4-5.5\*8

100 Watts



### NWX-520-4SQ

4" PAPER CONE

- Frequency Response: 70-7000Hz
- Power RMS/Max: 100/200W
- Impedance: 4 Ohms
- Mounting Diameter: 138\*4-5.5\*8

200 Watts





**SPEAKERS**

**NWX-613-4**

**6" PAPER CONE**

- Frequency Response: 85Hz-12000Hz
- Power RMS/Max: 12.5/25W
- Mounting Diameter: 157\*4-5\*8

**25 Watts**



**NWX-612-4**

**6" FOAM EDGE PAPER CONE**

- Frequency Response: 85Hz-12000Hz
- Power RMS/Max: 32.5/65W
- Impedance: 4 Ohms
- Mounting Diameter: 157\*4-5\*8

**65 Watts**



**NWX-612-8**

**6" FOAM EDGE PAPER CONE**

- Frequency Response: 85Hz-12000Hz
- Power RMS/Max: 32.5/65W
- Impedance: 8 Ohms
- Mounting Diameter: 157\*4-5\*8

**65 Watts**



**NWX-616-4 (4 Ohms) / NWX-616-8 (8 Ohms)**

**6.5" PAPER CONE**

- Frequency Response: 85Hz-12000Hz
- Power RMS/Max: 40/80W
- Mounting Diameter: 157\*4-5\*8

**80 Watts**



**NWX-620-4 (4 Ohms) / NWX-620-8 (8 Ohms)**

**6.5" PAPER CONE**

- Frequency Response: 70-8KHz
- Power RMS/Max: 40/80W
- Mounting Diameter:  $\Phi$ 144MM

**80 Watts**





## SPEAKERS / WOOFERS

### NWX-820-4 (4 Ohms) / NWX-820-8 (8 Ohms)

#### 6.5" PAPER CONE

- Frequency Response: 70-8KHz
- Power RMS/Max: 40/80W
- Mounting Diameter:  $\Phi$ 144MM

80 Watts



### NWX-623-8

#### 6.5" PAPER CONE

- Frequency Response: 70Hz-13000Hz
- Power RMS/Max: 65/130W
- Impedance: 8 Ohms
- Mounting Diameter: 156\*4-5.8

130 Watts



### NWX-832C

#### 8" PAPER CONE

- Frequency Response: 70Hz-13000Hz
- Power RMS/Max: 100/200W
- Impedance: 4 Ohms
- Mounting Diameter: 213\*4-4.5

200 Watts



### NSCE-620

#### WOOFER WITH 1" ALUMINUM VOICE COIL

- 6" Paper Cone with Cloth Edge
- Frequency Response: 70-10000 Hz
- Magnet Weight: 20 Oz.
- Sensitivity: 86 dB
- Voice Coil Size: 1" ASV
- Max Power: 250W
- Impedance: 8 Ohms

250 Watts



### NSCE-830

#### WOOFER WITH 1" ALUMINUM VOICE COIL

- 8" Paper Cone with Cloth Edge
- Frequency Response: 50-5000 Hz
- Magnet Weight: 30 Oz.
- Sensitivity: 89 dB
- Voice Coil Size: 1" ASV
- Max Power: 350W
- Impedance: 8 Ohms

350 Watts





## WOOFERS / SUBWOOFERS

### NSCE-1040

#### 10" WOOFER WITH 2" ALUMINUM VOICE COIL

- 10" Paper Cone with Cloth Edge
- Frequency Response: 50-4500 Hz
- Magnet Weight: 40 Oz.
- Sensitivity: 88 dB
- Voice Coil Size: 2" ASV
- Max Power: 425W
- Impedance: 8 Ohms

425 Watts



### NSCE-1250

#### WOOFER WITH 2" ALUMINUM VOICE COIL

- 12" Paper Cone with Cloth Edge
- Frequency Response: 35-5000 Hz
- Magnet Weight: 50 Oz.
- Sensitivity: 92 dB
- Voice Coil Size: 2" ASV
- Max Power: 500W
- Impedance: 8 Ohms

500 Watts



### NSCE-1550

#### WOOFER WITH 2" ALUMINUM VOICE COIL

- 12" Paper Cone with Cloth Edge
- Frequency Response: 35-5000 Hz
- Magnet Weight: 50 Oz.
- Sensitivity: 92 dB
- Voice Coil Size: 2" ASV
- Max Power: 500W
- Impedance: 8 Ohms

500 Watts



### NWX-655

#### 6" HIGH-POWERED SUBWOOFER

- 150 Watts Max Power
- 75 Watts Rated Power
- Frequency Response: 45-4800Hz
- Sensitivity: 89 dB
- 1" 2-Layer Single Voice Coil ASV
- Rigid Steel Basket
- Mounting Depth: 74mm (3")
- Impedance: 8 Ohms
- 20 Oz. Magnet

150 Watts





## SUBWOOFERS

### NWX-855

#### 8" HIGH-POWERED SUBWOOFER

- 200 Watts Max Power
- 100 Watts Rated Power
- Frequency Response: 40-5000Hz
- Sensitivity: 89 dB
- 1" 2-Layer Single Voice Coil ASV
- Rigid Steel Basket
- Mounting Depth: 88mm (3-1/2")
- Impedance: 8 Ohms
- 20 Oz. Magnet

200 Watts



### NWX-1055

#### 10" HIGH-POWERED SUBWOOFER

- 350 Watts Max Power
- 175 Watts Rated Power
- Frequency Response: 35-4000Hz
- Sensitivity: 90 dB
- 1.5" 2-Layer Single Voice Coil ASV
- Rigid Steel Basket
- Mounting Depth: 107mm (4-1/4")
- Impedance: 8 Ohms
- 33 Oz. Magnet

350 Watts



### NWX-1255-8

#### 15" HIGH-POWERED SUBWOOFER

- 450 Watts Max Power
- 225 Watts Rated Power
- Frequency Response: 30-3500Hz
- Sensitivity: 90dB
- 1.5" 2-Layer Single Voice Coil ASV
- Rigid Steel Basket
- Mounting Depth: 4 3/4"
- Impedance: 8 Ohms
- 33 Oz Magnet

450 Watts



### NWX-1555

#### 15" HIGH-POWERED SUBWOOFER

- 500 Watts Max Power
- 250 Watts Rated Power
- Frequency Response: 27-3000Hz
- Sensitivity: 91 dB
- 2" 2-Layer Single Voice Coil ASV
- Rigid Steel Basket
- Mounting Depth: 153mm (6")
- Impedance: 8 Ohms
- 38 Oz. Magnet

500 Watts





## WOOFERS

### STX-848

8" WOOFER WITH 1" ASV VOICE COIL

- 150 Watts
- With Foam Edge
- Voice Coil: 1" ASV
- Magnet: 20 Oz.
- Frequency Response: 50Hz-12KHz
- Impedance: 8Ω
- Sensitivity: 88 dB
- Sold Individually

150 Watts



### STX-1048

10" WOOFER WITH 1.5" ASV VOICE COIL

- 300 Watts
- With Foam Edge
- Voice Coil: 1.5" ASV
- Magnet: 30 Oz.
- Frequency Response: 35Hz-10KHz
- Impedance: 8Ω
- Sensitivity: 88 dB
- Sold Individually

300 Watts



### STX-1248

12" WOOFER WITH 2" ASV VOICE COIL

- 350 Watts
- With Foam Edge
- Voice Coil: 2" ASV
- Magnet: 30 Oz.
- Frequency Response: 30Hz-10KHz
- Impedance: 8Ω
- Sensitivity: 89 dB
- Sold Individually

350 Watts



### STX-1548

15" WOOFER WITH 2" ASV VOICE COIL

- 600 Watts
- With Foam Edge
- Voice Coil: 2" ASV
- Magnet: 40 Oz.
- Frequency Response: 30Hz-8KHz
- Impedance: 8Ω
- Sensitivity: 89 dB
- Sold Individually

600 Watts







## LOUDSPEAKERS

### SRZ-616C

#### 6" DUAL CONE LOUDSPEAKER

- Frequency Response: 75-25000 Hz
- Magnet Weight: 16 Oz.
- Sensitivity: 88 dB
- Voice Coil Size: 1" ASV
- Max Power: 100 W
- Impedance: 8 Ohms
- Sold Individually

100 Watts



### SRZ-820C

#### 8" DUAL CONE LOUDSPEAKER

- Frequency Response: 55-25000 Hz
- Magnet Weight: 20 Oz.
- Sensitivity: 88 dB
- Voice Coil Size: 1" ASV
- Max Power: 150 W
- Impedance: 8 Ohms
- Sold Individually

150 Watts



### SRZ-1024C

#### 10" DUAL CONE LOUDSPEAKER

- Frequency Response: 35-15000 Hz
- Magnet Weight: 24 Oz.
- Sensitivity: 88 dB
- Voice Coil Size: 1.5" ASV
- Max Power: 300 W
- Impedance: 8 Ohms
- Sold Individually

300 Watts





## REPLACEMENT ACCESSORIES

- GK-8** (for 8") - Set of 4
- GK-10** (for 10") - Set of 4
- GK-12** (for 12") - Set of 6
- GK-15** (for 15") - Set of 8
- GK-18** (for 18") - Set of 8
- GK-69P** (for 69") - 1 Piece Gasket

### GASKET

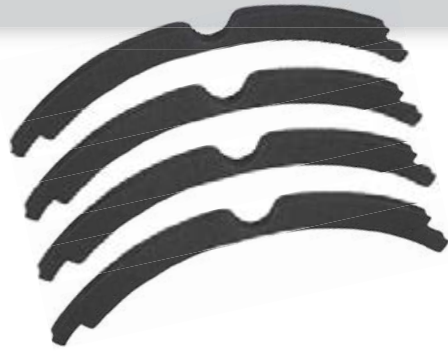

- NCE-10** (for 10")
- NCE-12** (for 12")
- NCE-15** (for 15")

### CLOTH EDGE

- Speaker Foam Repair



- NFE-4** (for 4")
- NFE-4.5** (for 4.5")
- NFE-5** (for 4")
- NFE-6** (for 6")
- NFE-196-7** (196mm for 8")
- NFE-228-186** (228mm for 6x9")
- NFE-243-8** (243mm for 10")
- NFE-298-9** (298mm for 12")
- NFE-368-9** (368mm for 15")
- NFE-18-GREY** (for 18")

### FOAM EDGE

- Inner Diameter: 13.5" / Outer Diameter: 17.5"





## REPLACEMENT ACCESORIES

**NPC-4** (for 4")

**NPC-5** (for 5")

**NCE-15** (for 15")

**PAPER CONE WITH FOAM EDGE**

- 196mm
- 1-1/2" Center Core



**NDC-72** (2.8" for 8")

**NDC-90** (3.50" for 10")

**NDC-114** (1-1/4")

**NDC-116** (4.56" for 12")

**NDC-124** (4.88")

**NDC-140** (5.51")

**NDC-150** (5.90")

**NDC-212** (2-1/2" Black)

**NDC-336** (3-3/16" Black)

**NDC-400** (4" Black)

**NDC-400S** (4" Silver)

**NDC-700** (7" Black)

**DUST CAP**



**NPC-196**

**PAPER CONE W/ FOAM EDGE FOR 8"**

- 196mm
- 1" Center Core



**NPC-243**

**PAPER CONE W/ FOAM**

- 243mm
- 1" Center Core





## REPLACEMENT ACCESSORIES

### NPC-228

PAPER CONE W/ FOAM EDGE

- 228mm
- For 6" x 9"
- 1" Center Core



### NPC-298

RIBBED PAPER CONE WITH FOAM EDGE

- 298mm
- For 12"



### NPC-368

RIBBED PAPER CONE WITH FOAM EDGE

- 368mm
- For 15"



### NPPC-R-ST-FM250 (10")

### NPPC-R-ST-FM300 (12")

NON PRESS PAPER CONE

- Machine Stitched Surround





## REPLACEMENT ACCESORIES

**NPC-4** (for 4")

**NPC-5** (for 5")

**NCE-15** (for 15")

PAPER CONE WITH FOAM EDGE

- 196mm
- 1-1/2" Center Core



**NFER-6.5-166** (for 6.5")

**NFER-8-196** (for 8")

**NFER-10-246** (for 10")

**NFER-12-294** (for 12")

**NFER-18-450** (for 18")

**NFER-15-371** (for 15")

RED FOAM EDGE



6.5"

**NFER-6.5-166**



8"

**NFER-8-196**



10"

**NFER-10-246**



12"

**NFER-12-294**



15"

**NFER-15-371**



18"

**NFER-18-450**

**NPC-8CE** (8")

**NPC-12CE** (12")

**NPC-6CE** (6")

**NPC-10CE** (10")

**NPC-18CE** (18")

PAPER CONE W/ CLOTH EDGE

- Center Core: 1.5" (38.1mm)
- Center Core: 1" (25.4mm)





## REPLACEMENT ACCESSORIES

### NPC-380CE

PAPER CONE W/ CLOTH EDGE

- Diameter: 15" (381mm)
- Center Core: 1.5" (38.1mm)



### NPD-10CE

DEEP NON-PRESS PAPER CONES CLOTH EDGE

- Diameter: 10" (254mm)
- Center Core: 1.5" (38.1mm)



### NPD-12CE (12")

### NPD-15CE (15")

### NPD-18CE (18")

DEEP NON-PRESS PAPER CONES CLOTH EDGE

- Center Core: 1.5" (38.1mm)



### NPD-18CE-SH (18")

SMOOTH CONE W/ CLOTH EDGE

- Diameter: 18" (457.2mm)
- Center Core: 3" (76.2mm)





## REPLACEMENT ACCESORIES

### NSP-73F

- Diameter: 7" x 3" x Flat

### NSP-110

- Diameter: 4.5" x 1" x Flat

### NSP-148

- Diameter: 6" x 1.5" x Flat

### NSP-168

- Diameter: 6.5" x 1-3/4" x Flat

### NSP-180

- Diameter: 7" x 2" x Flat

### NSP-214

- Diameter: 2 1/2" x 1" x Flat

### NSP-313

- Diameter: 3 3/4" x 1" x 1/2" x 3/8"

### NSP-414

- Diameter: 4 3/8" x 2" x 1/4"

### NSP-418

- Diameter: 5" x 1" x 2" x 1/4"

### NSP-524

- Diameter: 4" x 1" x 2" x 1/4"

### NSP-618

- Diameter: 6" x 1 3/4" x 3/8"

### NSP-623

- Diameter: 6" x 2" x 3/8"

### NSP-624

- Diameter: 6 1/2" x 2" x 1/4"

### NSPSQ-196 (196mm)

- Spider
- for 10" Square Woofer

### NSPSQ-200 (200mm)

- Spider
- for 10" Square Woofer

### NTX-405

- Piezo tweeter element
- for NTX-105045 & NTX-1504



### NTX-205

#### PIEZO TWEETER ELEMENT

- With Cone for NTX-1004PZ





## REPLACEMENT ACCESSORIES

**YD-200-210-C6M2 (8")**

**YD-250-211-C6M1 (10")**

**UNIVERSAL CLOTH EDGE**

- 12.3mm Core
- Adjustable Center Core



**YD-250-211-M1 (10")**

**UNIVERSAL FOAM EDGE**

- 13.3mm Core
- Adjustable Center Core



**YD-300-205-M2 (12")**

**YD-380-98-M2 (15")**

**UNIVERSAL FOAM EDGE**

- 26.6mm Core
- Adjustable Center Core



**YD-300-205-C6M2 (12")**

**YD-380-98-C6M2 (15")**

**UNIVERSAL CLOTH EDGE**

- 26.6mm Core
- Adjustable Center Core



**NPC-6CE (6")**

**NPC-8CE (8")**

**NPC-12CE (12")**

**NPC-18CE (18")**

**PAPER CONE WITH CLOTH EDGE**

- Center Core: 1" (25.4mm)







## CEILING SPEAKERS

### CS-606

#### CEILING SPEAKER

- 6"
- 80 Watt
- Plastic Cover
- With Transformer

80 Watts



### CS-607

#### 2 WAY CEILING SPEAKER

- 6" Woofer IMPP Cone with Rubber Edge
- 10 Oz. Magnet
- 1" ASV Coil
- 30mm
- Silk Tweeter



### CS-806

#### 8" PAPER CONE

- 1" Voice Coil
- 10 Oz. Magnet
- 8 Ohms Impedance
- 10 Watts Power Handling

10 Watts



### GRILL

#### CEILING SPEAKER GRILLS

- 8" Plastic



GT-4.5 (4.5")

GT-6.5 (6.5")

GT-8 (8")

GT-10 (10")

GT-12 (12")

GT-15 (15")

#### GRILL FOR TUBES





## CEILING SPEAKERS

### CS-65115-710V

#### 6 1/2" CEILING SPEAKER

- With 70V/100V Transformer can be Adjusted to 5W/10W/15W
- Load Rating @ 70V/100V: 15W
- Transformer Tappings @ 70V/100V: 15W-10W-5W
- Frequency Range: 50~20KHz
- SPL (@1Watt/1Meter): 90dB
- Impedance: 8 Ohms
- Dimension: Ø9.4"(238mm)
- Install Depth: 3.4"(86mm)
- Material: ABS
- Color: White



**Adjustable Wattage 5 W / 10 W / 15 W**

### CS-85115-710V

#### 8" CEILING SPEAKER

- With 70V/100V Transformer can be Adjusted to 5W/10W/15W
- Load Rating @ 70V/100V: 15W
- Transformer Tappings @ 70V/100V: 15W-10W-5W
- Frequency Range: 40~20KHz
- SPL (@1Watt/1Meter): 92dB
- Impedance: 8 Ohms
- Dimension: Ø10.9"(276mm)
- Install Depth: 3.7"(93mm)
- Material: ABS
- Color: White



**Adjustable Wattage 5 W / 10 W / 15 W**

### C SCT-6540

#### 6.5" CEILING SPEAKER

- Power Rating: 30W
- Frequency Range: 70-20KHz
- SPL (@1W/m): 88dB
- Speaker Diameter: 6.5"
- Impedance: 8 Ohms
- Dimension: Ø244mm

**30 Watts**



### CSTM-6510

#### 6.5" CEILING SPEAKER

- Power Rating: 10W
- Transformer Tapping's at 100V: 10W-5W
- Frequency Range: 130-15KHz
- SPL (@1W/m): 92dB
- Speaker Diameter: 6.5"
- Impedance: 8 Ohms
- Dimension: Ø185mm

**10 Watts**





## ACCESORIES / P.A. AMPLIFIERS

### WVC-HM50-48

#### 2 CHANNEL IN WALL VOLUME CONTROL

- Power Rating: 60 Watts per Channel
- Attenuation: 42dB Maximum per Channel
  - 1st Position (Fully Counterclockwise): Full-Off
  - 2nd Position and 3rd Position: Attenuate  $3 \pm 1$ dB per Step
  - 4th to 9th Position: Attenuate  $3 \pm 1$ dB per Step
  - 10th Position: Full On
- Insulation Resistance: 100M $\Omega$  Minimum @ 500V DC
- Dielectric Withstanding Voltage: 500V AC, 1 Min
- Frequency Response: 20Hz ~ 20KHz
- With 10 Volume Positions
- Weight: 7.8 Oz. (220g)



60 Watts



Rear View

### WVC-PA30-710V

#### IN WALL VOLUME CONTROL

- Power Handling: 25W (RMS) per Channel
- Attenuation: 50W Maximum per Channel
  - 1st Position (Fully Counterclockwise): Full-Off
  - 2nd Position and 3rd Position: Attenuate  $6 \pm 1$ dB per Step
  - 4th to 9th Position: Attenuate  $3 \pm 1$ dB per Step
  - 10th Position: Full On
- Insulation Resistance: 100M $\Omega$  Minimum @ 500V DC
- Dielectric Withstanding Voltage: 500V AC, 1 Min
- Weight: 7.8 Oz.



60 Watts



Rear View

### CA-2070BTUS

#### P.A. AMPLIFIER

MP3, USB, SD, BT, FM Player Included.

#### Inputs:

- MP3 Player x 1, USB Port x 1, SD Port x 1
- 3 Microphones: - 54dB 600 $\Omega$
- 1 AUX/MP3 IN: -18dB 20k
- Bass:  $\pm 10$ dB @ 100Hz
- Treble:  $\pm 10$ dB @ 10KHz
- 1 Master VOL -MIC 1-3 Volume Control MP3/AUX  
Volume Control Master Control

#### Output:

- Power: 180 Watts Peak, 90 Watts RMS  
Less Than 1% THD @ 1KHz
- Speaker Impedance: 4~8~16 $\Omega$  25V 70V 100V
- Frequency Response: 50~15,000Hz $\leq\leq\leq$ 3dB
- THD: 50~15,000Hz $\leq\leq\leq$ 1%
- SIN Ratio: >75dB
- Power Supply: AC 110V/60Hz, DC 24V



180 Watts





## P.A. AMPLIFIERS

### CA-500USBT

#### P.A. AMPLIFIER

- Power: 30 Watts Peak, 15 Watts RMS  
Less Than 1% THD @ 1KHz
- Speaker Impedance: 4~16Ω ≤ 3dB
- Frequency Response: 60 ~ 16,000Hz
- THD: 60 ~ 16,000Hz ≤ 1%
- SIN Ratio: >85dB
- Power Supply: AC 110/220V 60/50Hz, DC 12V

30 Watts



### CA-2070BTUS

#### P.A. AMPLIFIER

MP3, USB, SD, BT, FM Player Included.

#### Inputs:

- MP3 Player x 1, USB Port x 1, SD Port x 1
- 3 Microphones: - 54dB 600Ω
- 1 AUX/MP3 IN: -18dB 20k
- Bass: ± 10dB @ 100Hz
- Treble: ± 10dB @ 10KHz
- 1 Master VOL -MIC 1-3 Volume Control MP3/AUX  
Volume Control Master Control

#### Output:

- Power: 180 Watts Peak, 90 Watts RMS  
Less Than 1% THD @ 1KHz
- Speaker Impedance: 4~8~16Ω 25V 70V 100V
- Frequency Response: 50~15,000Hz≤≤≤3dB
- THD: 50~15,000Hz≤≤≤1%
- SIN Ratio: >75dB
- Power Supply: AC 110V/60Hz, DC 24V



Wireless  
Music Stream

180 Watts



### IS-AMP-220

#### HIFI STEREO AUDIO AMPLIFIER

- Input: DC 12V, 5A
- Power: 20W max, 10W RMS
- Speaker Impedance: 4~16Ω
- Frequency: 20Hz~20KHz

20 Watts





# P.A. AMPLIFIERS

## PA-6-2600UBT

6 ZONE PA AMPLIFIER WITH USB AND BT

- With Built-In USB / Bluetooth / Tuner/ TF Card
- With 3 MIC Inputs, 2 AUX Inputs and 1 Line Output
- 100V, 70V and 4-160hms Transformer Isolated Speaker Outputs
- Independent Gain Control for Each Zone
- Separate BASS and TREBLE Control
- Power Requirement: 110-220V AC, 50/60 Hz
- Power and Level Indicators
- Gain Control and Power Switch



260 Watts



Memory Stick



Rated Power Output	260W
Amplification	Analog 100V Transformer Type
Output	100V, 70V and 4-16 Ohms
Frequency Response	60 - 15KHz, +/- 3dB
THD	Less than 0.5% at 1KHz (1/3 Rated Power)
S/N Ratio	Better than 85dB
VOL Range	BASS: 100Hz (± 10dB), TREBLE: 12kHz (± 10 dB)
Controls	Gain controls and power switch
Cooling	Internal 12VDC fan

Indicators	Power and Level Indicators		
Power Consumption	180W	340W	465W
Dimensions	89(H) x 483(W) x 369(D) mm		
Built-in Dimensions	2 U rack 19 inch		
Carton Dimensions	185(H) x 520(W) x 435(D) mm		
Net Weight	12 kg	13.5 kg	15 kg
Gross Weight	13.8kg	15.2 kg	17 kg
Finish	Panel: aluminium, black Case: steel plate, black		

## NDVA-1000

DIGITAL MP3 PLAYER WITH FM RADIO

SUPPORTS USB, SD, FM & Remote Control

- Compatible with Format MP3 in Memory Type USB or SD
- USB/SD Memory Card Input
- FM Radio Frequency
- Remote Control



## IS-AMP-221BT

HIGH POWER AMPLIFIER

- USB, SD card input, FM Stereo radio
- MP3 audio format play
- External audio input
- GH-Power BTL output
- DC 12V input
- FM frequency range: 87.5MHz-108.0MHz
- Frequency response: 20Hz-20kHz
- Output power: RMS 20W+20W 1KHz
- Harmonic distortion: <0.05% 4W 1KHz
- SNR: 85dB
- High control: 12dB ± 10KHz
- Bass control: 12dB ± 100Hz
- The signal level: 220MV 47K

80 Watts





## MEGAPHONES

**ER-471-RB**

REPLACEMENT BATTERY



**ER-771-RB**

REPLACEMENT BATTERY



**ER-991-RB**

REPLACEMENT BATTERY



**ER-M191BT**

RECHARGEABLE MEGAPHONE

- Output: 30 Watts
- Rechargeable battery included
- Horn Diameter: 5" (127mm)
- Material: ABS Plastic



**30 Watts**

**SK-33S**

POWER MEGAPHONE

- Output: 30 Watts
- Power Source: Uses 6 x D Batteries
- Horn Diameter: 8" (205mm)
- Material: ABS Plastic



**30 Watts**



**ER-471BT**

MEGAPHONE WITH USB

- 35 Watts Megaphone
- Emergency siren
- Built in Recorder
- Supports Wireless Music Stream
- Megaphone with emergency siren
- Records and continuously repeat your voice
- With removable microphone
- Volume Control
- 6D size batteries
- Rechargeable Lithium battery



**35 Watts**  
**800 Meters**  
**Max Reach**





## P.A. HORN SPEAKER

### ER-1091BT

#### MEGAPHONE W/ WIRELESS MUSIC STREAM

- Dry Cell or Rechargeable Battery Operation
- All ABS Body, Sturdy Yet Light Weight
- Built-in Siren and Music
- 120 seconds Voice Recording Function
- Support U-disk
- Support Playing MP3, WAV
- Support Wireless Music Stream
- Power Output: 25W Rated / 50W Max
- Voice Range: 0.7-1 km
- Power Source: 8 x "D" Cells
- Battery Life: 8-10 Hrs
- Working Voltage: DC-12V
- Dimensions: Horn Dia.230mm, Length 350mm
- Weight: 1.21kg without Cells



50 Watts



### ER-991BT

#### MEGAPHONE WITH USB,MMC AND MP3 PLAYER

- Recording time up to 200 seconds
- Recordable function (records and continuously repeats)
- Megaphone with emergency siren
- 8 type C batteries not included
- Reaches a maximum of 1,640 yards
- 12V input
- 50 watts max
- Weights: 3.00 Lbs.
- Dimensions: Ø 9" x 13¾" (Diameter x Length)

#### Features:

- External microphone
- Recorder
- Emergency siren
- 110-220V rechargeable lithium battery (4th generation)
- Supports wireless music stream
- Carrying strap

50 Watts  
1,640 Yards  
Max Reach



### HS-405115-710V

#### HORN SPEAKER

- 12.4"x8.2"x14.5"
- With 70V/100V Transformer can be Adjusted to 5W/10W/15W
- Load Rating: 15W
- Impedance: 8 Ohms
- Protection Type: IP 66

Adjustable Wattage  
5 W / 10 W / 15 W





# MEGAPHONES

**H-16D**

ROUND TRUMPET HORN



**H-158D**

TRUMPET HORN SPEAKER

- 15" x 8"



**NAH-16** (16", Ivory Marfil)

**NAH-20** (20", Ivory Marfil)

ROUND TRUMPET HORN IVORY

- Without Driver



**NAH-158** (Ivory Marfil)

15" X 8" TRUMPET HORN

- Rectangle
- Without Driver



**TC-25**

8" - 4.5" HORN

- Frequency Range: 250Hz-8KHz
- RMS/Max Power: 40/80W
- Impedance: 8 Ohms



**80 Watts**

**TC-35S**

12V DC SIREN HORN

- Power Rating: 35W
- Current Drain: 1.3A
- Material: ABS Plastic



**35 Watts**

**TC-45**

ABS PLASTIC POWER HORN

- Power Handling: 50W RMS
- Frequency Response: 200Hz-8KHz
- Impedance: 8 Ohms



**50 Watts**

**TC-55**

POWERHORN

- Frequency Response: 350Hz-9KHz
- RMS/Max Power: 50/100W
- Impedance (Nominal): 8 Ohms



**100 Watts**





## P.A. HORN SPEAKER

### TC-305

#### 12" HORN SPEAKER

- Material: Aluminum
- Bracket: Steel
- Power: 40W (RMS)
- Impedance: 8 Ohms
- Frequency Response: 300-7000 Hz
- Dimension: 309(D)x286(L) mm [12"x11"]

40 Watts

#### 6" HORN SPEAKER ROUND, WITH DRIVER

- Max Power: 50 Watts
- Impedance: 8Ω
- Frequency Range: 400~7000Hz
- Sensitivity: 110dB

50 Watts



### NAH-08D

#### 8" HORN SPEAKER

- 8" Round, 5.2 Oz. Driver
- Max Power: 60 Watts
- Impedance: 8Ω
- Frequency Range: 400~7000Hz
- Sensitivity: 110dB

60 Watts



### TC-1108T

#### P.A HORN SPEAKER

- Horn Material: ABS
- Throat: Aluminum
- Bracket: Steel
- Diaphragm: Phenolic
- IP Rating: 65
- Power: 30W RMS, 60W Max
- Impedance: 8Ω
- Frequency Range: 300~8000Hz
- SPL@1W/1M: 110dB
- Voice Coil: 38 KSV
- Magnet: 3.1" x 1.6" x 0.6" (80 x 40 x 15mm)
- Dimension: 11.4"(W) x 8.4"(H) x 11.5"(L) (290 x 213 x 293mm)
- Weight: 4.4Lbs (2Kg)

60 Watts



### TC-1712T

#### P.A HORN SPEAKER

- Horn Material: ABS
- Throat: Aluminum
- Bracket: Steel
- IP Rating: 65
- Power: 50W RMS, 100W Max
- Impedance: 16Ω
- Frequency Response: 200~10000Hz
- SPL@1W/M: 112dB
- Diaphragm: Phenolic
- Voice Coil: 51.6 KSV
- Magnet: 4.3"x2.4x0.8" (110x60x20mm)
- Dimension: 15.9"x10.3"x13" (404 x 262 x 329mm)
- Weight: 7.9lbs (3.58KG)

100 Watts





## P.A. HORN SPEAKER / RECEIVER

### TC-604-30

#### P.A. HORN SPEAKER

- Dimensions: 6" x 4"
- RMS Power: 15W
- Max Power: 30W
- Impedance: 8 Ohm
- Frequency range: 250~7000Hz
- Sensitivity: 105dB

30 Watts



### AV-1006

#### 4" 6 TONE SIREN

- Operation Power: 12V, 35W
- Sensitivity: 119dB± 3db
- Impedance: 8 Ohms
- Maximum Power: 35 Watts

35 Watts



### SI-55S

#### PA SIREN

- Frequency Range: 300-5000Hz
- Sensitivity: 115-122dB
- 80 Watts
- 8 Ohms

80 Watts



### SI-77S

#### ELECTRONIC SIREN

- 100 Watts
- 8 Ohms
- 12V DC ± 10%

100 Watts



### CA-50WS

#### SECURITY PA AMPLIFIER

- Power: 100 Watts
- Frequency Range of Microphone: 420Hz - 1780Hz
- 12V, 7.5A
- With Microphone & 6 Sounds

100 Watts





# AMPLIFIER / UHF TRANSCEIVER

## CA-77WS

### SECURITY PA AMPLIFIER

- Power: 100 Watts
- Impedance: 8 Ohms
- 12V
- With Microphone & 6 Siren Sounds

**100 Watts**



## WLTK-100

### UHF TRANSCEIVER

- With High illumination Flashlight
- Scrambler
- Noise Reduction Circuit
- Long Standby Time
- Long Communication Range
- High Capability Li-ion Battery
- Battery Save, CTCSS, DCS
- Frequency Range: 400~470MHz
- RF Rated Power: ≤ 5W
- Channel Capacity: 16
- Operated Voltage: 3.7 V
- Dimensions: 4.5" x 2.4" x 1.3"
- Weight: 150g (0.3 Lbs)

#### SUPPLIED ACCESSORIES



**5 Watts**

## WLTK-052

### WALKIE-TALKIE SET

- Up to 3 Km Range
- 38 Selectable Tones for CTCSS Use
- 22 Channels
- Built-In LED Flashlight
- 10 Call Tones
- Backlit Display
- Talk Confirmation Tone
- Monitor
- Auto Squelch
- Keypad Tones
- Keypad Lock
- Battery Save
- Audible Low Battery Alert
- VOX Hands-Free Communication without the need for an Audio Accessory



**Up to 3 Km Range**



# UHF TRANSCEIVER / AIR TUBES

## AVAILABLE ACCESSORIES SOLD SEPARATELY



WLTK-100ANT - ANTENNA



WLTK-100CBL - CABLE/DISK



WLTK-100BAT - BATTERY



WLTK-100HF - HEADPHONES

## CS-44-40 WHT

### COLUMN SPEAKER

- Input Power: Rated 20W, Max 40W
- Output Power: 5, 10, 20, 40W
- Speaker: 7pcs Wide Band Speaker Measuring 70mm in Diameter (Paper Cone Speaker)
- Input Voltage: 70, 100V
- Impedance: 100V: 2K-1K-500-250Ω
- Frequency Response: 250-2000Hz (-10dB)
- Sound Pressure Level: 94dB (1W/M)
- Bracket: Steel
- Material: Aluminum
- Dimension: 3.9" x 3" x 24.4" (100x75x619mm)

40 Watts



## HA-12

### ECONOMIC TYPE

- 2-1/8" Wide
- 1" Deep
- Economy



## HA-15A / HA-15B

### AIR TUBE

- 2" Wide
- 2.5" Deep

## HA-15D

### AIR PORT TUBE

- 4" Wide
- 4.5" Deep

## HA-15C

### AIR PORT TUBE

- 3" Wide
- 4.5" Deep

## HA-15E

### AIR PORT TUBE

- 6" Wide
- 6" Deep





## AIR TUBES / NICKEL AIR TUBES

### HA-15BMP

#### BLACK RUBBER CABINET FOOT

- 1.5" diameter
- 3/4" height
- 3/8" hole diameter
- Material: Rubber
- Color: Black



This heavy-duty rubber foot offers a sure grip on all types of surfaces. Ideal for large rack cabinets or speaker cabinets.

### HA-24

#### AIR TUBE

- Heavy Duty Cabinet Lock
- 3-1/2" x 3-1/2"



### HA-35

#### DEEP AIR TUBE

- 2-3/4" Wide
- 4-3/4" Deep



### HA-5275

#### AIR PORT TUBE WITH GRILL

- 2.75" Wide
- 5" Deep



### HA-54

#### AIR TUBE

- 3" Wide
- 3" Deep
- Nickel





## SPEAKER WIRE / FANS

### CA00-16-500DBUV

OUTDOOR UV DIRECT BURIAL SPEAKER WIRE

- 16 Gauge
- 500 FT.
- Outdoor Burial



### CA00-16-502DBUV

OUTDOOR UV DIRECT BURIAL SPEAKER WIRE

- 16 Gauge
- 500 FT.
- Outdoor Burial



THE WHITE JACKET IS THE HARD PLASTIC WHICH ALLOWS THIS CABLE TO BE BURIED AND PROTECTED



THE WHITE JACKET IS THE HARD PLASTIC WHICH ALLOWS THIS CABLE TO BE BURIED AND PROTECTED

### 12-0715

DC FAN MOTOR

- 1 1/2" x 1 1/2" x 3/4"
- 12V



12 V

### 12-1030

DC FAN BRUSHLESS

- 3" x 3" x 1"
- 12V



12 V

### 12-1545

LUGGER FAN

- 4 6/8" x 4 6/8" x 1.5"
- 12V 0.30A
- 50/60Hz 0.14A
- Impedance Protected



12 V

### 12-2323

PLASTIC FAN

- 2 3/8" x 2 3/8" x 8 7/8"
- 12V
- 60mm x 60mm x 225mm



12 V



## FANS

### 24-3131

#### LUDGER FAN

- 7/8" x 3 1/8" x 3 1/8"
- 24V 0.11A
- Impedance Protected



24 V

### FAN-33

#### EXTREMELY EFFICIENT

- 2 3/8" x 2 3/8" x 1"
- 28 Cubic Feet per Minute
- 12V 0.8A



12 V

### FAN-55

#### EXTREMELY EFFICIENT

- 4 6/8" x 4 6/8" x 1.5"
- 106 Cubic Feet per Minute
- 12V 1.0A



12 V

### FAN-550HS

#### EXTREMELY EFFICIENT

- 4 7/8" x 4 7/8" x 1.5"
- Current: 2A, Power: 24W
- Speed: 4350RPM
- 12V
- Speed Control



12 V

### 110-1032

#### DC FAN BRUSHLESS

- 1" x 1" x 3/8"
- 110V



### 110-1545

#### MINI FAN

- 4 1/2" x 4 1/2" x 1 1/2"
- 110V



### 110-15475

#### MINI FAN

- 4.72" x 4.72" x 1.49"
- 110V



### FAN-4712LERG

#### COOLING FAN WITH LED

- Product Size: 120 x 120 x 25 mm (4.7" x 4.7" x 1")
- Rated Voltage: 12V (for fan)
- Rated Current: 1A
- Airflow: 36CFM
- Fan Speed: 2000 (±10% RPM)
- Sound Level: 21-34 dB
- Bearing Type: Hydraulic Bearing
- Lifetime: 30000Hrs
- Dual ring LED circle (12 LED lights automatically change)



12 V

Highly optimized low-noise design with outstanding static pressure and airflow (CFM), ideal for chassis ventilation.



**MESH GRILLS / FOAMS**

**GLKT-6.5**

- 2 GR-8, 8 NP-1 & 8 NSC-001

**GLKT-8**

- 2 GR-8, 8 NP-1 & 8 NSC-001

**GLKT-10**

- 2 GR-10, 8 NP-1 & 8 NSC-001NSP-618

**GLKT-12**

- 2 GR-12, 8 NP-1 & 8 NSC-001

**GLKT-15**

- 2 GR-15, 8 NP-1 & 8 NSC-001

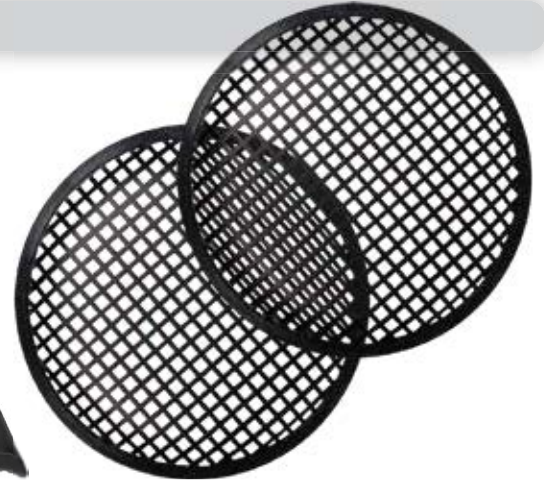

**SPEAKER GRILL**

**GP-8 (8")**

**GP-10 (10")**

**GP-12 (12")**

**SPEAKER GRILL**

- Plastic Grill
- Perfect Grill Marine or Humid Enviroments



**GP-5 (5")**

**GP-6 (6")**

**GP-6.5 (6.5")**

**GP-8 (8")**

**GP-10 (10")**

**GP-12 (12")**

**GP-15 (15")**

**GP-18 (18")**

**SPEAKER GRILL**

- Plastic Grill
- Perfect Grill Marine or Humid Enviroments







# GRILLS

## NC-1

GRILL CLIPS WITH SCREWS



GT-4.5 (4.5")

GT-6.5 (6.5")

GT-8 (8")

GT-10 (10")

GT-12 (12")

GT-15 (15")



### SPEAKER GRILL

- 2 Piece Metal Grill
- Prefect for Custom Type Installations

FGR-3131 (3-1/8" x 3-1/8")

FGR-3737 (3.7" x 3.7")

FGR-4747 (4.7" x 4.7")

### FAN GRILL

- Metal

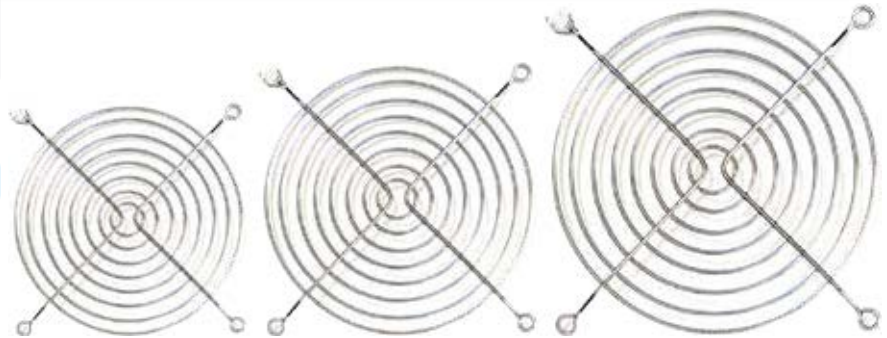



## MESH GRILLS / FOAMS

### GR-24 BLK

#### FULL MESH GRILL

- 2' x 4' x 1.2mm
- Black Finish

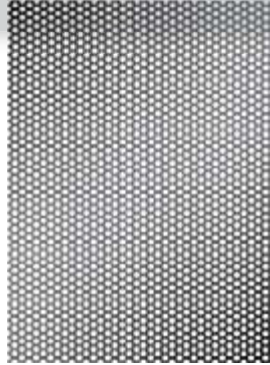

### GR-24NC

#### FULL MESH GRILL

- 2' x 4' x 1.2mm
- Nickel Finish

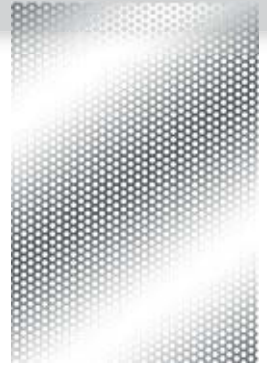

### GR-24HCB

#### FULL MESH GRILL

- 2' x 4' x 1.2mm
- Black Finish
- Honeycomb Mesh

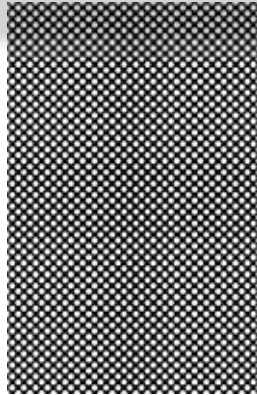

### GR-35 BLK

#### FULL MESH GRILL

- 3' x 5' x 1.2mm
- Black Finish



### GR-44 BLK

#### FULL MESH GRILL

- 4' x 4' 1.2mm
- Black Finish

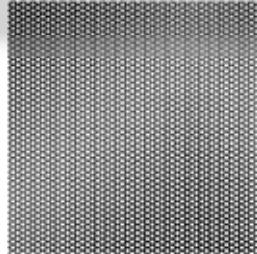

### GR-24FOAM

#### ACOUSTIC GRILL FOAM

- 2' x 4'
- Thickness: 0.40"



### GR-2400SP

#### SPEAKER CABINET STEEL MESH GRILL

- 2' x 4' x 1.2mm
- Lined with a Black Foam Insulation



### GR-3500SP

#### SPEAKER CABINET STEEL MESH GRILL

- 3' x 5' x 1.2mm
- Lined with a Black Foam Insulation





# CABINET CORNER PROTECTORS

**HA-30**

**CABINET CORNER PROTECTOR**

- 2"
- Enclosure
- Black Finish



**HA-32**

**CABINET CORNER PROTECTOR**

- 3" x 2"
- Black Finish



**HA-40 BLK (1" x 1")**

**HA-45 BLK (2" x 1.5")**

**THREE LEG METAL CABINET CORNER PROTECTOR**

- 2" x 1.5"
- Black Metal Finish



**HA-47A (Right)**

**HA-47B (Left)**

**METAL CABINET CORNER**

- Black Finish
- Metal High Quality Cabinet, Corner Protectors Adds, Style and Durability to any Project.



**HA-48 BLK**

**HA-48 NKL**

**METAL CABINET CORNER**

- 1.5" x 1.5"
- Black or Nickel Finish

HA-48 NKL



HA-48 BLK



**HA-50**

**CABINET CORNER**

- 3"
- Enclosure
- Black Finish



**HA-51**

**CABINET CORNER**

- 2" x 2"
- Only 2 Screw Holes for Faster & More Economical Installation
- Black Finish



**HA-53**

**PLASTIC CABINET CORNER**

- 5" x 3"
- Black Finish





# CABINET CORNER PROTECTORS / CABINET HANDLES

## HA-212 NKL

### METAL CABINET CORNER

- Weight: 30g
- .40mm Thick
- 90°
- Nickel Finish



## HA-214 BLK

### METAL CABINET CORNER

- Weight: 50g
- .50mm Thick
- 90°
- Black or Nickel Finish



## HA-215 NKL

### METAL CABINET CORNER

- Weight: 70g
- .65mm Thick
- 90°
- Nickel Finish



## HA-215-INL

### METAL CABINET CORNER

- Weight: 40g
- 1.0mm Thick
- 90°
- Nickel Finish



## HA-10

### POCKET ENCLOSURE

- 5.5" x 3.5"



## HA-100 BLK (Black Color)

## HA-100 NKL (Nickel Color)

### SPRING SURFACE

- 5.5" x 3.5"



## HA-1062

### ABS RECESSED ROUND HANDLE

- 10" (H) x 6" (W) x 2.5" (D)



## HA-20

### CARRYING BELT

- 10" x 1"





## CABINET HANDLES

**HA-200 BLK** (Black Color)

**HA-205 NKL** (Nickel Color)

**RECESSED FLIP HANDLE  
BLACK**

- 6.25" x 4.25"
- Spring Surfaces



**HA-300**

**METAL CABINET HANDLES**

- 9" x 7"



**HA-350**

**LARGE RECESSED HANDLE**

- 9" x 7"
- Plastic



**HB-40 BLK**

**PLASTIC HANDLE**

- 5" x 2.5"



**HA-400**

**LARGE RECESSED METAL  
HANDLE**

- 10.75" x 6.5"



**HA-550**

**METAL HANDLE**

- 6.25" x 6.5 x 5.5"



**HA-762**

**ABS RECESSED ROUND HANDLE**

- 7.5" (H) x 6" (W) x 2.5" (D)





## CABINET LOCKS

**HA-15**

**RUBBER CABINET FOOT**

- ???



**HA-25**

**LARGE RUBBER CABINET FOOT**

- Metal Washer
- 2.5"



**HB-10 BLK**

**HB-10 CHR (CHROMD)**

**PADLOCKING DRAWBOLT**

- Draw Bolt



**HB-20BLK**

**LIFT OFF HINGE**

- ??



**HB-44**

**HEAVY DUTY CABINET LOCK**

- Heavy Duty Cabinet Lock
- 3-1/2" x 3-1/2"



**HB-55BLK**

**CABINET HEAVY DUTY LOCK**

- Heavy Duty Cabinet Lock
- 4-1/8" x 4"



**HL-544BLK**

**HEAVY DUTY LOCK**

- 6-3/4" x 5"
- Black



**NP-1**

**GRILL CLIP**

- ??





# CABINET LOCKS

**NP-3**

**DJ CABINET CLIP**

- ??



**SC-03**

**SPEAKER CLAMP**

- ??



**HR-600**

**SCREW TYPE LONG WHEEL**

- Screw Type
- Long Wheel Caster



**HS-35**

**6.5' DJ CABINET BRACKET**

- ??

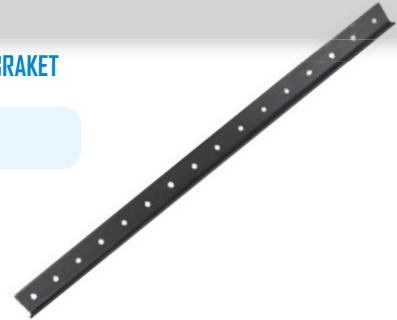

**HA-400**

**LARGE RECESSED METAL HANDLE**

- 10.75" x 6.5"



**HA-550**

**METAL HANDLE**

- 6.25" x 6.5 x 5.5"



**HA-762**

**ABS RECESSED ROUND HANDLE**

- 7.5" (H) x 6" (W) x 2.5" (D)





## SPEAKER TERMINALS

### 2I-243

#### SPEAKER TERMINAL CONNECTOR

- Size: 4 to 5mm
- Type: Plug-In Connector



### T-110

#### SPEAKER TERMINAL

- Size: 2 1/8"
- Type: Push-In



### X-450RTF

#### DOUBLE SPEAKER TERMINAL

- Double Speakon w/ Double 1/4" Terminal and Foam Seal
- In/Out XLR Terminal
- In/Out 1/4" Terminal
- Banana Plug/Speaker Wire Input



### T-200

#### SPEAKER TERMINAL (COLOR CODED)

- Size: 3 3/4" x 3"
- Type: Screw-In



### T-235G

#### SPEAKER TERMINAL (GOLD)

- Size: 3 3/4" x 3"
- Type: Screw-In



### TE-30

#### SPEAKER TERMINAL

- Size: 2 1/8"
- Type: Screw-In



### TE-40

#### SPEAKER TERMINAL

- Size: 2 1/4" x 2 1/4"
- Type: Screw-In



### TE-50

#### SPEAKER TERMINAL

- Size: 2 1/2" x 3"
- Type: Screw-In







# SPEAKER TERMINALS

**NB-506 (2P)**

**NB-507 (4P)**

**SPRING TENSION**

- Color Coded



**X-825**

**DOUBLE SPEAKER TERMINAL**

- 2 1/4" Sockets
- 7" x 5"
- Without Crossover



**X-870**

**DOUBLE SPEAKER TERMINAL**

- 2 1/4" Sockets
- 7" x 5"
- With Crossover



**XT-200**

**DOUBLE SPEAKER**



**XT-2214**

**DOUBLE SPEAKER**

- Double 1/4" Terminal



**XK-862-1**

**TERMINAL BOARD**

- Length: 136 mm
- Width: 89 mm
- Weight: 95 g



**TE-22G**

**SPEAKER TERMINAL**

- 2" x 2"
- Push-In Type with Gold Post



**TE-24G**

**SPEAKER TERMINAL**

- 2" x 2"
- Screw-In Type with Gold Post





## SPEAKER TERMINALS

### T-300J

#### TERMINAL

- 2 1/4" Jacks



### T-500

#### T-500J (Two 1/4" Jacks)

#### TERMINAL WITH GOLDEN-PLATING

- 4"
- Gold Ends
- Two 1/4 Jacks



### T-700G

#### TERMINAL

- 3 1/8" x 3 1/8"
- Gold Post



### T-705PG

#### TERMINAL

- 3.25" x 3.25" x 1"
- Gold Post



## TERMINAL BINDING POST- GOLD

## TERMINAL PUSH-IN BINDING POST- GOLD

### TCR-200

#### SPEAKER TERMINAL

- Size: 3-1/4" x 4"
- Type: 2 1/4" Jacks without Crossover



### TCR-200SQ

#### SPEAKER TERMINAL

- Size: 3-1/4" x 4"
- Type: 2 1/4" Jacks with Crossover



### TCR-300R

#### SPEAKER TERMINAL

- Size: 3"
- Type: 3-Way with Crossover

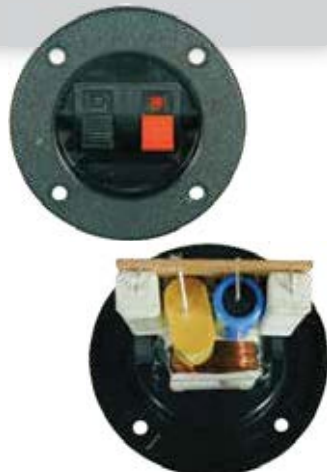

### N-D103TV

#### 10 PIN DIN PLUG TO RCA 4 WAY PLUG

- Connection type features: 3-Male to 10-Pin RCA Composite Audio-Video Cable
- Perfect audio video cable that eliminates unwanted noise/feedback for pure, clear audio-video; minimal signal loss for reliably consistent video
- Cable Length: 5 feet (1.3 meters); Red-White-Yellow color-marked connectors for quick, easy audio/video hookups





# SPEAKER TERMINALS / SPEAKER CROSSOVER

**P-101TRA**

**1/4" RIGHT ANGLE PLUG**

- For Speaker Cables (12 Gauge & Up) Microphone Cable (All)



**NB-117B (Black)**

**NB-117R (Red)**

**BANANA PLUG**

- Dual Mini Plug



**NB-417 BLK (Black)**

**NB-417 RED (Red)**

**BANANA PLUG**

- Dual



**ZP-RCA-PG**

**GOLD-PLATED RCA PLUG**

- Set of Two



**801**

**3-WAY CROSSOVER**

- Frequency Response: 2.5K-5KHz
- Power RMS/Max: 75/150W
- Impedance: 8 Ohms

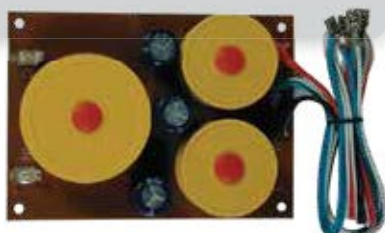

**1001**

**3-WAY CROSSOVER**

- Frequency Response: 2.5K-5KHz
- Power RMS/Max: 100/200W
- Impedance: 8 Ohms

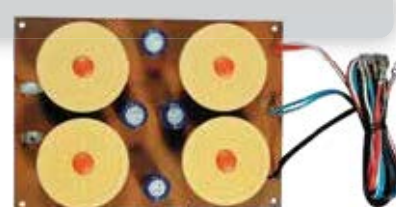

**1201**

**3-WAY CROSSOVER**

- Frequency Response: 2.5K-5KHz
- Power RMS/Max: 125/250W
- Impedance: 8 Ohms

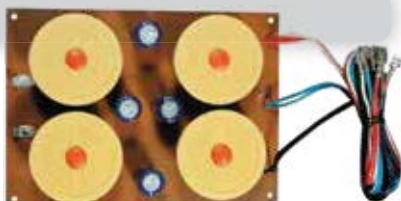

**1501**

**3-WAY CROSSOVER**

- Frequency Response: 2.5K-5KHz
- Power RMS/Max: 175/350W
- Impedance: 8 Ohms



**HC-101**

**1 CHANNEL  
SUBWOOFER CROSSOVER**

- Frequency Response: 120Hz Low Pass
- Power RMS/Max: 200/400W
- Impedance: 4 Ohms



**T-37 BLK**

**T-37 RED**

**TERMINAL BINDING POST**

- Terminal Binding Post



**NB-416 BLK**

**BANANA PLUG**

- Long handle



**NB-416 RED**

**BANANA PLUG**

- Long handle





## SPEAKER CROSSOVER VOICE COIL

- KVA-60** (2-3/8", 58.48mm)
- KVA-90** (2-6/8", 66.04mm)
- KVA-100** (3-1/8", 78.74mm)
- KVA-100D** (3-1/8", 78.74mm)
- KVA-800** (3-2/8", 81.28mm)

### KAPTON VOICE COIL

- Voice Coil Kapton 2.5"



- KVC-1** (1", 25.4mm)
- KVC-1.5** (1.5", 38.1mm)
- KEVC-1.5** (1.5", 38.1mm)
- KVC-2** (2", 50.8mm)
- KVC-2.5** (2.5", 63.5mm)
- KVC-3** (3", 76.2mm)
- KVC-4** (4", 101.6mm)

### KAPTON VOICE COIL

- Voice Coil 1.5" 2 Layer



- NVC-26** (1", 25.4mm)
- NVC-38** (1.5", 38.1mm)
- NVC-44** (2", 50.8mm)
- NVC-51** (2.5", 63.5mm)
- NVC-5104** (2", 51mm)
- NVC-63** (3", 76.2mm)
- NVC-77** (4", 101.6mm)
- NVC-100** (4", 101.6mm)

### KAPTON VOICE COIL

- Voice Coil 26mm 1"



## BW-TXX24-50

### SPEAKERS CABLE

- 49.2 FT (15 Meters)
- 24 Gauge





## VOICE COIL

### NSDV-4000USA

REPLACEMENT VOICE COIL

- For NTX-4000USA



### NSDV-3000

REPLACEMENT VOICE COIL

- For NTX-3000



### NSDV-3500

REPLACEMENT VOICE COIL

- For NDX-3520, NDX-3540 & NDX-3580



### NSDV-4040K

REPLACEMENT VOICE COIL

- 4" Voice Coil

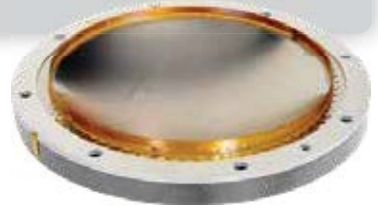

### NSDV-417

REPLACEMENT VOICE COIL

- For NTX-417



### NSDV-420

REPLACEMENT VOICE COIL

- For NTX-420 & NTX-410



### NSDV-6720

REPLACEMENT VOICE COIL

- For NDX-6720



### NSDV-6740

REPLACEMENT VOICE COIL

- For NDX-6740



### NSDV-1312

REPLACEMENT VOICE COIL

- 1.35" KSV Voice Coil
- Impedance: 8Ω



### NSDV-2222PL

REPLACEMENT VOICE COIL

- 2" Voice Coil





*2022 CATALOG*



## LOW MID FREQUENCY SPEAKERS

### AOCT-850

#### 8" LOW MID FREQUENCY SPEAKER

- 500 Watts Power (P.M.P.O.)
- 250 Watts Power (R.M.S.)
- Frequency Response: 70-10,000Hz
- Sensitivity: 93dB
- 2" TIL Voice Coil
- Die-Cast Aluminum Basket
- Mounting Depth: 88mm (3 1/2")
- Impedance: 8 Ohms
- 50 Oz Magnet



8"

### AOCT-HF8

#### LOW MID FREQUENCY SPEAKER

- 700 Watts Power (P.M.P.O.)
- 350 Watts Power (R.M.S.)
- Frequency Response: 70-10,000Hz
- 3" KSV Voice Coil
- Powder Black Paint Aluminum Basket
- Sensitivity: 92dB
- Impedance: 8 Ohms
- Mounting Depth: 90mm (3 9/16)
- 60 Oz Magnet



8"

700 Watts Max Power

8Ω

### AOCT-HF8-D4

#### LOW MID FREQUENCY SPEAKER

- 800 Watts Power (P.M.P.O.)
- 400 Watts Power (R.M.S.)
- Frequency Response: 65 - 8,000Hz
- 3" KSV Voice Coil
- Powder Black Paint Aluminum Basket
- Sensitivity: 92dB
- Impedance: 2 x 4 Ohms
- Mounting Depth: 90mm (3 9/16)
- 60 Oz Magnet



8"

800 Watts Max Power

DUAL  
4Ω

**LOW MID FREQUENCY SPEAKERS**

**ADCT-1250**

**LOW MID FREQUENCY SPEAKER**

- 1000 Watts Power (P.M.P.D.)
- 500 Watts Power (R.M.S.)
- Frequency Response: 40 - 4,000 Hz
- Sensitivity: 95dB
- 3" TIL Voice Coil
- Die-Cast Aluminum Basket
- Mounting Depth: 5"
- Impedance: 8 Ohms
- 600 Oz Magnet



**ADCT-1050**

**LOW MID FREQUENCY SPEAKER**

- 800 Watts Power (P.M.P.D.)
- 400 Watts Power (R.M.S.)
- Frequency Response: 50 - 5,000 Hz
- Sensitivity: 95dB
- 2.5" TIL Voice Coil
- Die-Cast Aluminum Basket
- Mounting Depth: 4 - 7/16"
- Impedance: 8 Ohms
- 50 Oz Magnet



**APLM-10**

**LOW MID FREQUENCY LOUSPEAKER**

- 1000 Watts Power (P.M.P.D.)
- 500 Watts Power (R.M.S.)
- Frequency Response: 60 ~ 7,000Hz
- Sensitivity: 95dB
- 3" TIL Voice Coil
- Die-Cast Aluminum Basket
- Mounting Depth: 108 mm (4-1/4")
- Impedance: 8 Ohms
- 75 Oz Magnet





**NWA-830CE**

**8" PROFESSIONAL PUBLIC ADDRESS WOOFER**

- 200 Watts Power (P.M.P.O.)
- 100 Watts Power (R.M.S.)
- Frequency Response: 50-9000Hz
- Sensitivity: 90dB
- 1.5" 2-layer Voice Coil Kapton
- Rigid Steel Basket
- Mounting Depth: 84mm(3.31")
- Impedance: 8 Ohms
- 30 Oz. Magnet

8"



**NWA-1063**

**10" PROFESSIONAL PUBLIC ADDRESS WOOFER**

- 800 Watts Power (P.M.P.O.)
- 400 Watts Power (R.M.S.)
- Frequency Response: 35-4000Hz
- Sensitivity: 92dB
- 3" 2-Layer Voice Coil Kapton
- Rigid Steel Basket
- Mounting Depth: 104mm(4.1")
- Impedance: 8 Ohms
- 50 Oz. Magnet

10"



3" voice Coil

**NWA-1263**

**12" PROFESSIONAL PUBLIC ADDRESS WOOFER**

- Power Handling: 700W RMS/1400W Max
- Frequency Response: 30 - 3500Hz
- Sensitivity: 94dB
- Impedance: 8 Ohms
- Magnet: 90 Oz.
- 3" 2-Layer Kapton Voice Coil
- Vented Magnet Structure

12"



3" voice Coil

**NWA-1283**

**12" PROFESSIONAL PUBLIC ADDRESS WOOFER**

- 1000 Watts Power (P.M.P.O.)
- 500 Watts Power (R.M.S.)
- Frequency Response: 40-5000Hz
- Sensitivity: 94dB
- 3" 2-Layer Voice Coil BASV
- Rigid Steel Basket
- Mounting Depth: 131mm (5.16")
- Impedance: 8 Ohms
- 75 Oz. Magnet

**INCREASE  
POWER  
HANDLING**

12"



3" voice Coil

**PROFESSIONAL WOOFERS**

**NWA-1563**

**15" POWER WOOFER**

- Power handling: 600W RMS/1200W max
- Frequency response: 30-3500Hz
- Sensitivity: 94dB
- Impedance: 8 ohms
- Magnet: 60 oz.
- 3" 2-layer Kapton voice coil
- Vented magnet structure

15"



**3" voice Coil**

**NWA-1593**

**15" POWER WOOFER**

- Power handling: 700W RMS/1400W max
- Frequency response: 30-3500Hz
- Sensitivity: 94dB
- Impedance: 8 ohms
- Magnet: 90 oz.
- 3" 2-layer Kapton voice coil
- Vented magnet structure

15"



**3" voice Coil**

**APLB-10**

**10" DYNAMIC LOUDSPEAKER**

- |                                    |                                  |
|------------------------------------|----------------------------------|
| ▪ 600 Watts Power (PMPD)           | ▪ Rigid Steel Basket             |
| ▪ 300 Watts Power (RMS)            | ▪ Mounting Depth: 111 mm (4.37") |
| ▪ Frequency Response: 40 - 4,000Hz | ▪ Impedance: 8 W                 |
| ▪ Sensitivity: 96 dB               | ▪ 80 Oz. Magnet                  |
| ▪ 3" Til Voice Coil                |                                  |

10"



**APLB-12**

**12" DYNAMIC LOUDSPEAKER**

- |                                    |                                  |
|------------------------------------|----------------------------------|
| ▪ 600 Watts Power (PMPD)           | ▪ Rigid Steel Basket             |
| ▪ 300 Watts Power (RMS)            | ▪ Mounting Depth: 111 mm (4.37") |
| ▪ Frequency Response: 40 - 4,000Hz | ▪ Impedance: 8 W                 |
| ▪ Sensitivity: 96 dB               | ▪ 80 Oz. Magnet                  |
| ▪ 3" Til Voice Coil                |                                  |

12"



**PROFESSIONAL WOOFERS**

**NWA-15204**

**15" POWER WOOFER**

- Power handling: 700W RMS/1400W max
- Frequency response: 35-4500Hz
- Sensitivity: 95dB
- Impedance: 8 ohms
- Magnet: 200 oz.
- 4" 2-layer Kapton voice coil
- Vented magnet structure

15"



4" voice Coil

**NWA-15204D**

**15" POWER WOOFER**

- Power handling: 700W RMS/1400W max
- Frequency response: 28-2500Hz
- Sensitivity: 98.3dB
- Impedance: 8 ohms
- Magnet: 100 oz.
- 3" 2-layer Kapton voice coil
- Rigid steel basket
- Die cast

15"



3" voice Coil

**NWA-18204**

**18" POWER WOOFER**

- Power handling: 800W RMS/1600W max
- Frequency response: 28-3200Hz
- Sensitivity: 95dB
- Impedance: 8 ohms
- Magnet: 200 oz.
- 4" 2-layer Kapton voice coil
- Vented magnet structure

18"



4" voice Coil

**PROFESSIONAL WOOFERS**

**NWA-18204D**

**18" PRECISION PROFESSIONAL WOOFER**

- 4" 2-Layer Voice Coil BASV
- Die-cast Aluminum Basket
- Vented Magnet Structure
- 200 Oz. Magnet
- Sensitivity: 95 dB
- 1800 Watts Programmed Power
- Frequency Response: 28 - 3200Hz
- Mounting Depth: 195mm (7.68")
- Impedance: 8Ω

18"



**NWA-2100-ND**

**21" PRECISION PROFESSIONAL WOOFER**

- 2400 Watts Power (P.M.P.O.)
- 1200 Watts Power (R.M.S.)
- Frequency Response: 30 - 2,000Hz
- Sensitivity: 95dB
- 6" 2-Layer Voice Coil BASV
- Die-cast Aluminum Basket
- Mounting Depth: 222mm (8.74")
- Impedance: 1 Ohm
- 145x8mm Neodymium Magnet Structure

21"



**NEODYMIUM  
 magnet  
 Speaker Series**

**ODP-653 WHT**

**2-WAY WEATHER-PROOF PROFESSIONAL  
MONITOR SPEAKER**

- 6.5" 2-Way
- 6.5" Monitor Speaker
- Max Power: 100 Watts
- Sensitivity: 90 dB
- Impedance: 8 Ohms
- Frequency Response: 55-20KHz
- 3 Year UV Resistant Housing
- Anti-corrosive, Water Resistant Alluminum Grill
- LED Flashes to the music
- Gross Weight: 7.05 lbs.
- Dimension: 8.3" x 7.3" x 12.2"



**ODP-653 BLK**

**2-WAY WEATHER-PROOF PROFESSIONAL  
MONITOR SPEAKER**

- 6.5" 2-Way
- 6.5" Monitor Speaker
- Max Power: 100 Watts
- Sensitivity: 90 dB
- Impedance: 8 Ohms
- Frequency Response: 55-20KHz
- 3 Year UV Resistant Housing
- Anti-corrosive, Water Resistant Alluminum Grill
- LED Flashes to the music
- Gross Weight: 7.05 lbs.
- Dimension: 8.3" x 7.3" x 12.2"



**ODP-650DBT**

**6.5" MONITOR SPEAKER**

- Maximum Power: 100Watts
- Sensitivity: 90dB
- Impedance: 4 Ohms
- Frequency Response: 55-20KHz
- 3 Year UV Resistant Housing
- Anti-corrosive Aluminum Grill, Water-Resistant
- Gross Weight: 7.9 KG/PAIR
- Dimension: 8.1" x 8.5" x 13.4" (205x215x340mm)
- Audio Power: AC 100-240V



**OUTDOOR**



*Amplified*

**INDOOR/OUTDOOR  
 WATER-RESISTANT SPEAKERS**

**ODP-800WH**

**8" SPEAKER**

- Maximum Power: 160W
- Frequency Response: 60 - 020kHz
- Impedance: 8 Ohms
- Sensitivity: 92dB
- 3 year UV Resistant Housing
- Anti-Corrosive Aluminum Grill, Water-Resistant
- Flashes LED to the Music
- Safety Belt
- Available in Black and White
- Gross Weight: 5.3KG
- Dimension: 245 x 235 x 360mm  
 (9.5" x 9.3" x 14.2")



**OUTDOOR**

**ODC-830BK**

**ODC-830WH**

**8" SPEAKER**

- Maximum Power: 240W
- Frequency Response: 45 - 20kHz
- Impedance: 8 Ohms
- Sensitivity: 90dB
- 3 Year UV Resistant Housing
- Anti-Corrosive Aluminum Grill, Water-Resistant
- Flashes LED to the Music
- Safety Belt
- Available in Black and White
- Gross Weight: 6.9KG
- Dimension: 290 x 255 x 425mm  
 (11.4" x 10" x 16.7")



**OUTDOOR**

**APH-552580-H**

**5" HIGH FREQUENCY  
 ALUMINUM DIE CASTING HORN**

- High frequency Horn
- Aluminum Exponential Horn
- Bolt-on Fitting
- Exit Throat size: 2"
- Overall Dimensions:  
 5"(H) x 5"(W) x 3"(D)
- Mounting depth: 2.5"



**APH-625080-H**

**6" HIGH FREQUENCY  
 ALUMINUM HORN**

- High Frequency Horn
- Aluminum Exponential Horn
- Bolt-on Fitting
- Exit Throat Size: 2"
- Overall Dimensions:  
 6.2"(H) x 6.2"(W) x 5.1"(D)
- Mounting depth: 4.9"



**APH-6556**

**HIGH FREQUENCY HORN**

- High Frequency Horn Plastic Horn
- Throat Size: 1.375"
- Overall Dimensions: 5.6" (H) x 5.6" (W) x 7.2" (D)
- Mounting Depth: 6.5"



**Metal Socket for Solid Fitting**

**APH-775080-H**

**8" HIGH FREQUENCY ALUMINUM HORN**

- High Frequency Horn
- Aluminum Exponential Horn
- Bolt-on Fitting
- Exit Throat Size: 2"
- Overall Dimensions: 7.7"(H) x 7.7"(W) x 4.9"(D)
- Mounting depth: 4.6"



**APH-1061080-H**

**HIGH FREQUENCY HORN**

- High Frequency Horn
- ABS Horn
- Bolt-on Fitting
- Exit Throat Size: 2"
- Overall Dimensions: 10.4"(H) x 6"(W) x 10.7"(D)
- Mounting depth: 10"



**10" x 6"**

**2" Exit Throat**

**APA-3500BT**

**AUDIO / VIDEO AMPLIFIER RECEIVER**

- Aluminum Front Panel, Audio/Video Amplifier
- With AM/FM Radio, Auto Search and Preset 100 Channels
- Wireless Bluetooth Function
- HDMI 2 Input / 1 Output
- USB/SD, Digital VFD Display
- Memory Function
- MIC 1 / MIC 2 Input
- Dual Voltage: 115V / 240V



**DVD  
INPUT**

**HDMI  
2 IN / 1 OUT**

**USB/SD  
Playback**

**Memory  
Function**

**MIC 1  
MIC 2**

**AM/FM  
Radio**

**Bass/  
Treble**

**AUX  
INPUT**

**AQ-3000**

**PROFESSIONAL POWER AMPLIFIER**

- Out Power (8Ω): 2x300W
- Out Power (4Ω): 2x500W
- Out Power (2Ω): 2x800W
- Out Power (BRIDGE) (8Ω): 1000W
- Out Power (BRIDGE) (4Ω): 1300W
- Frequency response @ Half Pwr: 15Hz-25KHz (+0/-1dB)
- THD+Noise @ 1KHz Full Pwr: <0.03%
- IMD 60Hz & 7KHz, 4:1:<0.038%
- Signal to Noise Ratio: >102dB
- Slew Rate (input filter limited): 40V/μs
- Damping factor 1KHz @ 80hm: > 400:1
- Input sensitivity: Selectable (0.77V / 1.0V /1.44V)
- Input Impedance: 10K Ohm Balance to ground
- Input Connectors: Female XLR-3 & 6.35mm TRS Jack
- Output Circuit Type: Class AB
- Output Connectors: 4 Pole Speakon & Binding posts
- Protections: Full short-circuit, Open-circuit, Thermal, Soft-start, DC voltage, Sub/Ultrasonic and RF
- LED Indicators (per channel): Bridge, Parallel, Power, Signal, Clip, Protect
- Panel controls: Front-2 input attenuators Rear-Ground lift, mode selection, compressor
- Cooling: Front-to-Back via 2 variable-speed fans
- Power supply volatge: 110V AC/60Hz
- Power supply Fuse (250): 12A
- Dimensions: 19.0" x 17.3" x 5.2"
- Weight: 55.1 lbs



XLR INPUT
1/4" TRS INPUT
STEREO DUAL CHANNEL
SPEAKON OUTPUTS

**AQ-5000**

**PROFESSIONAL POWER AMPLIFIER**

- Out Power (8Ω): 2x600W
- Out Power (4Ω): 2x1050W
- Out Power (2Ω): 2x1400W
- Out Power (BRIDGE) (8Ω): 1750W
- Out Power (BRIDGE) (4Ω): 2300W
- Frequency response @ Half Pwr: 15Hz-25KHz (+0/-1dB)
- THD+Noise @ 1KHz Full Pwr: <0.03%
- IMD 60Hz & 7KHz, 4:1:<0.038%
- Signal to Noise Ratio: >102dB
- Slew Rate (input filter limited): 40V/μs
- Damping factor 1KHz @ 80hm: > 400:1
- Input sensitivity: Selectable (0.77V / 1.0V /1.44V)
- Input Impedance: 10K Ohm Balance to ground
- Input Connectors: Female XLR-3 & 6.35mm TRS Jack
- Output Circuit Type: Class AB
- Output Connectors: 4 Pole Speakon & Binding posts
- Protections: Full short-circuit, Open-circuit, Thermal, Soft-start, DC voltage, Sub/Ultrasonic and RF
- LED Indicators (per channel): Bridge, Parallel, Power, Signal, Clip, Protect
- Panel controls: Front-2 input attenuators Rear-Ground lift, mode selection, compressor
- Cooling: Front-to-Back via 2 variable-speed fans
- Power supply voltage: 110V AC/60Hz
- Power supply Fuse (250): 12A
- Dimensions: 19.0" x 17.3" x 5.2"
- Weight: 55.1 lbs



XLR INPUT
1/4" TRS INPUT
STEREO DUAL CHANNEL
SPEAKON OUTPUTS



**AQM-1400BT**

**MIC-LINE MIXER-USB AUDIO INTERFACE**

- Powered by USB from your computer or via USB power adapter (included).
- CH 1 and 2 microphone (balanced XLR) inputs or (unbalanced 1/4 inch) instruments; (impedance TS) inputs with switchable low noise +48V phantom power for microphones.
- Balanced 1/4-inch TRS inputs for stereo or mono line-level sources on CH 3.
- 1/4-inch TRS output jacks work with balanced or unbalanced lines.
- 1/8-inch TRS stereo AUX/MP3 input.
- Stereo output, independent from the PC interface switch
- Stereo 1/4-inch TRS headphone jack with independent level control for output monitoring.
- Independent controls for both sets of inputs, main output, and headphone monitor.
- Red LED signal/clip indicator for CH 1-2.
- No special drivers are needed with most modern version of Windows, Mac OS and Linux.
- USB cable, USB power adapter.
- High-quality wireless Bluetooth (version 5.0) features.
- Rugged steel chassis.



**AQM-1600BT**

**MIC-LINE MIXER-USB AUDIO INTERFACE**

- Powered by USB from your computer or via USB power adapter (included).
- CH 1 and 2 microphone (balanced XLR) inputs or (unbalanced 1/4 inch) instruments; (impedance TS) inputs with switchable low noise +48V phantom power for microphones.
- Balanced 1/4-inch TRS inputs for stereo or mono line-level sources on CH 3.
- 1/4-inch TRS output jacks work with balanced or unbalanced lines.
- 1/8-inch TRS stereo AUX/MP3 input.
- Stereo output, independent from the PC interface switch
- Stereo 1/4-inch TRS headphone jack with independent level control for output monitoring.
- Independent controls for both sets of inputs, main output, and headphone monitor.
- Red LED signal/clip indicator for CH 1-2.
- No special drivers are needed with most modern version of Windows, Mac OS and Linux.
- 1.5M DC Power Cable.
- High-quality wireless Bluetooth (version 5.0) features.
- Rugged steel chassis.



**ODP-423BK****INDOOR/OUTDOOR WEATHERPROOF  
LOUDSPEAKER**

- 4" 2-Way
- 4" Monitor Speaker
- Maximum Power: 60 Watts
- Sensitivity: 92dB
- Impedance: 8 Ohms
- Frequency Response: 70-20 KHz
- 3 Year UV Resistant Housing
- Anti-Corrosive Aluminum Grill, Water-Resistant
- LED Flashes to the Music
- Available in Black or White
- Gross Weight: 3.8 KG/Pair
- Dimension: 6.7" x 6" x 8.7"

**ODP-423WH****INDOOR/OUTDOOR WEATHERPROOF  
LOUDSPEAKER**

- 4" 2-Way
- 4" Monitor Speaker
- Maximum Power: 60 Watts
- Sensitivity: 92dB
- Impedance: 8 Ohms
- Frequency Response: 70-20 KHz
- 3 Year UV Resistant Housing
- Anti-Corrosive Aluminum Grill, Water-Resistant
- LED Flashes to the Music
- Available in Black or White
- Gross Weight: 3.8 KG/Pair
- Dimension: 6.7" x 6" x 8.7"



**CRX-1002K**

**CROSSOVER**

- Maximum Power: 400W
- Impedance: 8 Ohms
- Crossover Frequency: 2,000 Hz
- Slope Ratio: 12dB



**CRX-1004K**

**CROSSOVER**

- Maximum Power: 400W
- Impedance: 8 Ohms
- Crossover Frequency: 4,000 Hz
- Slope Ratio: 12dB



**CRX-1600**

**CROSSOVER**

- Maximum Power: 1000W
- Impedance: 8 Ohms
- Crossover Frequency: 600 Hz
- Slope Ratio: 12dB



**CRX-22K**

**CROSSOVER**

- Maximum Power: 600W
- Impedance: 4 or 8 Ohms
- Crossover Frequency: 2,000 Hz
- 2-Way



**CRX-23K**

**CROSSOVER**

- Maximum Power: 600W
- Impedance: 4 or 8 Ohms
- Crossover Frequency: 3,000 Hz
- 2-Way



**CRX-3003K**

**CROSSOVER**

- Maximum Power: 600W
- Impedance: 4 or 8 Ohms
- Crossover Frequency: 375 Hz/ 3,000 Hz
- 3-Way



**CRX-2003KHP**

**CROSSOVER**

- Maximum Power: 800W
- Impedance: 4 or 8 Ohms
- Crossover Frequency: 3,000 Hz
- 2-Way



**CRX-3005KHP**

**CROSSOVER**

- Maximum Power: 1000W
- Impedance: 4 or 8 Ohms
- Crossover Frequency: 625 Hz - 5,000 Hz
- 3-Way



**CROSSOVERS**

**CRX-125HP**

**CROSSOVER**

- Maximum Power: 1000 Watts
- Impedance: 4 or 8 Ohms
- Crossover Frequency: 125 Hz
- Bass Crossover

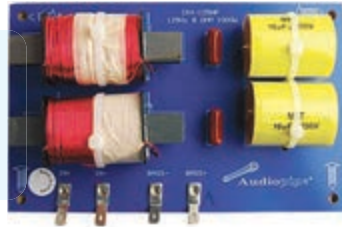

**CRX-2012K**

**CROSSOVER**

- Maximum Power: 650 Watts
- Impedance: 8 Ohms
- Crossover Frequency: 1.2KHz
- Crossover Frequency: 650Hz
- 2-Way



**CRX-2123KSHP**

**CROSSOVER**

- Maximum Power: 1200 Watts
- Impedance: 4 or 8 Ohms
- Crossover Frequency: 3KHz
- 2-Way



**CRX-D2005KHP**

**CROSSOVER**

- Maximum Power: 1000 Watts
- Impedance: 8 Ohms
- Crossover Frequency: 5000Hz
- 2-Way



**CRX-XT2003K**

**CROSSOVER**

- Maximum Power: 800 Watts
- Impedance: 8 Ohms
- Crossover Frequency: 3000Hz
- Input Connections: Speakon
- 2-Way



**CRX-203**

**CROSSOVER**

- 300 Watts
- 2-Way Passive Crossover Network



**CRX-FUSE**

**CROSSOVER**

- Fuse Lamps
- Output: 12V
- Power 25 Watts
- Dimension: Ø10 x 38mm
- Replaces Fuses for the Following Models: CRX-2003KHP & CRX-3005KHP



**CRX-FUSE-44**

**CROSSOVER**

- Fuse Lamps
- Output: 12V
- Power 25 Watts
- Dimension: Ø10 x 44mm



**XTR-2214GR**

**3 WAY CROSSOVER PANEL**

- 500 Watts

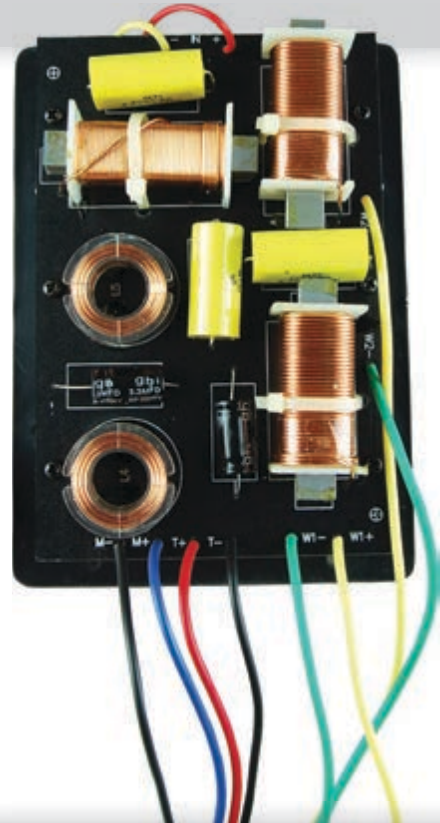
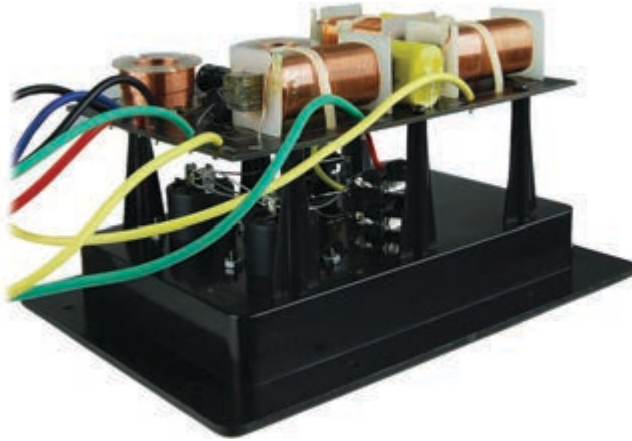

**XTR-D2005KHP**

**CROSSOVER KIT**

- Max Power: 1000 Watts
- Impedance: 8 Ohms
- Crossover Frequency: 5000 Hz
- Input Connections: Speakon
- Plastic Terminal Box
- Compatible with Most OEM Crossover
- Mounting Diameter: 4 3/8" x 5"

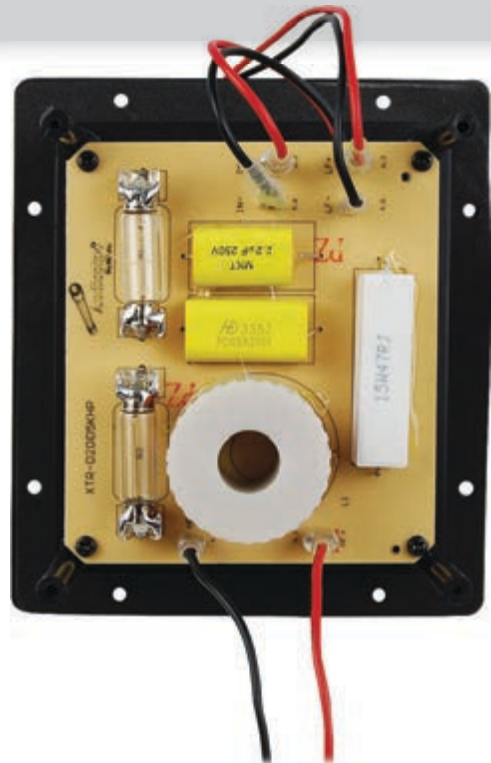

**COMPRESSION DRIVERS**

**APH-4545-CD**

**COMPRESSION DRIVER**

- 70 Watts Power (P.M.P.O.)
- 3.5" Titanium Driver
- Frequency Range: 1K-20KHz
- Sound Pressure: 110dB±2dB
- Voice Coil: 1.3" KSV
- Impedance: 8 Ohms
- Magnet: 12 Oz.



**APCD-44FR**

**COMPRESSION DRIVER**

- 80 Watts Power (P.M.P.O.)
- 1,500 - 20,000Hz
- 104dB
- Titanium Diaphragm
- 1.75" Kapton
- 113mm x 15mm Ferrite Magnet
- Magnet: 20 Oz.



**APCD-50FR**

**COMPRESSION DRIVER**

- 100 Watts Power (P.M.P.O.)
- 1,000 - 20,000Hz
- 105dB
- Titanium Diaphragm
- 2" Kapton
- 134mm x 17mm Ferrite Magnet
- Magnet: 34.4 Oz.



**APCD-78FR**

**COMPRESSION DRIVER**

- 400 Watts Power (P.M.P.O.)
- 1,000 - 20,000Hz
- 107dB
- Titanium Diaphragm
- 3" Kapton
- 156mm x 20mm Ferrite Magnet
- Magnet: 50 Oz.



**ADR-250**

**DRIVER**

- 150 Watts Power (P.M.P.O.)
- 75 Watts Power (R.M.S.)
- Frequency Response: 400-8000 Hz
- Sensitivity: 107dB
- Resin Film Diaphragm
- 2" Kapton Voice Coil with Round Aluminum Wire
- 105mm X 12mm Ferrite Magnet
- SOLD Individually



**APFD-320T-ND**

**DRIVER**

- 220 Watts Power (P.M.P.O.)
- 110 Watts Power (R.M.S.)
- Frequency Response: 500-18000 Hz
- Sensitivity: 108dB
- Titanium Diaphragm
- 3" Kapton Voice Coil with Flat Wire
- Neodymium Magnet
- SOLD Individually

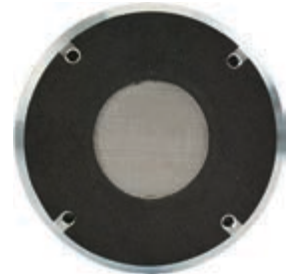

**ADR-250-VC**

- Replacement Kapton Voice Coil



**APFD-320T-ND-VC**

- Replacement Kapton Voice Coil



**APFD-360T**

**DRIVER**

- 220 Watts Power (P.M.P.O.)
- 110 Watts Power (R.M.S.)
- Frequency Response: 500-18000 Hz
- Sensitivity: 108dB
- Titanium Diaphragm
- 3" Kapton Voice Coil with Flat Wire
- 170mm X 20mm Ferrite Magnet
- SOLD Individually

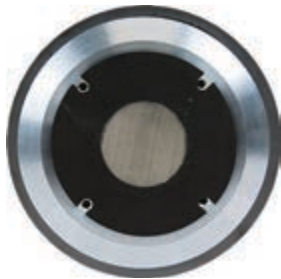

**APCD-4085**

**DRIVER**

- 1800 Watts Power (P.M.P.O.)
- 900 Watts Power (R.M.S.)
- Frequency Response: 300-7000 Hz
- Sensitivity: 110dB
- Resin Film Diaphragm
- 4" Kapton Voice Coil with Round Aluminum Wire
- 200mm X 20mm Ferrite Magnet
- SOLD Individually



**APFD-360T-VC**

- Replacement Kapton Voice Coil



**APCD-4085-VC**

- Replacement Kapton Voice Coil



**COMPRESSION DRIVERS**

**APH-4545-H**

**HIGH FREQUENCY HORN**

- Plastic Horn
- Throat Size: 1.375"
- Overall Dimensions: 2.3"(H) x 4.5"(W) x 5"(D)



**Metal Socket for Solid Fitting**



Shallow Mount  
**3 1/2"**

**Sold Individually**



**APH-4040**

**4.5" TITANIUM DRIVER**

- Size:  $\Phi 116$  x H57.5mm
- Max Power: 120 Watts
- R.M.S. Power: 60 Watts
- Impedance:  $8\Omega \pm 15\%$  (at 100Hz)
- Sound Pressure Level: 103dB  $\pm 2$ dB (at 1M 1W)
- Frequency Response: 1000-20KHz
- Total Weight: 1.74Kg
- Voice Coil: 1.75" KYV, DCR 6.4 $\Omega \pm 5\%$
- Magnet:  $\Phi 116$  x  $\Phi 45$  x  $\Phi 15$ mm (Y30)
- Plate & T yoke: 7/7mm
- Sold Individually



**APH-5050**

**TITANIUM COMPRESSION DRIVER**

- 160 Watts Power (P.M.P.O.)
- 80 Watts Power (R.M.S.)
- Frequency Response: 1800-20KHz
- Sensitivity: 108dB
- Impedance: 8 Ohms
- Titanium Diaphragm
- 2" Kapton Voice Coil
- 134mm x 17mm Ferrite Magnet
- 35 Oz. Magnet



**160Watts MAX**

**APH-5050-VC**

**REPLACEMENT KAPTON VOICE COIL**

- 2" Titanium Super Diaphragm
- 2" High Temperature Kapton Voice Coil
- One Diaphragm



**APCDAD-917**

**BOLT-ON DRIVER TO HORN ADAPTER**

- Overall Dimension : 5.9" Diameter x 4.35" Height
- Adapter 2" Side 4.35" Diameter : 4 Bolt Holes Slotted On 4" Circle
- Adapter 1.5" Side 4.35" Diameter : 4 Bolt Holes Slotted On 4" Circle
- Material: ABS Hard Plastic
- Net Weight: .114 lbs





**COMPRESSION DRIVERS**

**APFD-323PH-ND**

**RESIN FILM COMPRESSION DRIVER**

- 220 Watts Power (P.M.P.O.)
- 110 Watts Power (R.M.S.)
- Frequency Response: 500 - 18,000Hz
- Sensitivity: 108 dB
- Resin Film Diaphragm
- 3" Kapton Voice Coil with Flat Wire
- Neodymium Magnet



**APFD-540PH-ND**

**RESIN FILM COMPRESSION DRIVER**

- 400 Watts Power (P.M.P.O.)
- 200 Watts Power (R.M.S.)
- Frequency Response: 900~8,000Hz
- Sensitivity: 110 dB
- Resin Film Diaphragm
- 4" Kapton Voice Coil
- Neodymium Magnet



**APFD-323PH-ND-VC**

**REPLACEMENT KAPTON VOICE COIL**

- Resin diaphragm
- 3" Kapton Voice coil with flat aluminum wire
- One diaphragm



**Now with resin film diaphragm for improved high frequencies**

**APHL-8634**

**1.4" LINE ARRAY SYSTEM HORN**

- Material: Plastic Covered Steel
- Throat Diameter: 35.5mm (1.4")
- Mounting Diameter: 101mm & 75mm (4" & 3")



**COMPRESSION DRIVERS**

**APHC-4550**

**3.5" COMPRESSION DRIVER WITH ABS HORN COMBO**

- 70 Watts Power (P.M.P.D)
- 35 Watts Power (R.M.S)
- Frequency Response: 1K-20KHZ
- Sensitivity: 110dB ± 2Db
- Impedance: 8 Ohms
- Titanium Diaphragm
- 1.3" Kapton Voice Coil
- 90mm X 15mm Ferrite Magnet
- 12 Oz. Magnet
- High Frequency ABS Horn
- Throat Size: 1.375"
- Overall Dimensions: 4.5" X 4.5" X 5.1"
- Mounting Depth: 72mm (2-7/8")



**Metal Socket For Solid Fitting**



**APHC-4550-VC**

**REPLACEMENT KAPTON VOICE COIL**

- 2" Titanium Super Diaphragm
- 1.3" High Temperature Kapton Voice Coil
- Sold Individually



**Made for Models: APHC-4550**



**APHC-6256**

**PRO COMPRESSOR DRIVER KIT**

- 400 Watts Power (P.M.P.D)
- 200 Watts Power (R.M.S)
- Frequency Response: 1,000 - 20K HZ
- Sensitivity: 110dB ± 2dB
- Impedance: 8 OHMS
- Titanium Diaphragm
- 2" Kapton Voice Coil
- 134mm X 17mm Ferrite Magnet
- 33 Oz. Magnet
- High Frequency Aluminum Horn
- Exit Throat Size: 2"
- Overall Dimensions: 6.2"H x 6.2"W x 5.6"D
- Mounting Depth: 2-7/8"



**6.2"**



**400Watts**

**COMPRESSION DRIVERS**

**APHC-6278**

**PRO COMPRESSOR DRIVER KIT**

- 400 Watts Power (P.M.P.D)
- 200 Watts Power (R.M.S)
- Frequency Response: 1K - 20K HZ
- Sensitivity: 110dB
- Impedance: 8 Ohms
- Titanium Diaphragm
- 2" Kapton Voice Coil
- 134mm X 17mm Ferrite Magnet
- 33 Oz. Magnet
- High Frequency Aluminum Horn
- Exit Throat Size: 2"
- Overall Dimensions: 6.2" H X 6.2 W X 7.8" D
- Mounting Depth: 7.3"



**400Watts**

**APHC-6256-VC / 6278-VC**

**REPLACEMENT KAPTON VOICE COIL**

- Titanium Diaphragm
- 2" Kapton Voice with Flat Aluminum Wire
- Sold Individually



**Made for Models:  
APHC-6256 & APHC-6278**

**APCDAD-2550**

**HORN ADAPTER**

- Outer Diameter: Ø 126mm
- Height: 20mm
- Thread: 1 3/8"



**126 mm**

**APCDAD-775**

**HORN ADAPTER**

- Outer Diameter: Ø 150mm
- Height: 20mm
- Thread: 1 3/8"

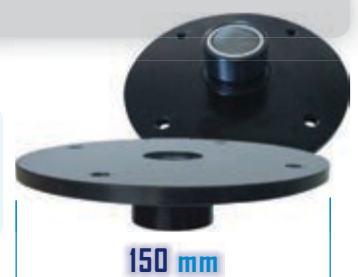

**150 mm**

**COMPRESSION DRIVERS /  
POWER MIXERS**

**APCDAD-44FR**

**REPLACEMENT**

- Replacement Voice Coil for APCD-44FR



**NSDV-4000USA**

**TITANIUM DIAPHRAGM**

- Impedance: 8 Ohms
- 500W MAX

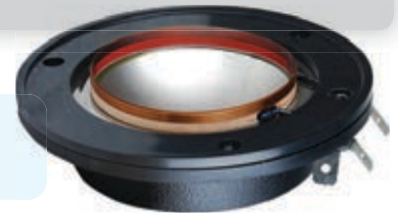

**APCDAD-50FR**

**REPLACEMENT**

- Replacement Voice Coil for APCD-50FR



**APCDAD-78FR**

**REPLACEMENT**

- Replacement Voice Coil for APCD-78FR



**APCDAD-900RC**

**REPLACEMENT**

- 3" Voice Coil Kits
- Replacement for: APCD-940FR / APCD-924ND / APCD-976FR



**ATV-4545**

**REPLACEMENT**

- 2" Titanium Super Diaphragm
- 1.3" High Temperature Kapton Voice Coil
- One Diaphragm
- Replacement for: APH-4545-CD



**AQP-AD6181-110**

**POWER SUPPLY**

- 110V/60Hz, 600mA, 20W
- Indoor Use Only
- Work to: AQP-6100DU / AQP-8100DU



**AQP-AD6181-220**

**POWER SUPPLY**

- 220V/50Hz, 600mA, 20W
- Indoor Use Only
- Work to: AQP-6100DU / AQP-8100DU



**AQP-6100DU**

**6 CHANNEL MIXING CONSOLE WITH TWO STEREO CHANNELS AND A SEPARATE STEREO TAPE CHANNEL**

- Separate Input Jack Controls for Mix and Line Input on all Mono Channels
- Low-Noise, Discrete Mic Preamplifiers on all Microphone Inputs
- Dedicated Inserts on all Mono Channels
- Balanced 1/4" Stereo Jacks and Balance Controls on all Stereo Channels
- Separate Stereo Tape Channel with 1/4" and RCA Jacks
- Stereo Output for Recording Applications
- Active 3-Band EQ on all Mono Channels
- 2-Band EQ on Stereo Channels
- AUX and Effects Paths as well as Separate Gain Controls on all Channels
- AUX Send Controls in the Main Section for Optimal Level Adjustment
- Headphone Output with Dedicated Volume Control
- Built-In +48V Phantom Power for Condenser Mics
- MP3 Input and Playback
- 99 DSP Digital Multi-Effects (Optional 16 DSP Effects)
- Weight: 6.6 lbs. (3 Kg)



**AQP-8100DU**

**8 CHANNEL MIXING CONSOLE WITH TWO STEREO CHANNELS AND A SEPARATE STEREO TAPE CHANNEL**

- Separate Input Jack Controls for Mix and Line Input on all Mono Channels
- Low-Noise, Discrete Mic Preamplifiers on all Microphone Inputs
- Dedicated Inserts on all Mono Channels
- Balanced 1/4" Stereo Jacks and Balance Controls on all Stereo Channel
- Separate Stereo Tape Channel with 1/4" and RCA Jacks
- Stereo Output for Recording Applications
- Active 3-Band EQ on all Mono Channels
- 2-Band EQ on Stereo Channels
- AUX and Effects Paths as well as Separate Gain Controls on all Channels
- AUX Send Controls in the Main Section for Optimal Level Adjustment
- Headphone Output with Dedicated Volume Control
- Built-In +48V Phantom Power for Condenser Mics
- MP3 Input and Playback
- 99 DSP Digital Multi-Effects (Optional 16 DSP Effects)
- Weight: 7.7 lbs. (3.5 Kg)



**AQM-1200XLR**

**2 CHANNEL GUITAR - SINGER - MIXING CONSOLE**

- Sensitivity / Impedance CH1, CH2 XLR: 2mV/1.8KΩ (Gain Max)  
CH1 Jack: 10mV/12KΩ (LINE) Line, Channel 2: 30mV/20KΩ (LINE);  
30mV/240KΩ(GUITAR) Output Level: 5.8V Max (MAIN; MONITOR)
- Frequency Range: 20Hz-22KHz
- THD: <math>\leq 0.05\%</math>
- S/N Ratio: 80dB (A Weighted)
- Equalizer: Bass Range:  $\pm 15\text{dB}/80\text{Hz}$ ; High Range:  $\pm 15\text{dB}/12\text{KHz}$
- Headphone Impedance:  $\geq 16\Omega$
- USB Interface: USB1.1 Compatible, 16-Bit Delta-Sigma, 44.1KHz  
Sampling Rates; 48KHz Max
- Phantom Power: +48V
- Power Supply: Via USB Port (5V/500mA) of the Computer or Via  
Power Supply Unit Provided and Connected to AC 100-240V 50/60Hz
- Dimensions: 100x45x135mm
- Weight: 430g
- Suitable Operating System for Data Transfer Via USB  
Interface: Windows 2000, XP or Higher; Mac OS 9.0.4  
or Higher, 10.X or Higher



**AQM-1300U**

**3 CHANNEL MIC-LINE MIXER-USB AUDIO INTERFACE**

- Sensitivity/ Impedance: Mic: 1mV/1.7KΩ (Gain max)  
Line, channel 1: 3mV/12KΩ (Gain max) Line, channel 2/3: 150 mV/22KΩ  
Tape in: 300mV/22KΩ
- Output level: 5.8V max (MAIN; MONITOR)
- Frequency range: 20 - 25000 Hz
- THD:  $\leq 0.05\%$
- S/N ratio: 81 dB (A weighted)
- Headphone impedance:  $\geq 16\Omega$
- Equalizer: Bass range:  $\pm 15\text{dB}/80\text{Hz}$ ; High range:  $\pm 15\text{dB}/12\text{kHz}$
- USB interface: USB1.1 compatible, 16-Bit Delta-Sigma, 44.1 kHz  
Sampling rates; 48kHz max.
- Phantom power for XLR jack: +18V
- Power supply: via USB port (5V/500mA) of the computer or via power  
supply unit provided and connected to AC100-240V 50/60Hz
- Dimensions: 101 x 40 x 135 mm (4.0" x 1.6" x 5.3")
- Weight: 430 g (0.95 Lbs)
- Suitable operating system for data transfer via USB interface:  
Windows 2000, XP or higher; Mac OS 9.0.4 or higher, 10.X or higher.



**3 Channel**



AC 110-240V



XLR Input



USB 5V DC

**AQM-1300BT**

**3 CHANNEL MIC-LINE MIXER-USB AUDIO INTERFACE**

- Sensitivity / Impedance Mic: 1mV/1.7KΩ (Gain Max)  
Line, Channel 1: 3mV/12KΩ (Gain Max) Line, Channel 2/3: 200mV/22KΩ  
Tape in: 300mV/22KΩ
- Output Level: 5.8V Max (MAIN; MONITOR; TAPE)
- Frequency Range: 20Hz-2500Hz
- THD: ≤0.05%
- S/N Ratio: 81dB (A Weighted)
- Equalizer: Bass Range: ±15dB/80Hz; High Range: ±15dB/12KHz
- Headphone Impedance: ≥16Ω
- USB Interface: USB1.1 Compatible, USB 2.0 Full Speed 16-Bit Delta-Sigma, 44.1kHz Sampling Rates; 48kHz Max
- Bluetooth: Compliant with Bluetooth Specification V3.0 + EDR
- Phantom Power for XLR Jack: +18V
- Suitable Operating System for Data Transfer Via USB Interface: Windows 2000, XP or Higher; Mac OS 9.0.4 or Higher, 10.X or Higher
- Power Supply: Via USB Port (5V/500mA) of the Computer or Via Power Supply Unit Provided and Connected to AC 100-240V 50/60Hz
- Dimensions: 100x45x135mm
- Weight: 430g



**DJAP-1034A**

**10" PROFESSIONAL ACTIVE LOUDSPEAKER**

- 300 Watts
- Wireless Music Stream
- 2-Way Configuration with Active Filter, Amplifier
- Wireless Remote Control
- 2.5" Titanium Driver
- 10" Woofer with 1.5" ASV Voice Coil
- Class A/B Amplifier, USB Host/SD MP3
- Impedance: 4 Ohms
- Frequency Range: 50Hz-20KHz
- 2-Way Mic Input (XLR/1/4" Jack), Line Input (RCA), Line Output RCA
- Maximum Power: 300W
- Power Source: 115V/230V
- Magnet: 33 Oz.
- Dimensions: 320x250x500mm 12.6" x 10" x 20"
- Weight: 8Kg (17.6 lbs)



**DJAP-1254A-CMB**

**PROFESSIONAL ACTIVE LOUDSPEAKER, MICROPHONE AND STAND COMBO**

- Wireless Music Stream
- 2-Way Configuration with Active Filter, Amplifier
- Wireless Remote Control
- 2.5" Titanium Driver
- 12" Woofer with 2" ASV Voice Coil
- Class A/B Amplifier, USB Host/SD MP3
- Impedance: 4 Ohms
- Frequency Range: 45Hz-20KHz
- 2-Way Mic Input (XLR/1/4" Jack), Line Input (RCA), Line Output RCA
- Maximum Power: 400W
- Power Source: 115V/230V
- Magnet: 40 Oz.
- Dimensions: 380x300x580mm  
15" x 11.8" x 22.8"
- Weight: 10Kg (22 lbs)



**DJAP-1575-BDMC**

**PROFESSIONAL ACTIVE LOUDSPEAKER**

- Includes Tripod, Wireless Microphone, and Wireless Remote Control
- Wireless Music Stream
- 2-Way Configuration with Active Filter, Amplifier
- Wireless Remote Control
- FM tuner
- Rechargeable Battery
- Dual Wireless Mic
- 2.5" Titanium Driver
- 15" Woofer with 2" ASV Voice Coil
- Class A/B Amplifier, Memory Stick Host
- Impedance: 8 Ohms
- Frequency Range: 45Hz-20KHz
- 2-Way Mic Input (XLR/1/4" Jack), Line Input (RCA), Line Output RCA
- Max. Power: 1000W
- Power Source: 115V/230V
- Magnet: 40 Oz
- Dimensions: 17.7" x 14" x 27"
- Weight: (41.9 lbs)



**LED LIGHTING**



**Amplified System  
1000W  
Max Power**



**DJAP-1562P-CMB**

**15" PROFESSIONAL PASSIVE LOUDSPEAKER WITH STAND**

- 2-Way Configuration with Active Filter, a Handle and Wheels
- 2.5" Titanium Driver
- 15" Woofer with 2" ASV Voice Coil
- Impedance: 8 Ohms
- Frequency Range: 45Hz-20KHz
- Maximum Power: 500W
- Input: Speak-On
- Magnet: 40 Oz.
- Dimensions: 450x355x685mm 17.7" x 14" x 27"
- Weight: 11Kg (24.2 lbs)



**DJAP-1567A-CMB**

**PROFESSIONAL ACTIVE LOUDSPEAKER**

- Wireless Music Stream
- 2-Way Configuration with Active Filter, Amplifier
- Wireless Remote Control
- 2.5" Titanium Driver
- 15" Woofer with 2" ASV Voice Coil
- Class A/B Amplifier, Memory Stick/Memory Card Host
- Impedance 8 Ohms
- Frequency Range: 45Hz - 20,000Hz
- 2-Way Mic Input (XLR/1/4" Jack) Line Input (RCA), Line Output RCA
- Maximum Power: 600W
- Power Source: 115V/230V
- Magnet: 40 Oz.
- Dimensions: 17.7" x 14" x 27"
- Weight: 31.5 Lbs



**Wheels for easy Transportation**



**15" TWO WAY ACTIVE LOUDSPEAKER PACKAGE WITH TRIPOD, MICROPHONE, & WIRELESS REMOTE CONTROL**

**DJAP-1577BUSB**

**BUILT-IN AMPLIFIER**

- With USB and SD Card Reader
- 2-Way Configuration with Active Filter
- 4.5 Titanium Driver
- 15" Woofer with 3" ASV Voice Coil
- Class AB Amplifier: USB Host/SD MP3
- Impedance: 8 Ohms
- Frequency Range: 40Hz - 20kHz
- 2-Way Microphone Input
- Maximum Power: 500 Watts
- Power Source: 115V / 230V
- Magnet: 70 Oz.
- Steel Basket Woofer
- High Wattage Powered Class A/B Amplifier
- Stand Mounting Socket
- Auxiliary Line Output
- Metal Grill
- High Temperature Voice Coil
- Rubber Feet
- Easy Carry Handles
- Stacking Grooves
- USB HOST/SD MP3
- Weight: 23.5kg (52 lbs)
- Dimension: 465 x 420 x 680mm  
 18.3" x 16.5" x 26.8"



**DJAP-1579SLV**

**PROFESSIONAL PASSIVE LOUDSPEAKER**

- 2-Way Configuration with Active Filter, a Handle and Wheels
- 4.5" Titanium Driver
- 15" Woofer with 3" ASV Voice Coil
- Impedance: 8 Ohms
- Frequency Range: 40Hz - 20kHz
- Maximum Power: 700W
- Input: Speak-On
- Magnet: 70 Oz.
- Dimensions: 480 x 410 x 710mm
- Weight: 20kg (44 lbs)



**Included:**  
**15FT Speak-On Cable**

**DJAP-1580BT**

**PROFESSIONAL ACTIVE LOUDSPEAKER**

- Wireless Music Stream
- 2-Way Configuration with Active Filter, Amplifier, a Handle and Wheels
- Wireless Remoter Control
- FM Tuner
- Line Output Allows Linking of Additional Enclosure
- 4.5" Titanium Driver
- 15" Woofer with 3" KSV Voice Coil
- Class AB Amplifier, USB Host/SD MP3
- 3.5mm Stereo Plug to RCA Plug Included
- Impedance: 8 Ohms
- Frequency Range: 40Hz - 20kHz
- 2-Way Mic Input (XLR/1/4" Jack), Line Input (XLR/RCA), 2 Band EQ (80Hz, 12kHz), Link Output XLR/1/4" Jack
- Maximum Power: 700W
- Power Source: 115V / 230V
- Magnet: 70 Oz.
- Dimensions: 480 x 410x 710mm
- Weight: 25.5kg (56.2 lbs)



**Wireless  
Remote  
Control**



**Wireless  
Music Stream**



**Included:  
6FT 3.5mm to RCA Cable**

**DJAP-1580BTAMP**

**REPLACEMENT AMPLIFIER**

- Replacement Amplifier for DJAP-1580BT



**DJAP-1593BT**

**WIRELESS MUSIC STREAM**

- 2-Way Configuration with Active Filter, Amplifier, a Handle and Wheels
- Line Output Allows Linking of Additional Enclosure
- 4.5" Titanium Driver
- Frequency Range: 40Hz - 20KHz
- 15" Woofer with 3" KSV Voice Coil
- Magnet: 93 Oz.
- Impedance: 8 Ohms
- Class A/B Amplifier, USB Host/SD MP3
- 2-Way Mic Input (XLR/ ¼" Jack), Line Input (XLR/RCA), 2 Band EQ (80Hz, 12kHz), Line Output XLR / 1/4" Jack
- Maximum Power: 1000W
- Power Source: 115V / 230V
- Dimensions: 465 x 430 x 700mm  
18.3" x 16.9" x 27.6"
- Weight: 22.5kg (49.6 lbs)



**DJAP-D1550UB**

**2-WAY CONFIGURATION WITH ACTIVE FILTER, AMPLIFIER**

- Wireless Remote Control
- 4.5" Titanium Driver
- Double 15" Woofer with 2.5" KAPTON Voice Coil
- Class A/B Amplifier
- USB Host/SD MP3
- Frequency Range: 40Hz - 20KHz
- 2-Way Mic Input (XLR/1/4" Jack) Line Input (XLR/RCA) Line Output (XLR/1/4" Jack)
- Maximum Power: 800W
- Power Source: 115V/230V
- Magnet: 50 Oz.
- Dimensions: 450 x 345 x 1100mm  
17.7" x 13.6" x 43.3"
- Weight: 26kg (57.3 lbs)



**DJAP-18601**

**PROFESSIONAL ACTIVE LOUDSPEAKER**

- Subwoofer with Active Filter 18" Subwoofer
- Subwoofer Frequency Response: 30Hz - 180Hz ± 3dB
- Satellite Frequency Response: 180Hz - 20KHz ± 3dB
- Line Input: XLR / RCA
- Line Output: XLR / RCA
- Maximum Power: 500W
- Power Voltage: AC115V & AC230V
- Dimensions: 27.2" x 21.9" x 24.2"
- Net Weight: 37.5kg (83Lbs)



**QB-1000BT**

**BAR CUBE POWER AMPLIFIER**

- Monoblock Class A/B Amplifier, USB Host / SD MP3
- Mono Channel Operation
- Total Peak Power Output: 600 Watts
- RMS Power Rating: 4 Ohms: 300W x 1 Channel
- THD at Rated RMS Power 0.5%
- Signal-to-Noise Ratio 60dB
- Frequency Response: 20Hz - 22kHz
- Dimensions: 9.7"L x 7.3"W x 8"H
- 2-Way Mic Input (XLR/ 1/4" Jack) Line Input (XLR / RCA)
- 2 Band EQ (80Hz,12kHz) Output XLE/RCA
- Power Source: 115/230V
- Dimensions (WxDxH): 10" x 7.5" x 8.5"

Designed to power  
2 passive Enclosures



Not Included

Not Included



**Bluetooth**  
**600 Watts**

**MSA-12**

**P.A. SPEAKER STAND WITH  
P.A. SPEAKER HOLDER**

- Stand with P.A. Speaker Holder
- Height Adjustment Grip
- Carry Bag
- Product Parameter:  
Height: 39.4" - 74.8"  
(1000-1900mm)  
Weight: 6.7Lbs (3.05Kg)



**EX-PRO312-25BLK**

**3 OUTLET 25' HEAVY-DUTY  
EXTENSION CORD**

**EX-PRO312-50BLK**

**3 OUTLET 50' HEAVY-DUTY  
EXTENSION CORD**

- Tangle-Free and Ultra-Flexible
- Great for Indoor/Outdoor use around the House, Garage and many other places
- 3 Ground Outlets



Now stronger than ever,  
this heavy duty extension  
cord is a must have  
accessory for your PA  
cabinet, disco lighting, or  
any electrical application.



15A/125V

50'/15.2M

12 Gauge

**DDP-670T-BLK**

**2-WAY WEATHERPROOF PROFESSIONAL MONITOR SPEAKER**

- 6.5" 2-Way
- 6.5" Monitor Speaker
- Max Power: 100 Watts
- Sensitivity: 90 dB
- Impedance: 8 Ohms
- Frequency Response: 55-20KHz
- 3 Year UV Resistant Housing
- Anti-corrosive, Water Resistant Alluminum Grill
- LED Flashes to the music
- Gross Weight: 7.05 lbs.
- Available in black or White
- Dimension: 8.3" x 7.3" x 12.2"
- 15 Watt Multi-Tap Transformer for 70V Distributed Speaker Lines
- Sold Individually



**15 WATTS MULTI-TAP TRANSFORMER FOR 70V DISTRIBUTED SPEAKER LINES**



**100 Watts Max**



**DDP-670T-WHT**

**2-WAY WEATHERPROOF PROFESSIONAL MONITOR SPEAKER**

- 6.5" 2-Way
- 6.5" Monitor Speaker
- Max Power: 100 Watts
- Sensitivity: 90 dB
- Impedance: 8 Ohms
- Frequency Response: 55-20KHz
- 3 Year UV Resistant Housing
- Anti-corrosive, Water Resistant Aluminum Grill
- LED Flashes to the music
- Gross Weight: 7.05 lbs.
- Available in black or White
- Dimension: 8.3" x 7.3" x 12.2"
- 15 Watt Multi-Tap Transformer for 70V Distributed Speaker Lines
- Sold Individually



**15 WATTS MULTI-TAP TRANSFORMER FOR 70V DISTRIBUTED SPEAKER LINES**

**100 Watts Max**

- 1 OFF
- 2 2.5 WATT
- 3 5 WATT
- 4 10 WATT
- 5 15 WATT



**ODP-853-BLK**

**ODP-853-WHT**

INDOOR/OUTDOOR WEATHERPROOF LOUDSPEAKER

- 8" 2-Way
- 8" Monitor Speaker
- Max Power: 240 Watts
- Sensitivity: 90 dB
- Impedance: 8 Ohms
- Frequency Response: 45-20KHz
- 3 Year UV Resistant Housing
- Anti-corrosive, Water Resistant Aluminum Grill
- LED Flashes to the music
- Gross Weight: 5 KG
- Color: Black & White
- Dimension: 9.5" x 9.3" x 14" (240x236x355 mm)
- Sold in pair



**ODP-870T-BLK**

**ODP-870T-WHT**

INDOOR/OUTDOOR WEATHERPROOF LOUDSPEAKER

- 8" 2-Way
- 8" Monitor Speaker
- Max Power: 240 Watts
- Sensitivity: 90 dB
- Impedance: 8 Ohms
- Frequency Response: 45-20KHz
- 3 Year UV Resistant Housing
- Anti-corrosive, Water Resistant Aluminum Grill
- LED Flashes to the music
- Gross Weight: 5 KG
- Available in Black or White
- Dimension: 9.5" x 9.3" x 14" (240x236x355 mm)
- 30 Watts Multi-Tap Transformer for 70V Distributed Speaker Lines
- Sold Individually



**240 Watts Max**

**15 WATTS MULTI-TAP TRANSFORMER FOR 70V DISTRIBUTED SPEAKER LINES**

- 1 OFF**
- 2 5 WATT**
- 3 10 WATT**
- 4 20 WATT**
- 5 30 WATT**



# PROFESSIONAL SUBWOOFER

## DJAP-SUB1501

### PROFESSIONAL ACTIVE SUBWOOFER

- 15" Subwoofer with Active Filter
- Frequency Response: 43-130Hz
- 2.5" Voice Coil
- Line Input: Combo/XLR
- Line Output: XLR
- Max Power: 1200 Watts
- Weather and scratch resistant texture spray painted MDF
- Black Metal Grill
- Power Voltage: AC115V & AC230V
- Dimensions: 22.8" x 18.9" x 17.7"
- Net Weight: 64 Lbs

# 15"



**BUILT-IN  
COOLING FAN**



# 1200 Watts Max

PROFESSIONAL  
**BASS**  
SERIES



**CARRYING  
HANDLES**



**EASY-MOUNT  
HOLE**



**QUICK CONNECT:  
SPEAK-ON INPUT**



**RUBBER FEET**



**PROFESSIONAL SUBWOOFER**

**DJAP-SUB1801**

**PROFESSIONAL ACTIVE SUBWOOFER**

- 18" Subwoofer with Active Filter
- Frequency Response: 40-130Hz
- 4" Voice Coil
- Line Input: Combo/XLR
- Line Output: XLR
- Max Power: 1400 Watts
- Weather and scratch resistant texture spray painted MDF
- Black Metal Grill
- Power Voltage: AC115V & AC230V
- Dimensions: 26" x 20.3" x 21"
- Net Weight: 86 Lbs

**18"**



**BUILT-IN  
AMPLIFIER**



**1400 Watts Max**

PROFESSIONAL  
**BASS**  
SERIES



**COOLING  
FAN**



**EASY-MOUNT  
HOLE**



**QUICK CONNECT:  
SPEAK-ON INPUT**



**RUBBER FEET**

**MS-PE42**

**UNIVERSAL SPEAKER POLE EXTENDER**

- 35MM (1.375") diameter
- Total height: 1.1 meters (43.3")

**DESIGNED TO MOUNT SPEAKERS ONTO  
SUBWOOFER CABINETS WITH  
TOP MOUNT HOLE.**



**SPEAKER NOT  
INCLUDED**



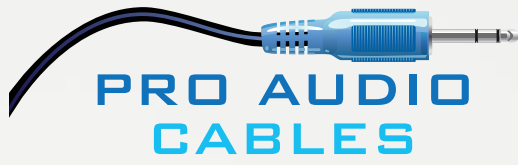

*2022 CATALOG*



**FBC-3 (3')**

**FBC-6 (6')**

**FBC-10 (12')**

**FBC-18 (18')**

**INSTRUMENT CABLE**

- 1/4" to 1/4" Mono
- Black



**FCC-18BLS**

**1/4" TO 1/4"  
INSTRUMENT CABLE**

- Tweed/ 7.4mm
- 18'
- Shrink Tubing Gold Tip Plug
- Black & Silver Cotton Woven Exterior Cover



**FS-620 (20')**

**SPEAKER CABLE**

- 1/4" to 1/4"
- Clear



**FS-650 (50')**

**SPEAKER CABLE**

- 1/4" to 1/4"
- Clear

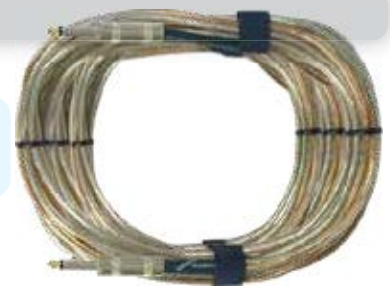

**FX-714P-F60 (20')**

**FX-714P-F60 30F (20')**

**FX-714P-P35 (6')**

**MICROPHONE CABLE**

- 3 Pin Female XLR to 1/4"
- 1/4" Plug to 3.5mm
- Black



**FX-720 (20')**

**FX-750 (50')**

**INSTRUMENT CABLE**

- 1/4" to 1/4"
- Black



**FX-7M60-14-6 (6')**

**FX-7M60-14-20 (20')**

**FX-7M60-14-50 (50')**

**INSTRUMENT CABLE**

- 1/4" TO XLR female Premium instrument cable
- Black



**FXB-3514-6 (6')**

**FXB-3514-12 (12')**

**INSTRUMENT CABLE**

- 3.5mm Plug to 1/4" Plug
- Ø 6.3mm
- Black



**PRO AUDIO  
CABLES**

**CABLES**

- FX-7M60-F60-3 (3')**
- FX-7M60-F60-6 (6')**
- FX-7M60-F60-20 (20')**
- FX-7M60-F60-50 (50')**
- FX-7M60-F60-75 (75')**

**MICROPHONE CABLE**

- 3 Pin Male XLR to 3 Pin Female XLR
- Black



- FXB-3514M-12 (12')**
- FXB-3514M-18 (18')**

**ACCESSORY CABLES**

- 3.5MM PLUG TO 1/4" Mono Plug
- Black



**FXC-61414**

**JUMPER CABLES FOR  
GUITAR PEDALS**

- 6 Color Coded: Red, Blue, Yellow, Green, Black & Purple



**MC-5-500WV**

**MICROPHONE CABLE  
WITH WOVEN JACKET**

- 500'
- 20 Gauge
- Stereo



**MC-10**

**MICROPHONE CABLE**

- 20'
- 1/4" Plug to 3 Pin XLR Jack



**MC-10-10**

**MICROPHONE CABLE**

- 10'
- 3 Pin XLR Female to 1/4" Male



**MC-14-3 (3')**

**MC-14-6 (6')**

**MC-14-12 (12')**

**MC-14-20 (20')**

**MC-14-30 (30')**

**PRO AUDIO-INSTRUMENT CABLE**

- 1/4" to 1/4" Heavy-Duty 20 Gauge Pro Audio Cable
- Single Plug Works Great for many Instrument Connections
- Low Resistance and Maximum Signal Transfer
- Durable yet Flexible, Black PVC Outer Jacket
- Heavy-Duty Metal Shell Connectors for a Reliable Connection



- MC-20-3 (3')
- MC-20-6 (6')
- MC-20-12 (12')
- MC-20-20 (20')
- MC-20-30 (30')
- MC-20-50 (50')



**MICROPHONE CABLE**

- 3 Pin XLR Plug to 3 Pin XLR Jack

- MC-30-6 (6')
- MC-30-12 (12')
- MC-30-30 (30')



**MICROPHONE CABLE**

- 1/4" Mono Plug to 3 Pin XLR Plug

**N-110E**

**RED INSTRUMENT CABLE**

- 10'
- 1/4" Plug to 1/4" Plug with Gold Tips



**N-120E**

**RED INSTRUMENT CABLE**

- 20'
- 1/4" Plug to 1/4" Plug with Gold Tips



**N-130E**

**BLUE INSTRUMENT CABLE**

- 10'
- 1/4" Plug to 3 Pin Female XLR with Gold Tip



**N-140E**

**BLUE INSTRUMENT CABLE**

- 20'
- 1/4" Plug to 3 Pin Female XLR with Gold Tip



**N-112CL (10')**

**N-122CL (20')**

**PROFESSIONAL WOVEN INSTRUMENT CABLE**

- 1/4" to 1/4" with Gold Tips
- High Heat Protection



**N-122-MF60**

**WOVEN MICROPHONE CABLE**

- 20'
- 3 Pin Female XLR to 3 Pin Male XLR



**PRO AUDIO  
CABLES**

**CABLES / CONNECTORS**

**N-150 (10')**

**INSTRUMENT CABLE**

- 1/4" to 1/4" Angled



**N-170E (10')**

**N-180E (20')**

**MICROPHONE CABLE**

- 3 Pin Male to 3 Pin Female



**N-200**

**INSTRUMENT CABLE**

- 1/4" to 1/4"
- Shielded
- 20'



**N-234-6 (6')**

**N-234-12 (12')**

**MONO PLUG**

- 3.5mm to 1/4"
- Black



**N-251 (10')**

**N-252 (20')**

**INSTRUMENT CABLE**

- 1/4" to 1/4"
- Gold Tips



**F-70**

**TERMINAL**

- 3 Pins
- Female
- Metal



**X-1067**

**TERMINAL**

- 3 Pins
- XLR Female
- Plastic



**X-1068**

**TERMINAL**

- 3 Pins
- XLR Male
- Plastic



**X-1091**

**TERMINAL**

- 8 Pins
- SPK Female
- Plastic



**X-1092**

**TERMINAL**

- 4 Pins
- SPK Female
- Plastic



**X-1097**

**TERMINAL**

- 4 Pins
- SPK Female
- Plastic



**X-1098**

**TERMINAL**

- 4 Pins
- SPK Female
- Plastic



**X-1103**

**CONNECTOR**

- SPKN Male
- 8 Pins



**X-1136**

**CONNECTOR**

- 1/4" Female to SPKN Male



**X-1142**

**CONNECTOR**

- SPKN Plug Coupler



**XMP-1095**

**CONNECTOR**

- 4-Pin Male Cable Mount SPKN Connector
- Professional Audio Connector Commonly used to Connect Speakers to a Powered Amplifier
- Connector Body Unscrews for Easy Assembly with no Soldering Required
- Compact Design with Durable Metal Shell, and Chuck Type Strain Relief for Secure Clamping of all Cables
- Reliable, Easy to Assemble and Improves Contact Integrity as well Cable Strain Relief



**XMP-1094**

**CONNECTOR**

- 4-Pin Female Cable Mount SPKN Connector
- These Connectors are the Standard Chassis Connectors for Loudspeaker / Amplifier Interconnections
- Precise Keyway for Secure Mating
- They Feature a Unique Metal Locking System, Making Contact Only Once Fully Locked. The SpeakON Receptacles are Robust, Versatile and Easy to Terminate
- Reliable, Easy to Assemble and Improves Contact Integrity as well Cable Strain Relief





**PRO AUDIO  
CABLES**

**CONNECTORS**

**X-1001**

**CONNECTOR**

- XLR Female with Nickel Finish
- 3 Pins



**X-1002**

**CONNECTOR**

- XLR Male with Nickel Finish
- 3 Pins



**X-1088**

**CONNECTOR**

- SPKN Type Male Plug
- 4 Pins
- Economy Type



**X-1089**

**CONNECTOR**

- SPKN Type Female Plug
- 4 Pins



**X-1090**

**CONNECTOR**

- SPKN Male
- 4 Pins



**X-1090B**

**CONNECTOR**

- SPKN Male Plug
- 4 Pins



**X-1090L**

**CONNECTOR**

- SPKN Plug
- 4 Pins
- Right Angle



**MX-71 BLK**

**CONNECTOR**

- Connector 3-PINS XLR male
- Black Color



**MX-73 BLK**

**CONNECTOR**

- Connector 3 Pins male XLR
- Hexagon Cap
- Color Black



**MX-73 BLU**

**CONNECTOR**

- Connector 3 Pins male XLR
- Hexagon Cap
- Color Blue



**MX-73 RED**

**CONNECTOR**

- Connector 3-Pin male XLR
- Hexagon Cap
- Color Red



**MX-75**

**CONNECTOR**

- Connector 3-PIN male XLR
- Metal Cap
- Ring Color Available in: Blue, Green, White, Yellow and Red





**P-193**

**CONNECTOR**

- Connector 1/4" female stereo
- Metal Finish



**P-195**

**CONNECTOR**

- Connector 1/4" female stereo terminal
- Metal Finish



**F-60**

**CONNECTOR**

- XLR female



**F-67**

**CONNECTOR**

- XLR Female to 1/4" Mono Plug



**FX-61 BLK**

**CONNECTOR**

- XLR Female
- Metal Cap
- Black



**FX-63**

**CONNECTOR**

- XLR Female
- Metal Cap



**FX-61**

**CONNECTOR**

- XLR Female
- Metal Cap
- Includes Rings: Black, Blue, Green, Red, Yellow and White



**FX-71 BLK**

**CONNECTOR**

- XLR Female



**FX-73 BLK**

**CONNECTOR**

- 3 Pins Female XLR
- Hexagon Cap
- Color: Black



**FX-73 BLU**

**CONNECTOR**

- 3 Pins Female
- Hexagon Cap
- Color: Blue



**FX-73 RED**

**CONNECTOR**

- 3 Pins Female
- Hexagon Cap
- Color: Red



**FX-75**

**CONNECTOR**

- 3 Pins Female
- Metal Cap
- Includes Rings: Black, Blue, Green, Red, Yellow and White





**PRO AUDIO  
CABLES**

**CONNECTORS**

**M-60**

**CONNECTOR**

- XLR
- Male



**M-67**

**CONNECTOR**

- 3 Pins Male to 1/4" Plug



**M-68**

**CONNECTOR**

- 3 Pins
- Male XLR to Male XLR



**M-70**

**CONNECTOR**

- 3 Pins
- Male XLR Terminal



**M-77**

**CONNECTOR**

- XLR Male to 1/4" Female



**M-78**

**CONNECTOR**

- 3 Pins
- Female XLR to Female XLR



**M-80**

**CONNECTOR**

- Microphone Connector 3Pin/Male
- XLR / 1/4" Dual Purpose Socket



**MX-61**

**CONNECTOR**

- 3 Pins Male XLR
- Metal Cap
- Includes Rings: Blue, Black, Green, Yellow, Red and White



**MX-63**

**CONNECTOR**

- 3 Pins Male XLR
- Metal Cap



**MX-61 BLK**

**CONNECTOR**

- 3 Pins Male XLR
- Metal Cap
- Black



**X-1132**

**CONNECTOR**

- 1/4" Mono Male
- Nickel Finish
- Gold Tip
- Connects Cable which is between Ø 6~7mm
- Includes 3 Additional Color Code Bands



**X-1132 BLK**

**CONNECTOR**

- 1/4"
- Mono Male
- Nickel Finish
- Gold Tip
- Connects Cable which is between Ø 6~7mm
- Black Color



**X-1132 BLU**

**CONNECTOR**

- 1/4"
- Mono Male
- Nickel Finish
- Gold Tip
- Connects Cable which is between Ø 6~7mm
- Blue Color



**X-1132 RED**

**CONNECTOR**

- 1/4"
- Mono Male
- Nickel Finish
- Gold Tip
- Connects Cable which is between Ø 6~7mm
- Red Color



**P-180 BLU**

**P-180 RED**

**CONNECTOR**

- Professional plug 1/4"
- Mono
- Available in Black and Red



**P-181 BLK**

**CONNECTOR**

- Professional plug 1/4" color coded
- Stereo
- Available in Black, Blue and Red



**X-1133**

**CONNECTOR**

- 1/4"
- Stereo Male
- Nickel Finish
- Gold Tip
- Connects Cable which is between Ø 6~7mm



**X-1141**

**CONNECTOR**

- 1/4" Plug Coupler
- Nickel Finish



**X-1143**

**CONNECTOR**

- 1/4" Plug Coupler Stereo
- Nickel Finish



**X-571**

**CONNECTOR**

- 1/4"
- Mono Silver Tip
- Nickel Finish
- Bakelite



**X-591G**

**CONNECTOR**

- 1/4"
- Mono Gold Tip
- Nickel Finish



**X-571G**

**CONNECTOR**

- 1/4"
- Mono Gold Tip
- Nickel Finish
- Bakelite



**PRO AUDIO  
CABLES**

**CONNECTORS**

**X-601**

**CONNECTOR**

- 1/4"
- Mono Male
- Nickel Finish
- Heavy Duty
- Bakelite



**X-602**

**CONNECTOR**

- 1/4"
- Stereo Male
- Nickel Finish
- Heavy Duty
- Gold Tip



**X-631GB**

**CONNECTOR**

- 1/4"
- Mono Gold Tip
- Bakelite



**ZA-XLRF-RCAF**

**CONNECTOR**

- 3-Pin XLR Female to RCA Female Jack
- Connects an Unbalanced RCA Female Head to a Balanced XLR Female



**ZA-XLRM-RCAF**

**CONNECTOR**

- 3-Pin XLR Male to RCA Female Jack
- Connects an Unbalanced RCA Female Head to a Balanced XLR Female



**ZA-XLRF-RCAM**

**CONNECTOR**

- 3-Pin XLR Female to RCA Male Jack
- Connects an Unbalanced RCA Male Head to a Balanced XLR Female



**ZA-XLRF-XLRF**

**CONNECTOR**

- XLR Female to XLR Female Coupler
- In-Line Balanced 3-Pin XLR Adapter Joins Two XLR Male Connectors



**ZA-XLRM-RCAM**

**CONNECTOR**

- 3-Pin XLR Male to RCA Male Jack
- Connects an Unbalanced RCA Male Head to a Balanced XLR Male



**ZA-XLRM-XLRM**

**CONNECTOR**

- XLR Male to XLR Male Coupler
- In-Line Balanced 3-Pin XLR Adapter Joins Two XLR Female Connectors



**ZP-14MN**

**MONO TIP**

- 1/4"



**ZP-14MN-RA**

**MONO GOLD TIP**

- 1/4"
- Right Angle



**ZP-14MN-PG**

**MONO GOLD TIP**

- 1/4"
- Gold-Plated

**ZP-35MN-P**

**MONO PLUG**

- 3.5mm Mono Plug



**ZP-35ST-P**

**STEREO PLUG**

- 3.5mm Stereo Plug



**MC-4 BLU**

**MICROPHONE CABLE**

- 500 FT. (152.4 meters)
- Color: Blue
- Flexible PVC
- 100% Copper
- Braided for High Shielding
- Stereo
- $\Phi$  0.26" / 6.7mm



**MC-4 BLK**

**MICROPHONE CABLE**

- 500 FT. (152.4 meters)
- Color: Black
- Flexible PVC
- 100% Copper
- Braided for High Shielding
- Stereo
- $\Phi$  0.26" / 6.7mm



**MC-4 RED**

**MICROPHONE CABLE**

- 500 FT. (152.4 meters)
- Color: Red
- Flexible PVC
- 100% Copper
- Braided for High Shielding
- Stereo
- $\Phi$  0.26" / 6.7mm



**MC-4 YLW**

**MICROPHONE CABLE**

- 500 FT. (152.4 meters)
- Color: Yellow
- Flexible PVC
- 100% Copper
- Braided for High Shielding
- Stereo
- $\Phi$  0.26" / 6.7mm



**TMC-4 BLK**

**MICROPHONE CABLE**

- 100% Copper wires
- Stereo
- 500 Ft. (152.4 m)
- Flexible PVC
- Braided for high shielding
- $\Phi$  0.24" ( $\Phi$  6.2 mm)





**PRO AUDIO  
CABLES**

**ACCESSORIES**

**AHS-3514-4**

**PORTABLE 4-WAY HEADPHONE AMPLIFIER**

- Material: Metal
- Color: Black
- Input Connector: stereo 1/8 inch TRS jack, Stereo 1/4 inch TRS jack, RCA stereo connector
- Input Impedance: 22K ohm
- Max. Input Level: +22dB
- Output Connectors: stereo 1/8 inch TRS jack, Stereo 1/4 inch TRS jack
- Output Impedance: min. 16 ohm
- Max. Gain: 20dB/channel
- S/N Ratio: >98dB
- Frequency Response: 20Hz-20KHz
- THD:< 0.01%
- Power Supply: DC 5V, >=1000mA via USB power adaptor
- Item Size: 11.3 \* 7.3 \* 5.9cm / 4.4 \* 2.9 \* 2.3in
- Item Weight: 375g/ 13.2oz



**AQM-1600BT**

**6 CHANNEL MIXER WITH USB INTERFACE AND DSP EFFECTS**

- XLR Microphone & 1/4-inch instrument inputs.
- 1/4-inch TRS balanced line-level inputs.
- Unbalanced RCA inputs.
- Stereo 1/4-inch TRS headphone out with independent level control.
- 1/4-inch TRS balanced outputs.
- Low noise +48V phantom power.
- LED Meter Display & Clip Indicators.
- Switchable USB Playback assignment.
- USB 2.0 compliant / No drivers needed for Windows or Mac OS and Linux.
- USB cable, AC supply, and Audacity recording software included.



**AQM-1400BT**

**4 CHANNEL AUDIO MIXER WITH USB INTERFACE**

**Input Connections:**

- XLR & 1/4-inch Balanced Combo Jack (CH1 input).
- XLR & 1/4-inch Unbalanced Combo Jack (CH2 input).
- 1/4-inch TRS Balanced (CH3 & CH4).
- 1/8-inch TRS Aux/MP3, 1/8-inch TRRS.

**Output Connections:**

- 1/4-inch TRS Balanced Main Mix Outputs.
- 1/4-inch TRS Stereo Output & Monitor Outputs.
- 1/8th-inch Headset Output.

**Signal to Noise Ratio:**

- >90dB Typical (Ref 0dBu).

**Maximun Input Level:**

- +8dBu (Mic), +16dBu (1/4-inch input).

**Maximun Output Level:**

- +15dBu Main Mix Outputs.

**Maximun Gain:**

- +60dB(XLR), +47dB(1/4-inch) - CH1 input
- +55dB(XLR), +37dB 1/4-inch (ISTR.Hi-z)-CH2 input
- +5dB(1/4-inch) - CH3 & CH4 inputs

**USB Computer Interface:**

- USB Class Compliant plug-and-play Mac/PC Interface

**Power:**

- Via USB or 5V DC @ 500mA

**Dimensions:**

- 126mm x 185mm x 45mm

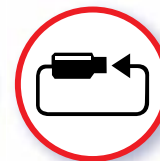



*2022 CATALOG*

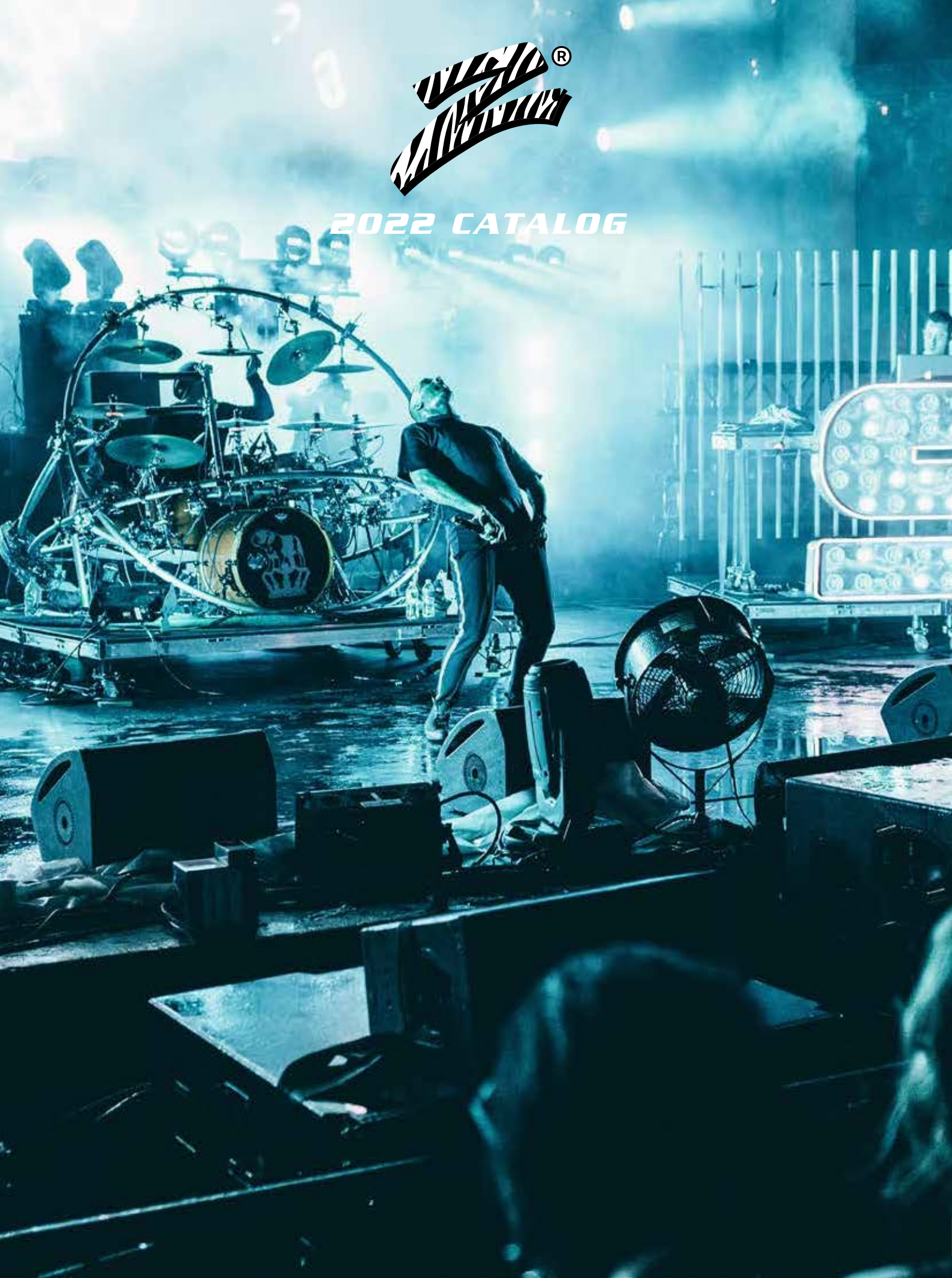





## PROFESSIONAL EQUIPMENT

### DJ-115FM

#### 15" WOOFER

- 6" x 17" Horn Tweeter
- Power Handling: 200W RMS/ 400W Maximum
- Full Metal Mesh Grill
- Impedance: 8 Ohms
- Magnet: 50 Oz.
- 2" Al Voice Coil
- Dimensions: 530 x 395 x 395 x 755 mm



### MSZ-1250

#### 15" WOOFER

- 6" x 17" Horn Tweeter
- Power Handling: 200W RMS/ 400W Maximum
- Full Metal Mesh Grill
- Impedance: 8 Ohms
- Magnet: 50 Oz.
- 2" Al Voice Coil
- Dimensions: 530 x 395 x 395 x 755 mm



### MSZ-1550

#### 15" WOOFER

- 6" x 17" Horn Tweeter
- Power Handling: 200W RMS/ 400W Maximum
- Full Metal Mesh Grill
- Impedance: 8 Ohms
- Magnet: 50 Oz.
- 2" Al Voice Coil
- Dimensions: 530 x 395 x 395 x 755 mm





**PROFESSIONAL EQUIPMENT**

**Z-20C**

**TWEETER BOX**

- Two 4" Piezo Tweeters
- Dimensions: 290 x 225 x 1160mm (11.4" x 8.8" x 6.3")
- Frequency Response: 4K-27KHz
- Maximum Power: 100W



**Z-40C**

**TWEETER BOX**

- 4-Way Tweeter System
- Carpeted Heavy Duty Construction
- Power Handling: 100W RMS/200W Peak
- Dual 1/4" Phono Jacks
- Frequency Response: 3.5K-20KHz
- SPL: 97dB (1W/1M)



**Z-70**

**TWEETER BOX**

- 7-Way DJ Tweeter System
- Six 3.5" Piezo Tweeters
- 5" x 12" Horn
- Gold Post Terminals
- Carpet Finish
- Frequency Response: 6K-29KHz
- Sensitivity: 95dB (1W/1M)
- Size: 13" x 22" x 12.5"
- Maximum Power



**Z-90**

**TWEETER BOX**

- 6-Way DJ Tweeter System
- Five 3.5" Piezo Tweeters
- 10" x 18" Horn Tweeter
- Gold Post Terminals
- Carpet Finish
- Chrome-Plated Metal Corners
- Frequency Response: 9K-31KHz
- Sensitivity: 92dB (1W/1M)
- Size: 16.75" x 22.375" x 1.25"
- Maximum Power: 400W





## MINI MIXERS

### ZMX-100

#### MINI MIXER

- 4 Mic Inputs
- 1 Line Output
- 20dB Gain
- Power Supply: DC 12V / AC 100-240V



### ZMX-200

#### MINI MIXER

- 8 Mic Inputs
- 2 Line Output
- 20dB Gain
- Power Supply: DC 12V / AC 100-240V



### ZMX-400 EFX

#### MINI MIXER

- 4 Mono 1/4" Microphone Inputs with Individual Volume Control
- Built-In Echo Effects DSP with Delay Time and Depth Control
- Simulates from Room, Hall, Stadium and Delays Reverb
- 1/4" Unbalanced Output
- Up to 50dB of Gain per Channel
- Power ON/OFF Switch with LED Indicator, 9V DC Powered with PAD
- 1 AC/DC External Adapter



*Studio-Z*<sup>®</sup>

**2022 CATALOG**



X-211-25 (25' / 7.62m)

2 WIRE SPKN TO BANANA

- 14 Gauge



X-214-15 (15' / 4.57m)

X-214-25 (25' / 7.62m)

X-214-50 (50' / 15.24m)

2 WIRE SPKN TO 1/4"

- 14 Gauge



X-352-15 (15' / 4.57m)

X-352-25 (25' / 7.62m)

X-352-50 (50' / 15.24m)

X-352-75 (75' / 22.86m)

2 WIRE SPKN MALE TO SPKN MALE

- 14 Gauge



X-371-1.5 (4.92' / 1.5m)

4 WIRE SPKN MALE TO SPKN MALE

- 14 Gauge



X-371-5 (16.40' / 5m)

4 WIRE SPKN MALE TO SPKN MALE

- 12 Gauge



X-371-15 (49.21' / 15m)

4 WIRE SPKN MALE TO SPKN MALE

- 14 Gauge



FXB-3514-6 (6 Ft.)

FXB-3514-12 (12 Ft.)

PRO AUDIO CABLE

- 3.5mm Plug to 1/4" Plug, Ø 6.3mm



IS-SNK30-10RCA

30' MULTI-PAIR CABLE

- 10 RCA Heads
- Spiral Shield: 28 x 0.12 mm
- 3 12 Gauge Power Cable (Black, Blue, Red)
- Junction Housing: 35 mm
- Total Length: 9.2 m (Including 0.4 m x 2 exposed at both ends)



# StudioZ

## PRO AUDIO CABLES

### N-110E

INSTRUMENT CABLE 1/4" TO 1/4" WITH GOLD TIPS

- 10 FT



### N-130E

INSTRUMENT CABLE 1/4" TO 3 PIN FEMALE WITH GOLD TIPS

- 10 FT



### N-140E

INSTRUMENT CABLE 1/4" TO 3 PIN FEMALE WITH GOLD TIPS

- 20 FT



### ZPC-PH35-10

DFC 3.5MM STEREO TO XLR MALE MICROPHONE CABLE

- Premium Jacket Material Provide Ease of Handling and Long Service Life
- Bright Nickel-Plated Connectors for Long Term Good Looks and Conductivity
- 24 AWG Oxygen-Free Copper Stranded Conductors for Maximum Signal Transfer



### N-112CL (10')

### N-122CL (10')

PROFESSIONAL CABLE

- 1/4" to 1/4" with Gold Tips
- High Heat Protection



### ZICM-241414M-10

10FT 1/4" TO 1/4" HEAVY-DUTY

- 24 gauge pro audio cable
- Low resistance and maximum signal transfer
- Durable yet flexible, black PVC outer jacket
- Heavy-duty metal shell connectors for a reliable connection

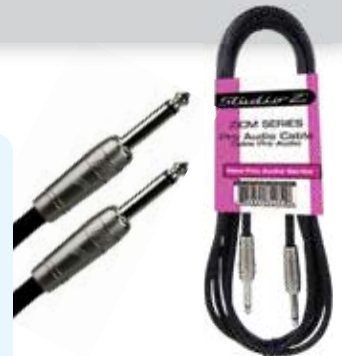

### ZICM-241414M-20

20FT 1/4" TO 1/4" HEAVY-DUTY

- 24 gauge pro audio cable
- Low resistance and maximum signal transfer
- Durable yet flexible, black PVC outer jacket
- Heavy-duty metal shell connectors for a reliable connection



### ZICM-241414M-30

30FT 1/4" TO 1/4" HEAVY-DUTY

- 24 gauge pro audio cable
- Low resistance and maximum signal transfer
- Durable yet flexible, black PVC outer jacket
- Heavy-duty metal shell connectors for a reliable connection



**XSPK-14-100** (100' / 30.48m)

**2 WIRE SPKN TO SPKN CABLES**

- 16 Gauge



**XSPK-210-250**

**4 WIRE SPKN CABLE**

- 250' / 76.2m
- 10 Gauge
- OD: Ø14mm



**XSPK-214-100**

**4 WIRE SPKN CABLE**

- 100' / 30.48m
- 14 Gauge
- OD: Ø10mm



**XSPK-214-250**

**4 WIRE SPKN CABLE**

- 250' / 76.2m
- 14 Gauge
- OD: Ø10mm



**ZICM-201414M-10**

**10FT 1/4" TO 1/4" HEAVY-DUTY**

- 20 gauge pro audio cable
- Single plug works great for many instrument connections
- Low resistance and maximum signal transfer
- Durable yet flexible, black PVC outer jacket
- Heavy-duty metal shell connectors for a reliable connection

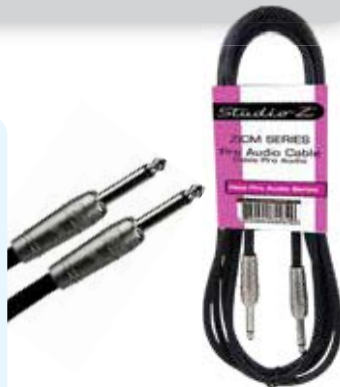

**ZICM-201414M-20**

**20FT 1/4" TO 1/4" HEAVY-DUTY**

- 20 gauge pro audio cable
- Single plug works great for many instrument connections
- Low resistance and maximum signal transfer
- Durable yet flexible, black PVC outer jacket
- Heavy-duty metal shell connectors for a reliable connection



**ZICM-201414M-30**

**PATCH CABLE 1/4" TRS MALE TO 1/4" TRS MALE**

- Premium jacket material provide ease of handling and long service life
- Bright nickel plated connectors for long term good looks and conductivity
- 20 AWG oxygen-free copper stranded conductors for maximum signal transfer



**ZICM-201414MR-10**

**10FT 1/4" TO 1/4" RIGHT ANGLE**

- 20 gauge pro audio cable
- Single right angle plug works great for many instrument connections
- Low resistance and maximum signal transfer
- Durable yet flexible, black PVC outer jacket
- Heavy-duty metal shell connectors for a reliable connection

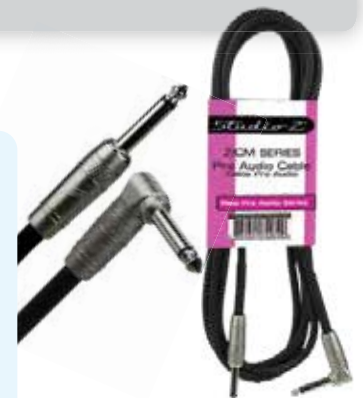

Studio Z<sup>®</sup>

PRO AUDIO CABLES

**ZICM-201414MR-20**

20FT 1/4" TO 1/4" RIGHT ANGLE HEAVY DUTY

- 20 gauge pro audio cable
- Single right angle plug works great for many instrument connections
- Low resistance and maximum signal transfer
- Durable yet flexible, black PVC outer jacket
- Heavy-duty metal shell connectors for a reliable

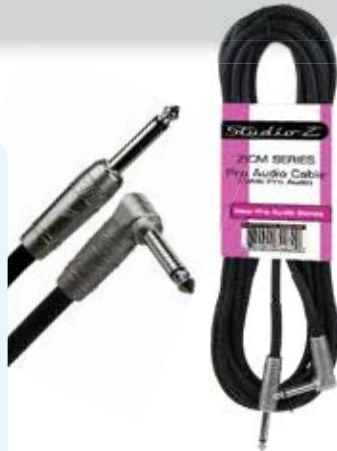

**ZICM-241414MR-10**

10FT 1/4" TO 1/4" RIGHT ANGLE HEAVY-DUTY

- 20 gauge pro audio cable
- Single right angle plug works great for many instrument connections
- Low resistance and maximum signal transfer
- Durable yet flexible, black PVC outer jacket
- Heavy-duty metal shell connectors for a reliable

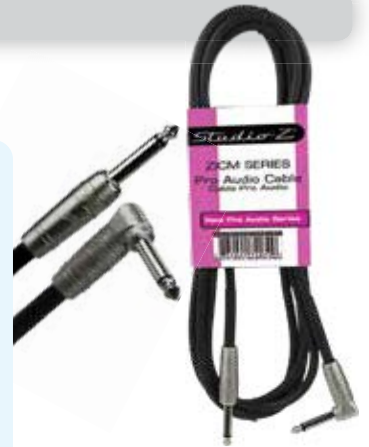

**ZICM-241414MR-20**

20FT 1/4" TO 1/4" RIGHT ANGLE HEAVY-DUTY

- 20 gauge pro audio cable
- Single right angle plug works great for many instrument connections
- Low resistance and maximum signal transfer
- Durable yet flexible, black PVC outer jacket
- Heavy-duty metal shell connectors for a reliable

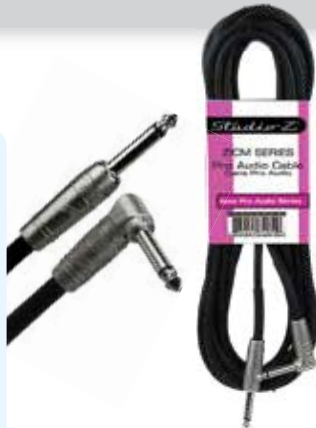

**ZICW-201414-10B**

10FT BLACK WOVEN 1/4" TO 1/4" HEAVY-DUTY

- 20 gauge pro audio cable
- Sport nylon braiding protects the cable against cuts and breaks caused by kinking, things falling on it, or things rolling over it
- Low resistance and maximum signal transfer
- Heavy-duty metal shell connectors for a reliable connection

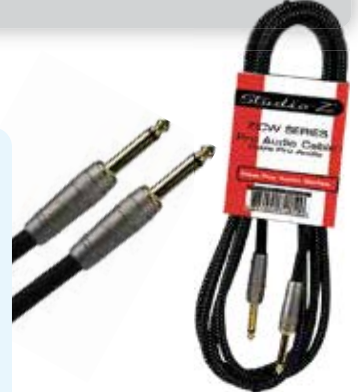

**ZICW-201414-20B**

20FT BLACK WOVEN 1/4" TO 1/4" HEAVY-DUTY

- 20 gauge pro audio cable
- Sport nylon braiding protects the cable against cuts and breaks caused by kinking, things falling on it, or things rolling over it
- Low resistance and maximum signal transfer
- Heavy-duty metal shell connectors for a reliable connection

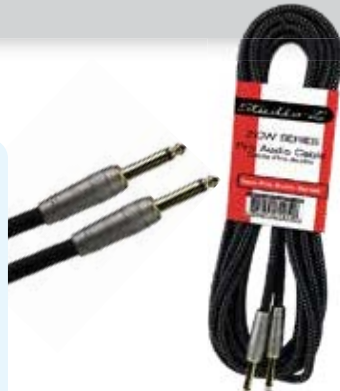

**ZICW-201414-30B**

30FT BLACK WOVEN 1/4" TO 1/4" HEAVY-DUTY

- 20 gauge pro audio cable
- Sport nylon braiding protects the cable against cuts and breaks caused by kinking, things falling on it, or things rolling over it
- Low resistance and maximum signal transfer
- Heavy-duty metal shell connectors for a reliable connection

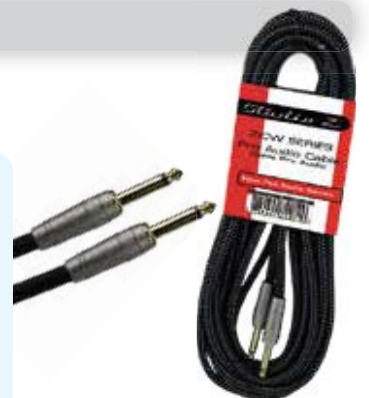



**ZICW-241414-10B**

**10FT BLACK WOVEN 1/4" TO 1/4" HEAVY-DUTY**

- 24 gauge pro audio cable
- Sport nylon braiding protects the cable against cuts and breaks caused by kinking, things falling on it, or things rolling over it
- Low resistance and maximum signal transfer
- Heavy-duty metal shell connectors for a reliable connection

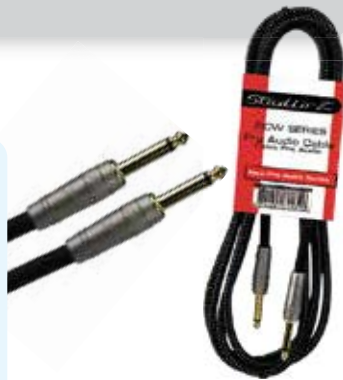

**ZICW-241414-20B**

**20FT BLACK WOVEN 1/4" TO 1/4" HEAVY-DUTY**

- 24 gauge pro audio cable
- Sport nylon braiding protects the cable against cuts and breaks caused by kinking, things falling on it, or things rolling over it
- Low resistance and maximum signal transfer
- Heavy-duty metal shell connectors for a reliable connection

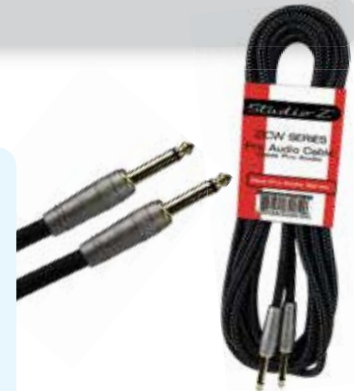

**ZICW-241414-20G**

**20FT GREEN WOVEN 1/4" TO 1/4" HEAVY-DUTY**

- 20 gauge pro audio cable
- Sport nylon braiding protects the cable against cuts and breaks caused by kinking, things falling on it, or things rolling over it
- Low resistance and maximum signal transfer
- Heavy-duty metal shell connectors for a reliable connection

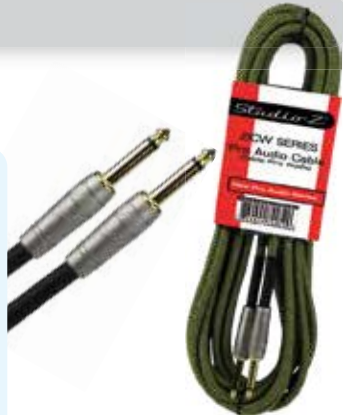

**ZICW-241414-20O**

**20FT BLACK WOVEN 1/4" TO 1/4" HEAVY-DUTY**

- 24 gauge pro audio cable
- Sport nylon braiding protects the cable against cuts and breaks caused by kinking, things falling on it, or things rolling over it
- Low resistance and maximum signal transfer
- Heavy-duty metal shell connectors for a reliable connection



**ZMC-24XMXF-6BP**

**6FT 3 PIN XLR MALE TO 3 PIN XLR FEMALE**

- 24 gauge classic microphone cable
- Black polish connector finish
- Extremely low capacitance for pure signal transparency
- Molded strain relief for ultimate durability
- Ultra-pure oxygen-free
- Durable yet flexible, black PVC outer jacket

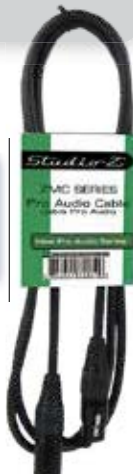

**ZMC-24XMXF-10BP**

**10FT 3 PIN XLR MALE TO 3 PIN XLR FEMALE**

- 24 gauge classic microphone cable
- Black polish connector finish
- Extremely low capacitance for pure signal transparency
- Molded strain relief for ultimate durability
- Ultra-pure oxygen-free
- Durable yet flexible, black PVC outer jacket



Studio Z<sup>®</sup>

PRO AUDIO CABLES

**ZMC-24MXF-25BP**

25FT 3 PIN XLR MALE TO  
3 PIN XLR FEMALE

- 24 gauge classic microphone cable
- Black polish connector finish
- Extremely low capacitance for pure signal transparency
- Molded strain relief for ultimate durability
- Ultra-pure oxygen-free
- Durable yet flexible, black PVC outer jacket



**ZMC-24MXF-50BP**

50FT 3 PIN XLR MALE TO  
3 PIN XLR FEMALE

- 24 gauge classic microphone cable
- Black polish connector finish
- Extremely low capacitance for pure signal transparency
- Molded strain relief for ultimate durability
- Ultra-pure oxygen-free
- Durable yet flexible, black PVC outer jacket



**ZMC-24MXF-6NP**

6FT 3 PIN XLR MALE TO  
3 PIN XLR FEMALE

- 24 gauge microphone Cable with nickel connector
- Satin nickel polish connector finish
- Extremely low capacitance for pure signal transparency
- Molded strain relief for ultimate durability
- Ultra-pure oxygen-free
- Durable yet flexible, black PVC outer jacket



**ZMC-24MXF-10NP**

10FT 3 PIN XLR MALE TO  
3 PIN XLR FEMALE

- 24 gauge microphone Cable with nickel connector
- Satin nickel polish connector finish
- Extremely low capacitance for pure signal transparency
- Molded strain relief for ultimate durability
- Ultra-pure oxygen-free
- Durable yet flexible, black PVC outer jacket



**ZMC-24MXF-25NP**

25FT 3 PIN XLR MALE TO  
3 PIN XLR FEMALE

- 24 gauge microphone Cable with nickel connector
- Satin nickel polish connector finish
- Extremely low capacitance for pure signal transparency
- Molded strain relief for ultimate durability
- Ultra-pure oxygen-free
- Durable yet flexible, black PVC outer jacket



**ZMC-24MXF-50NP**

50FT 3 PIN XLR MALE TO  
3 PIN XLR FEMALE

- 24 gauge microphone Cable w/nickel connector
- Satin nickel polish connector finish
- Extremely low capacitance for pure signal transparency
- Molded strain relief for ultimate durability
- Ultra-pure oxygen-free
- Durable yet flexible, black PVC outer jacket



**ZMCW-24XMXF-6B**

**6FT BLACK WOVEN 3PIN XLR  
MALE TO 3 PIN XLR FEMALE**

- 24 gauge pro audio cable
- Sport nylon braiding protects the cable against cuts and breaks caused by kinking, things falling on it or things rolling over it
- Molded strain relief for ultimate durability
- Extremely low capacitance for pure signal transparency



**ZMCW-24XMXF-10B**

**10FT BLACK WOVEN 3PIN XLR  
MALE TO 3 PIN XLR FEMALE**

- 24 gauge pro audio cable
- Sport nylon braiding protects the cable against cuts and breaks caused by kinking, things falling on it or things rolling over it
- Molded strain relief for ultimate durability
- Extremely low capacitance for pure signal transparency



**ZMCW-24XMXF-10G**

**10FT GREEN WOVEN 3PIN XLR  
MALE TO 3 PIN XLR FEMALE**

- 24 gauge pro audio cable
- Sport nylon braiding protects the cable against cuts and breaks caused by kinking, things falling on it or things rolling over it
- Molded strain relief for ultimate durability
- Extremely low capacitance for pure signal transparency



**ZMCW-24XMXF-10O**

**10FT ORANGE WOVEN 3PIN XLR  
MALE TO 3 PIN XLR FEMALE**

- 24 gauge pro audio cable
- Sport nylon braiding protects the cable against cuts and breaks caused by kinking, things falling on it or things rolling over it
- Molded strain relief for ultimate durability
- Extremely low capacitance for pure signal transparency



**ZMCW-24XMXF-25B**

**25FT BLACK WOVEN 3PIN XLR  
MALE TO 3 PIN XLR FEMALE**

- 24 gauge pro audio cable
- Sport nylon braiding protects the cable against cuts and breaks caused by kinking, things falling on it or things rolling over it
- Molded strain relief for ultimate durability
- Extremely low capacitance for pure signal transparency



**ZMCW-24XMXF-25G**

**25FT GREEN WOVEN 3PIN XLR  
MALE TO 3 PIN XLR FEMALE**

- 24 gauge pro audio cable
- Sport nylon braiding protects the cable against cuts and breaks caused by kinking, things falling on it or things rolling over it
- Molded strain relief for ultimate durability
- Extremely low capacitance for pure signal transparency



Studio Z

PRO AUDIO CABLES

**ZMCW-24XMXF-250**

25FT ORANGE WOVEN 3PIN XLR MALE TO 3 PIN XLR FEMALE

- 24 gauge pro audio cable
- Sport nylon braiding protects the cable against cuts and breaks caused by kinking, things falling on it or things rolling over it
- Molded strain relief for ultimate durability
- Extremely low capacitance for pure signal transparency



**ZMT-8XMXF-16BP**

MULTI-TRACK 8 CHANNELS SNAKE

- 16ft 8 channel snake 3 pin male XLR to 3 pin XLR female
- 24 gauge pro audio cable
- Snake cables provide connectivity for studios, stage rigs, and PA systems
- Channel identification markings
- Eliminate messy, expensive patch cables
- Durable yet flexible, black PVC outer jacket



**ZMT-8XMXF-33BP**

MULTI-TRACK 8 CHANNELS SNAKE

- 33ft 8 channel snake 3 pin male XLR to 3 pin XLR female
- 24 gauge pro audio cable
- Snake cables provide connectivity for studios, stage rigs, and PA systems
- Channel identification markings
- Eliminate messy, expensive patch cables
- Durable yet flexible, black PVC outer jacket



**ZPC-24D14D14-3**

DUAL HEAD PRO AUDIO CABLE

- 3ft dual 1/4" to dual 1/4" heavy-duty
- 24 gauge pro audio cable
- Low resistance and maximum signal transfer
- Durable yet flexible, black PVC outer jacket
- Heavy-duty metal shell connectors for a reliable connection



**ZPC-24D14D14-6**

DUAL HEAD PRO AUDIO CABLE

- 6ft dual 1/4" to dual 1/4" heavy-duty
- 24 gauge pro audio cable.
- Low resistance and maximum signal transfer
- Durable yet flexible, black PVC outer jacket
- Heavy-duty metal shell connectors for a reliable connection



**ZPC-24D14SD14S3**

DUAL HEAD PRO AUDIO CABLE

- 3ft dual 1/4" TRS Stereo to dual 1/4" TRS Stereo heavy-duty
- 24 gauge pro audio cable
- Low resistance and maximum signal transfer
- Durable yet flexible, black PVC outer jacket
- Heavy-duty metal shell connectors for a reliable connection

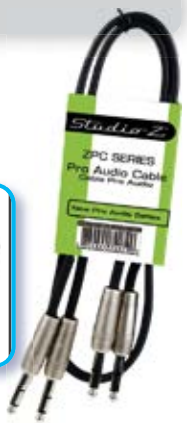

**ZPC-24RCAD14-6**

**6FT MALE DUAL RCA PLUG TO DUAL 1/4" MALE PLUG**

- 24 gauge pro audio cable
- Heavy duty metal shell connectors for reliable connection
- Gold plated RCA head for superior sound transfer
- Molded strain relief for ultimate durability
- Durable yet flexible, black PVC outer jacket



**ZPC-24RCAD14-10**

**10FT MALE DUAL RCA PLUG TO DUAL 1/4" MALE PLUG**

- 24 gauge pro audio cable
- Heavy duty metal shell connectors for reliable connection
- Gold plated RCA head for superior sound transfer
- Molded strain relief for ultimate durability
- Durable yet flexible, black PVC outer jacket



**ZPC-24XMRCA-6**

**6FT 3PIN XLR FEMALE TO 1/4" MALE PLUG**

- 24 gauge pro audio cable
- Microphone cable with nickel connector
- Extremely low capacitance for pure signal transparency
- Molded strain relief for ultimate durability
- Durable yet flexible, black PVC outer jacket



**ZPC-24XMRCA-25**

**25FT 3PIN XLR FEMALE TO 1/4" MALE PLUG**

- 24 gauge pro audio cable
- Microphone cable with nickel connector
- Extremely low capacitance for pure signal transparency
- Molded strain relief for ultimate durability
- Durable yet flexible, black PVC outer jacket



**ZPC-24XF14M-3**

**3FT 3PIN XLR FEMALE TO 1/4" MALE PLUG**

- 24 gauge pro audio cable
- Microphone cable with nickel connector
- Extremely low capacitance for pure signal transparency
- Molded strain relief for ultimate durability
- Durable yet flexible, black PVC outer jacket



**ZPC-24XF14M-6**

**6FT 3PIN XLR FEMALE TO 1/4" MALE PLUG**

- 24 gauge pro audio cable
- Microphone cable with nickel connector
- Extremely low capacitance for pure signal transparency
- Molded strain relief for ultimate durability
- Durable yet flexible, black PVC outer jacket



# Studio-Z<sup>®</sup>

## PRO AUDIO CABLES

### ZP-Y24XMPRCA-5

**Y-ADAPTER 3 PIN XLR MALE  
DUAL RCA**

- Premium jacket materials provide ease of handling and long service life.
- Gold plated tip for bright finish and product endurance.
- 24 AWG oxygen-free copper stranded conductors for maximum signal transfer.



**5'**



### ZPC-20RCA14M-6

**DUAL MALE RCA TO 1/4" MALE  
PRO AUDIO CABLE**

- Premium jacket materials provide ease of handling and long service life.
- Nickel plated connectors for bright finish and product endurance.
- 20 AWG oxygen-free copper stranded conductors for maximum signal transfer.



**6'**



### ZPC-35S14M-10

**MONO INTERCONNECT 1/4" TS TO 3.5MM TRS**

- Premium jacket materials provide ease of handling and long service life.
- Bright nickel plated connectors for long term good looks and conductivity.
- 26 AWG oxygen-free copper stranded conductors for maximum signal transfer.



**10'**



### ZPC-35S14M-25

**MONO INTERCONNECT 1/4" TS TO 3.5MM TRS**

- Premium jacket materials provide ease of handling and long service life.
- Nickel plated connectors for bright finish and product endurance.
- 26 AWG oxygen-free copper stranded conductors for maximum signal transfer.



**25'**



### ZPC-35S14M-6

**MONO INTERCONNECT 1/4" TS TO 3.5MM TRS**

- Premium jacket materials provide ease of handling and long service life.
- Nickel plated connectors for bright finish and product endurance.
- 26 AWG oxygen-free copper stranded conductors for maximum signal transfer.



**6'**



### ZPC-24XF14M-10

**10FT 3PIN XLR FEMALE TO 1/4" MALE PLUG**

- 24 gauge pro audio cable
- Microphone cable with nickel connector
- Extremely low capacitance for pure signal transparency
- Molded strain relief for ultimate durability
- Durable yet flexible, black PVC outer jacket

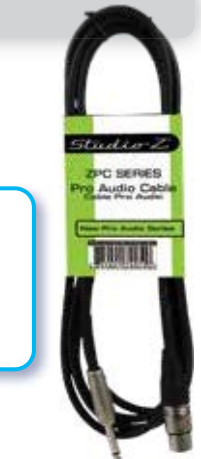

**ZPC-24XM14S-3**

**3FT 3PIN XLR MALE TO ¼" TRS STEREO MALE PLUG**

- 24 Gauge Pro Audio Cable
- Microphone Cable with Nickel Connector
- Extremely Low Capacitance for Pure Signal Transparency
- Molded Strain Relief for Ultimate Durability
- Durable yet Flexible, Black PVC Outer Jacket



**ZPC-24XM14S-6**

**6FT 3PIN XLR MALE TO ¼" TRS STEREO MALE PLUG**

- 24 Gauge Pro Audio Cable
- Microphone Cable with Nickel Connector
- Extremely Low Capacitance for Pure Signal Transparency
- Molded Strain Relief for Ultimate Durability
- Durable yet Flexible, Black PVC Outer Jacket

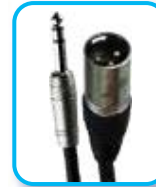

**ZPC-24XM14S-10**

**10FT 3PIN XLR MALE TO ¼" TRS STEREO MALE PLUG**

- 24 Gauge Pro Audio Cable
- Microphone Cable with Nickel Connector
- Extremely Low Capacitance for Pure Signal Transparency
- Molded Strain Relief for Ultimate Durability
- Durable yet Flexible, Black PVC Outer Jacket



**ZPC-24XM14S-25**

**25FT 3PIN XLR MALE TO ¼" TRS STEREO MALE PLUG**

- 24 Gauge Pro Audio Cable
- Microphone Cable with Nickel Connector
- Extremely Low Capacitance for Pure Signal Transparency
- Molded Strain Relief for Ultimate Durability
- Durable yet Flexible, Black PVC Outer Jacket



**ZPC-Y14S14DMN-3**

**3FT Y-ADAPTER ¼" TRS STEREO MALE TO DUAL ¼" MALE**

- 24 Gauge Pro Audio Cable
- Allows you to Connect One ¼" TRS Male to Two ¼" Male Outputs
- Low Resistance for Maximum Signal Transfer
- Heavy-Duty Metal Shell Connectors for a Reliable Connection



**ZP-XLRFXLRF-1.5**

**1.5FT 3PIN XLR FEMALE TO XLR FEMALE CABLE WITH NICKEL CONNECTOR**

- Extremely Low Capacitance for Pure Signal Transparency
- Molded Strain Relief for Ultimate Durability
- Durable yet Flexible, Black PVC Outer Jacket



**ZP-YXLRM14D**

**6" Y-ADAPTER 3PIN XLR MALE TO DUAL 1/4" TRS STEREO MALE PLUG**

- Low Resistance for Maximum Signal Transfer
- Allows you to Connect One XLR Female Audio Input to Two XLR Male Outputs
- Molded Strain Relief for Ultimate Durability
- Gold-Plated Plug for Superior Sound Transfer



**ZP-YXLRFXLRMD-1**

**1FT Y-ADAPTER 3PIN XLR FEMALE TO DUAL 3 PIN XLR MALE**

- Allows you to Connect One XLR Female audio Input to Two XLR Male Outputs
- Molded Strain Relief for Ultimate Durability
- Heavy-Duty Metal Shell Connectors for a Reliable Connection



**ZP-YXLRFXLRMD-3**

**3FT Y-ADAPTER 3PIN XLR FEMALE TO DUAL 3 PIN XLR MALE**

- Allows you to Connect One XLR Female Audio Input to Two XLR Male Outputs
- Molded Strain Relief for Ultimate Durability
- Heavy-Duty Metal Shell Connectors for a Reliable Connection



**ZP-YXLRMXLRFD-1**

**1FT Y-ADAPTER 3PIN XLR MALE TO DUAL 3 PIN XLR FEMALE PRO AUDIO CABLE**

- Allows you to Split One XLR Male to Two XLR Females
- Molded Strain Relief for Ultimate Durability
- Heavy-Duty Metal Shell Connectors for a Reliable Connection



**ZP-YXLRMXLRFD-3**

**3FT Y-ADAPTER 3PIN XLR MALE TO DUAL 3 PIN XLR FEMALE PRO AUDIO CABLE**

- Allows you to Split One XLR Male to Two XLR Females
- Molded Strain Relief for Ultimate Durability
- Heavy-Duty Metal Shell Connectors for a Reliable Connection



**ZPC-24XF14M-25**

**25FT 3PIN XLR FEMALE TO 1/4" MALE PLUG**

- 24 Gauge Microphone Cable with Nickel Connector
- Extremely Low Capacitance for Pure Signal Transparency
- Molded Strain Relief for Ultimate Durability
- Durable yet Flexible, Black PVC Outer Jacket

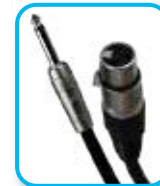



**ZPC-DXM35-10**

DUAL XLR MALE TO 3.5 MALE STEREO

- 10FT Pro Audio Cable
- Durable yet Flexible, Black PVC Outer Jacket
- Oxygen-Free Cable



**ZPC-XM35-10**

XLR MALE TO 3.5 STEREO RIGHT ANGLE PLUG

- 10FT Microphone Cable
- Durable yet Flexible, Black PVC Outer Jacket

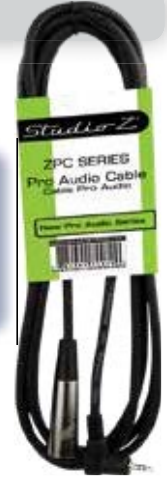

**ZPC-Y35S14DMN-6**

"Y" CABLE 3.5MM STEREO TO DUAL 1/4" MONO

- 6FT Pro Audio Cable
- Durable yet Flexible, Black PVC Outer Jacket



**ZDMX-3XLRMF-12B**

3 PIN XLR MALE TO XLR FEMALE DMX CABLE

- 12"
- Premium Jacket Materials Provide Ease of Handling and Long Service Life
- Bright Nickel-Plated Connectors for Long Term Good Looks and Conductivity
- 24 AWG Oxygen-free Copper Stranded Conductors for Maximum Signal Transfer



**ZDMX-3XLRMF-20B**

3 PIN XLR MALE TO XLR FEMALE DMX CABLE

- 20"
- Premium Jacket Materials Provide Ease of Handling and Long Service Life
- Bright Nickel-Plated Connectors for Long Term Good Looks and Conductivity
- 24 AWG Oxygen-Free Copper Stranded Conductors for Maximum Signal Transfer



**ZDMX-3XLRMF-30B**

3 PIN XLR MALE TO XLR FEMALE DMX CABLE

- 30"
- Premium Jacket Materials Provide Ease of Handling and Long Service Life
- Bright Nickel-Plated Connectors for Long Term Good Looks and Conductivity
- 24 AWG Oxygen-Free Copper Stranded Conductors for Maximum Signal Transfer



**ZDMX-5XLRMF-12B**

5 PIN XLR MALE TO XLR FEMALE DMX CABLE

- 12"
- Premium Jacket Materials Provide Ease of Handling and Long Service Life
- Bright Nickel-Plated Connectors for Long Term Good Looks and Conductivity
- 24 AWG Oxygen-Free Copper Stranded Conductors for Maximum Signal Transfer



**ZDMX-5XLRMF-20B**

5 PIN XLR MALE TO XLR FEMALE DMX CABLE

- 20"
- Premium Jacket Materials Provide Ease of Handling and Long Service Life
- Bright Nickel-Plated Connectors for Long Term Good Looks and Conductivity
- 24 AWG Oxygen-Free Copper Stranded Conductors for Maximum Signal Transfer



**ZDMX-5XLRMF-30B**

5 PIN XLR MALE TO XLR FEMALE DMX CABLE

- 30"
- Premium Jacket Materials Provide Ease of Handling and Long Service Life
- Bright Nickel-Plated Connectors for Long Term Good Looks and Conductivity
- 24 AWG Oxygen-Free Copper Stranded Conductors for Maximum Signal Transfer



**ZMC-24MXF-75BP**

3 PIN XLR MALE TO XLR FEMALE

- 75' Microphone Cable



**75 Ft**

**ZP-XLRM-35FB**

XLR MALE TO 3.5MM SOCKET

- XLR Male to 3.5mm Socket Adapter



**PKT-523WB**

**AM/FM/WB 3 BANDS RECEIVER**

- Frequency range:  
FM: 87-108 Mhz  
AM: 507-1710 Khz  
WB: 162.4-162.55
- Sensitivity:  
FM ≤ 30dB  
AM ≤ 70dB  
WB ≤ 20dB
- Signal-to-Noise Ratio:  
FM ≥ 50dB  
AM ≥ 0dB
- Earphone Jack: Ø 3.5mm Earphone Jack
- Power Supply: DC 3.0V
- Batteries: AA x2 (not included)
- Dimensions: 2.8" x 1.1" x 4.6" (72 x 28 x 118 mm)



**SDRV-KPII**

**REFLEX DRIVER**

- High Sensitivity Receiver
- External Earphone Jack
- 2AA Batteries (Battery Not Included)
- Unit Size: 111(H) x 63 (W) x 23(D)mm
- Frequency Range:  
AM 530-1600KHz  
FM 87-108MHz
- WB: NA
- Speaker: Ø40m/8Ω/0.5W
- Unit Weight: 95g
- Output Power: N/A



**PRT-742-WB**

**AM/FM/WB 3 BAND RECEIVER  
HIGH SENSITIVITY RECEIVER**

- Excellent Sound Performance
- Speaker: 3 Inch 4Ω 3W 45 Head
- External Earphone Jack
- DC 3V (UM-1 X 2)
- AC 220V/50Hz Input
- Output Power: 8W
- WB 400-550MHz
- Frequency Range: AM 530-1600KHz / FM 87-108MHz
- 2D Size Battery (DC 3V) (Battery Not Included)
- Unit Size: 190(W) x 110(H) x 50(D)



Studio Z

**BAND RECEIVERS/ REFLEX DRIVERS/ REPLACEMENT KAPTON VOICE COIL**

**AP-PRT-B1**

**PORTABLE RADIO WITH WIRELESS MUSIC STREAM**

- Supports MP3, WMA, USB AUX, FM Radio
- Number of speakers: 2
- Speaker size: 2x3"
- Frequency Range: 50Hz - 20KHz
- Signal to Noise Ratio: 75 dB
- Impedance: 4 Ohm
- Battery Type: 18650 Li-ion
- Battery Capacity: 3600mAh
- Battery Voltage: 3.7V
- Battery Duration: about 6 hrs on 75% volume
- Charging Time: about 4 hours
- Power Plug Type: USB Cable
- Charging Port: 5V DC
- Wireless Music Stream Range: > 10 Meters
- Weight: 2.78 Lbs
- Dimensions (LxWxH): 10.4" x 4.1" x 7.1"



**PRT-943-WBB**

**WIRELESS MUSIC STREAM**

- Frequency range:  
FM: 87-108 Mhz  
AM: 507-1710 Khz  
WB: 162.4-162.55
- Sensitivity:  
FM ≤ 20dB  
AM ≤ 80dB  
WB ≤ 20dB
- Signal-to-Noise Ratio: ≥ 40dB
- Earphone Jack: Ø 3.5mm Earphone Jack
- Power Supply: AC: 110V/220V, 60/50Hz / DC: 4.5V (UM-1) x3 (batteries not included)
- Dimensions: 9.1" x 2.4" x 5" (230 x 61 x 128 mm)



**SDRV-KPII**

**REFLEX DRIVER**

- Maximum Input Power: 100W
- Sound Pressure: 102dB±2dB
- Impedance: 8 Ohms
- Frequency Range: 2KHz - 20KHz
- Voice Coil: 1" KSV
- Magnet: 8.5 Oz.
- Common Replacement for JBL Driver



**SRDP-KP11**

**REPLACEMENT KAPTON VOICE COIL FOR SDRV-KP11**

- 1" Resin Film Super Diaphragm
- 1" High Temperature Kapton Voice Coil
- Single Pack in Gift Box



**SRDP-R15**

**REPLACEMENT KAPTON VOICE COIL FOR SDRV-R15**

- 1.3" Resin Film Super Diaphragm
- 1.3" High Temperature Kapton Voice Coil
- Single Pack in Gift Box



**SRDP-R23**

**REPLACEMENT KAPTON VOICE COIL FOR SDRV-R23**

- 1.7" Resin Film Super Diaphragm
- 1.7" High Temperature Kapton Voice Coil
- Single Pack in Gift Box



**NSCE-620**

**6" WOOFER  
W/ 1" ALUMINUM VOICE COIL**

- 6" Paper Cone with Cloth Edge
- Frequency Response: 70-10000 Hz
- Magnet Weight: 20 Oz
- Sensitivity: 86 dB
- Voice Coil Size: 1" ASV
- Max Power: 250 W
- Impedance: 8 Ohm



**6"**

**Sold Individually**

**NSCE-830**

**8" WOOFER  
W/ 1" ALUMINUM VOICE COIL**

- 8" Paper Cone with Cloth Edge
- Frequency Response: 50-5000 Hz
- Magnet Weight: 30 Oz
- Sensitivity: 89 dB
- Voice Coil Size: 1" ASV
- Max Power: 350 W
- Impedance: 8 Ohm



**8"**

**Sold Individually**

**NSCE-1040**

**10" WOOFER  
W/ 2" ALUMINUM VOICE COIL**

- 10" Paper Cone with Cloth Edge
- Frequency Response: 50-4500 Hz
- Magnet Weight: 40 Oz
- Sensitivity: 88 dB
- Voice Coil Size: 2" ASV
- Max Power: 425 W
- Impedance: 8 Ohm



**10"**

**Sold Individually**

**NSCE-1250**

**12" WOOFER  
W/ 2" ALUMINUM VOICE COIL**

- 12" Paper Cone with Cloth Edge
- Frequency Response: 35-5000 Hz
- Magnet Weight: 50 Oz
- Sensitivity: 92 dB
- Voice Coil Size: 2" ASV
- Max Power: 500 W
- Impedance: 8 Ohm



**12"**

**Sold Individually**

**NSCE-1550**

**15" WOOFER  
W/ 2" ALUMINUM VOICE COIL**

- 15" Paper Cone with Cloth Edge
- Frequency Response: 30-3700 Hz
- Magnet Weight: 50 Oz
- Sensitivity: 92 dB
- Voice Coil Size: 2" ASV
- Max Power: 675 W
- Impedance: 8 Ohm



**15"**

**Sold Individually**

Studio Z

PROFESSIONAL ABS LOUDSPEAKERS

SZC-1207BW

PROFESSIONAL ABS PA LOUD

- Woofer: 12"
- Voice Coil: 1.5"
- Magnet: 20 Oz
- Tweeter: 2.5" Titanium Driver
- Max. Power: 2500 Watts
- Voltage: 115/230V
- 12V 4.0Ah Rechargeable Battery Included
- Impedance: 4 Ohms
- Sensitivity: 94dB
- Frequency Response: 70Hz~20KHz
- LED Screen
  - + Memory Stick Host
  - + Wireless Music Stream
  - + Remote Control
- Line Input: RCA/AUX
- Wheels and handle for easy transportation

LED LIGHTING  
2500 WATTS



SZC-1507BW

PROFESSIONAL ABS LOUDSPEAKER

- Woofer: 15"
- Voice Coil: 1.5"
- Magnet: 20 Oz
- Tweeter: 2.5" Titanium Driver
- Maximum Power: 3000 Watts
- Voltage: 115/230V
- 12V 4.5Ah Rechargeable Battery Included
- Impedance: 4 Ohms
- Sensitivity: 95dB
- Frequency Response: 60Hz~20KHz
- LED Screen
  - +Memory Stick Host
  - +Wireless Music Stream
  - +Remote Control
- Line Input: RCA/AUX
- Wheels and Handle for Easy Transportation

LED LIGHTING  
3000 WATTS  
15" WOOFER



WIRELESS MIC INCLUDED



ZMX-3000

3 PIECE HOME AUDIO SYSTEM

- Power Input: 110V-240V AC, 50/60Hz
- Power: 30W + 12W x 2
- Frequency: 40Hz-18Hz
- Sensitivity: ≥ 65dB
- 2.1 Multimedia Speaker System
- 6.5" Subwoofer + 3" Speaker x 2
- With Wireless Music Stream/USB/MMC/FM
- Remote control included
- HIFI sound quality



**SPA-1000BT**

**DIGITAL KARAOKE STEREO AMPLIFIER**

- 15 Watts x 2, 8 Ohm / 20 Watts x 2, 4 Ohms
- Wireless Music Stream Ability
- USB/SD/MMC Card Reader Function with Display
- Remote Control for USB/SD/MMC Inputs
- FM Radio Function
- 2 Mic Input Jacks
- Master Channel Volume/Bass/Treble/Balance Control
- Mic Channel Volume/Echo Control
- 110V-220V Switchable
- Dimensions: 10.2" x 8.3" x 3.1" (260 x 210 x 80 mm)
- Weight: 2.3Kg (5.1Lbs)



**SPA-1200BT**

**HYBRID DIGITAL RECEIVER AMPLIFIER**

- 60W x 2, 8 Ohm/ 100W x 2, 4 Ohm
- Master Channel Volume/Bass/Treble/Balance Control
- 2 MIC Input with Volume/Bass/Treble/Echo Control
- Digital AM/FM Tuner with Scan and Auto Store Function
- 30 AM and 30 FM Stations Storage
- USB Reader Function with Play/Pause/Prev Next Control
- MP3 Input Jack with Cable
- A/B Speaker Output
- AUX/Record Output
- 110V/220V Switchable
- Dimensions: 16.9" 12.2" x 4.7"
- Weight: 11.2 Lbs



Perfect for Karaoke and Commercial Entertainment System

**SPA-2000BT**

**HYBRID DIGITAL RECEIVER AMPLIFIER**

- 75W x 2, 8 Ohm / 90W x 2, 4 Ohm
- AM/FM Quartz Synthesized Tuner
- Auto Station Seek
- IPOD/MP3 Input With Cable (3.5mm to 3.5mm Cable, Black)
- USB Reader Function
- Inputs: RCA (2 Audio Sources)
- Outputs: Banana Binding Post
- 1 RCA Dedicated for Record Line Output
- 2 Mono RCA Dedicated for Subwoofer Output
- 1 RCA Dedicated for Preamp Output
- Separate Gain Control for Preamp and Subwoofer
- Digital Fluorescent Output Display Meter
- Removable Rack-Mount Brackets
- Dimensions: 19"(W) x 3.5" (H) x 13.2"(D)
- Weight: 15.9 LBS
- 110-220 Switchable



### SPA-3070BPA

#### DIGITAL RECEIVER P.A. AMPLIFIER

- 100 Watts x 2, 8 Ohm / 130 Watts x 2, 4 Ohm.
- 8 Ohm and 70V/100V output terminals for PA speakers.
- 1 RCA dedicated for record line output.
- 2 Mono RCA dedicated for subwoofer output.
- Separate gain control for preamp and subwoofer output.
- AUX MP3 input.
- USB reader function.
- Wireless music stream ability.
- Removable rack-mount brackets.
- AM/FM quartz synthesized tuner.
- Auto station scan and store.
- 60 radio station storage.
- Full function remote control.
- 110V-220V switchable.
- Dimensions (W x H x D):  
19" x 3.5" x 13.2"  
(483 x 89 x 335 mm).
- Weight: 7.7Kg (17Lbs).



### SPA-3000BT

#### HYBRID DIGITAL RECEIVER AMPLIFIER

- 100W x 2, 8 Ohm / 130W x 2, 4 Ohm
- AM/FM Quartz Synthesized Tuner
- Auto Station Seek and Store ( 60 Radio Station Storage)
- Full Function Remote Control
- IPOD/MP3 Input With Cable (3.5mm to 3.5mm Cable, White)
- USB Reader Function
- Inputs: RCA (2 Audio Sources)
- Outputs: Banana Binding Post Hybrid digital Receiver Amplifier
- 1 RCA Dedicated for Record Line Output
- 2 Mono RCA Dedicated for Subwoofer Output
- 1 RCA Dedicated for Preamp Output
- Separate Gain Control for Preamp and Subwoofer
- Digital Fluorescent Output Display Meter
- Removable Rack-Mount Brackets
- Dimensions: 19"(W) x 3.5" (H) x 13.2"(D)
- Weight: 16.8 LBS
- 110-220 Switchable



### HD-ATSC-4RM

#### REPLACEMENT TV REMOTE

- Replace Remote Control for (HD-ATSC-4 Digital TV Converter)





**SPA-5000BT**

**HYBRID DIGITAL RECEIVER AMPLIFIER**

- 180W x 2, 8 Ohm / 250W x 2, 4 Ohm
- AM/FM Quartz Synthesized Tuner
- Auto Station Seek and Store ( 60 Radio Station Storage)
- Full Function Remote Control
- IPOD/MP3 Input With Cable (3.5mm to 3.5mm Cable, Black)
- USB Reader Function
- Inputs: RCA (2 Audio Sources)
- Outputs: Banana Binding Post
- 1 RCA Dedicated for Record Line Output
- 2 Mono RCA Dedicated for Subwoofer Output
- 1 RCA Dedicated for Preamp Output
- Separate Gain Control for Preamp and Subwoofer
- Digital Fluorescent Output Display Meter
- Removable Rack-Mount Brackets
- Dimensions: 19"(W) x 3.5" (H) x 15.9"(D)
- Weight: 23.3 LBS
- 110-220 Switchable



**STNR-100**

**AM/FM PLL TUNER / CLOCK WITH BUILT IN ALARM**

- 60 (AM + FM) Radio Station Storage
- Tuning/ Pre/ Next/ Auto Scan/ Store and
- I-10+ Select Keys for Tuner
- Rack Mount Brackets
- 110-220V Switchable
- Clock Display (AM-PM) can Start or Off at Set Time
- Remote Control
- Dimensions: 19"(W) x 9.4"(H) x 1.6"(D)
- Weight: 3.5 lbs



StudioZ

STEREO SPEAKER SELECTORS

SPA-1050CMB

MINI COMPONENT HOME SPEAKER SYSTEM

- 15 Watts x 2, 8 Ohm / 20 Watts x 2, 4 Ohm
- Wireless music stream ability
- USB/SD/MMC card reader function with display
- FM radio function
- 2 Mic input jacks
- 110V-220V switchable
- Dimensions: 10.2" x 8.3" x 3.1" (260 x 210 x 80 mm)
- Weight: 2.3Kg (5.1lbs)
- Woofer size: 5"
- Magnet size: 80 Oz
- Impedance: 4 Ohms
- Tweeter size: 3"

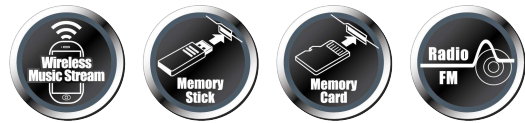

SPA-140SEL

4-WAY DUAL-SOURCE, IMPEDANCE-MATCHING SPEAKER SELECTOR WITH ZONE VOLUME CONTROLS

- 900W Total Music Power
- 300W Total RMS Continuous Power Handling
- Heavy Duty Transformer Based Impedance Matching System Protects against Power Loss
- Left and Right Channels are Completely Isolated for Safe Operation with any Amplifier, even Bridged Amplifiers
- Quick Connect Terminals will Accommodate 16 to 22Ga Wire
- Can be Connected to Two Separate Amplifiers via A/B Switch
- Circuit Breaker Protected



SPA-160SEL

6-WAY DUAL-SOURCE, IMPEDANCE-MATCHING SPEAKER SELECTOR WITH ZONE VOLUME CONTROLS

- 900W Total Music Power
- 300W Total RMS Continuous Power Handling
- Heavy Duty Transformer Based Impedance Matching System Protects against Power Loss
- Left and Right Channels are Completely Isolated for Safe Operation with any Amplifier, even Bridged Amplifiers
- Quick Connect Terminals will Accommodate 16 to 22Ga Wire
- Can be Connected to Two Separate Amplifiers via A/B Switch
- Circuit Breaker Protected



**SZ-6200U**

**6 CHANNEL 600W POWERED MIXER W/MP3 & USB INPUT**

- 6 Balanced Microphone Inputs Phantom Power
- 6 x ¼" Line/High Impedance/Balanced Input
- Master Output: 600 Watts RMS 4 Ohms
- With USB 2.0 Terminal and LCD
- 5-Band Graphic Equalizer
- Effect Channel Control
- Tape Input, Rec Output
- Channel Tone Adjust (High/Low+/-15dB)
- AUX/TAPE/Effect Feedback Input
- Master Volume Control
- Phantom +15v
- AC 110/220v Selectable
- Dimensions: 17.32" x 12.01" x 7.87"



**SZ-8200U**

**8 CHANNEL 800W POWERED MIXER W/MP3 & USB INPUT**

- 8 Balanced Microphone Inputs Phantom Power
- 8 x ¼" Line/High Impedance/Balanced Input
- Master Output: 800 Watts RMS 4 Ohms
- With USB 2.0 Terminal and LCD
- 5-Band Graphic Equalizer
- Effect Channel Control
- Tape Input, Rec Output
- Channel Tone Adjust (High/Low+/-15dB)
- AUX/TAPE/Effect Feedback Input
- Master Volume Control
- Phantom +15v
- AC 110/220v Selectable
- Dimensions: 20.28" x 12.01" x 7.87"



Studio Z®

**PASSIVE DIRECT BOXES/  
PORTABLE SPEAKERS**

**DB-01**

**PROFESSIONAL SINGLE-CHANNEL PASSIVE DIRECT BOX**

- Input Attenuation: Switchable (0dB, -20dB, -40dB)
- Instrument Input: 50K Unbalanced TS Jack
- Parallel (Link) Out: 50K Unbalanced TS Jack
- Balanced Output: 600Ω Balanced XLR Jack
- Ground Lift: Switchable Ground lift
- Construction: All Steel Chassis
- Dimensions: 4.7" x 3" x 1.8" (120 x 76.5 x 45mm)



This box lets you connect an unbalanced, high impedance signal to a balanced, low-impedance input. It is most often used for plugging a keyboard, electric guitar, or electric bass guitar directly into a mixing console's microphone - level input. It can also be used in DJ applications.

**DB-02**

**PROFESSIONAL DUAL-CHANNEL PASSIVE DIRECT BOX**

- Input Attenuation: Switchable (0dB, -20dB, -40dB)
- Instrument Input: 50K Unbalanced TS Jack
- Parallel (Link) Out: 50K Unbalanced TS Jack
- Balanced Output: 600Ω Balanced XLR Jack
- Ground Lift: Switchable Ground Lift
- Construction: All Steel Chassis
- Dimensions: 5.3" x 3.7" x 1.6" (134 x 95 x 40mm)



This box lets you connect an unbalanced, high impedance signal to a balanced, low-impedance input. It is most often used for plugging a keyboard, electric guitar, or electric bass guitar directly into a mixing console's microphone - level input. It can also be used in DJ applications.

**STZP-400**

**4" PORTABLE WIRELESS SPEAKER**

- Frequency: 100Hz - 18kHz
- Input Sensitivity: 550±50MV
- Charging Voltage: 5V/500MA
- Wireless Connection Distance: ≤ 10 Meters
- Battery: 3.7V ,1200mAh
- Wireless Version: Jely 2.1+1
- S/N Ratio: ≥ 75DB
- Distortion: 10%
- Drive Unit: 1 x 4"
- Supported Functions: Wireless MusicStream, USB Drive, TF Card Play, FM, LINE
- Working Time: 3 - 4 Hours



Battery is easily replaceable



**STZP-525**

**5.25" PORTABLE WIRELESS SPEAKER**

- Frequency: 100Hz - 18kHz
- Input Sensitivity: 6003100MV
- Charging Voltage: 5V/500MA
- Wireless Connection Distance: 8-12 Meters
- Battery: 3.7V ,1200mAh
- Wireless Version: Jely 2.1+1
- S/N Ratio: ≥ 60DB
- Distortion: 10%
- Drive Unit: 1 x 5.25"
- Supported Functions: Wireless Music Stream, USB Drive, TF Card Play, FM, LINE
- Working Time: 2.5 - 4 Hours



**STZP-650**

**6.5" PORTABLE WIRELESS SPEAKER**

- Use: Computer, Home, Theatre, Karaoke Player, Mobile Phone, Portable Audio Player
- Function: Aux-in, / USB Drive / SD Card / FM / Wireless Music Stream Control / Microphone Player / Remote control
- Port: Line In / USB / TF Card / Mic In / USB 5V In / Microphone Port
- Includes Wired Microphone
- Volume Control Knob
- Mic Echo Volume Control Knob
- Dancing RGB LED Light
- Working Distance: <10 Meters in Open Space
- Frequency Range: 200Hz - 20KHz
- Driver Unit: 6.5" x 1"
- Battery: 18650/2 x 1500mAh
- S/N Ratio: ≥ 80dB
- Charging Voltage: DC 5V (Micro USB)
- Supported Audio Formats: MP3
- Charging Time: 1.5 - 2 Hours
- Play-Back Time: 3 - 4 Hours
- Dimensions: (W x H x D): 8.3" x 12.8" x 8.3"
- Net Weight: 3.75 Lbs



**STZP-800**

**8" RECHARGEABLE SPEAKER**

- 10" Woofer
- 1" Horn
- With USB / TF / FM / Wireless Music Stream
- AUX Input
- Microphone Input
- Controller Board on the Top
- LED Display Screen
- Remote Control Included
- (1) Wired Mic Included
- Impedance: 4 ohm
- Max Power: 1000W
- Weight: 3.4 Kg (7.5 Lbs)
- Dimensions: 11.2" x 10.2" x 18.5"
- Multicolor Changing LED Lit Woofer
- Built-In Battery: 3.7V / 2200mAh
- Frequency Response: 45Hz - 20kHz
- Sensitivity (1w / 1m): 92dB



**STZP-1000**

**10" RECHARGEABLE SPEAKER**

- 10" Woofer
- 1" Horn
- With USB / TF / FM / Wireless Music Stream
- AUX Input
- Microphone Input
- Controller Board on the Top
- LED Display Screen
- Remote Control Included
- (1) Wired Mic Included
- Impedance: 4 ohm
- Max Power: 1000W
- Weight: 3.4 Kg (7.5 Lbs)
- Dimensions: 11.2" x 10.2" x 18.5"
- Multicolor Changing LED Lit Woofer
- Built-In Battery: 3.7V / 2200mAh
- Frequency Response: 45Hz - 20kHz
- Sensitivity (1w / 1m): 92dB





MUSICAL EQUIPMENT  
*2022 CATALOG*



**MS-WB812**

**SPEAKER WALL BRACKET**

- Dimension: 11 cm
- Weight Capacity: 25 Kg
- Material: Sheet Iron
- Tilt Swivel Feature: Tilt
- Tilt: 20°
- Most 8", 10" and 12" DJ Cabinets

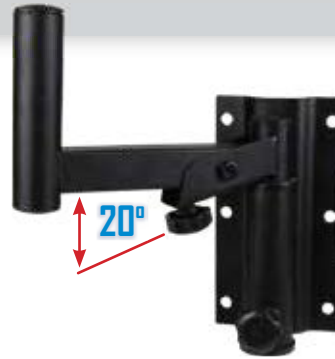

**MS-WB1215**

**SPEAKER WALL BRACKET**

- Dimension: 11 cm
- Weight Capacity: 25 Kg
- Material: Sheet Iron
- Tilt Swivel Feature: Tilt
- Tilt: 20°
- Most 12" and 15" DJ Cabinets

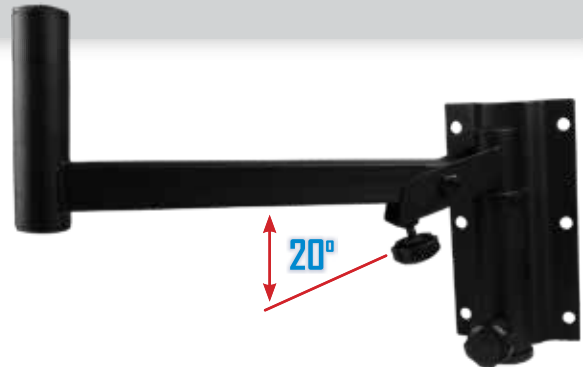

**MS-PE12**

**TUBE EXTENSION**

- Outer Tube (Diameter x Height): 41.7 mm x 820 mm
- Inner Tube (Diameter x Height): 35mm x 820 mm





MUSICAL EQUIPMENT

STANDS

**MSKB-91**

MIXER AND KEYBOARD STAND

- Adjustable Height: 20.9" - 37.8" (530-960 mm)
- Bottom Pipe: 18.1" (360 mm)
- Top Pipe: 14.2" (360 mm)
- Loading Capacity: 110 lbs (50 kg)
- Color: Black



**MAR-300**

PROFESSIONAL MIXER STAND

- For 18.9 x 16.9 inch (480 x 430 mm) DJ Mixer
- TILT: 45° DOWN
- Maximum DJ Mixer Weight: 60 kg (132 lbs)
- Product Parameter:  
H: 34.6 inch (880 mm)  
W: 17.6 lbs (8 kg)
- Slanting Pipe: 21.7~35.4 inch (550-900 mm)



**MAR-LT200**

LAPTOP BRACKET

- Black Spray-Painted Iron
- Height & Width Adjustable
- Fix with Screwed Clamp



Clamps for DJ Flight Case



Base for DJ Table



**MSKB-100**

**KEYBOARD STAND**

- Adjustable Height: 26.8" ~ 39.4"
- Bottom Pipe: 25.2", Top Pipe: 16.1"
- Weight: 4.5 kg



**MSKB-101**

**KEYBOARD STAND**

- Adjustable Height: 23.8" ~ 39" (605~990 mm)
- Bottom Pipe: 17.9" (455 mm)
- Top Pipe: 14" (355 mm)
- Loading Capacity: 88.2 lbs (40 kg)
- Weight: 7.1lbs (3.2 kg)



**MSKB-200**

**DOUBLE KEYBOARD STAND**

- Adjustable Height: 39.4" ~ 49.6"
- Bottom Pipe: 25.2", Top Pipe: 16.1"
- Weight: 5.8 kg





MUSICAL EQUIPMENT

STANDS

MS-9

PROFESSIONAL P. A. SPEAKER STAND

- Height Adjustment Grip
- Height: 2 5.6" - 48.0" (650 - 1220 mm)
- Weight: 4.9 Lbs (2.2 kg)
- Supports up to: 110 Lbs (50 kg)
- Tube Thickness: 0.8 mm



MS-11

PROFESSIONAL P. A. SPEAKER STAND

- Stand with P.A. Speaker Holder
- Height Adjustment Grip
- Height: 39.4" - 74.0" (1000 - 1880 mm)
- Weight: 8.4 Lbs (3.8 kg)
- Supports up to: 165 lbs (75 kg)
- Tube Thickness: 0.8 mm



MS-16LED

SPEAKER STAND WITH LED

- Height range: 39" ~ 71" (99 ~ 180cm)
- Folded length: 35.4" (90cm)
- Load capacity: 55lbs (25kg)
- Weight: 6.2lbs (2.8kg)
- Uses heavy-duty steel tubing
- Easy and fast height adjustments
- Cast-alloy tripod leg base to ensure maximum stability
- AC/DC: 100 ~ 240VAC 50/60Hz 12V 2A

Features:

- Perfectly fits socket below enclosure
- Adjustable heights
- All parts are replaceable
- Remote control with programs and options
- RGB Colors spectrum available



DS-201

PLASTIC BASE

- Plastic Base for P. A. Speaker Stands



DS-203

ALUMINUM BASE

- Aluminum Base for P. A. Speaker Stands



DS-205

IRON BASE

- Iron Base for P. A. Speaker Stands



DS-303

BASE

- Base for D-11





## MUSICAL EQUIPMENT

# STANDS

### F-8

#### BOOM FLOOR STAND

- Boom Floor Stand with Die Cast Base
- Black Finished



### F-13

#### LONG BOOM DESK STAND

- Long Boom Desk Stand Professional Series
- Black Finished



### MS-5

#### MICROPHONE STAND

- Microphone Stand with Boom Mic Holder and Height Adjustment
- Black Finished



### MS-5CHR

#### MICROPHONE STAND

- Adjusts Up to 6'
- Height: 31.5"~55.1"
- Weight: 3.1 lbs
- Slating Pipe: 29.5"
- Chrome Finish



### MS-6

#### MICROPHONE STAND

- Adjusts to Different Heights
- Height: 38.6"~66.1"
- Weight: 3.7 lbs
- Cross Pipe: 29.5"



### MS-13

#### MICROPHONE STAND

- Microphone Stand with Adjustable Angle and Height Adjustment
- Black Finished





MUSICAL EQUIPMENT

STANDS

MS-2

MICROPHONE STAND

- Stand with Microphone Holder
- Height Adjustment Grip
- Product Parameter:  
Height: 37.8" - 55.1"  
(661-1680 mm)  
Weight: 9.9 lbs (4.5 kg)
- Stage Microphone



MSQ-57

MICROPHONE STAND

- Adjusts up to 6'
- Parameter: H 41.3 - 66.1"  
W: 7.7 Lbs
- Slanting Pipe: 21.7 - 35.4"
- Includes 1 Microphone Clamp
- Microphone Stand with Boom Mic Holder and Quick Grip Height Adjustment



MSMS-51

MUSIC SHEET STAND FOLDABLE

- Height Adjustable, Foldable Legs, Lightweight, Metal Construction
- Two Section Design with Adjustable Angle Desk
- Stand Includes Wire Music Clips and Rubber Feet
- Stand Folds to 21-1/2 inches, Folding Tripod Design
- Height Adjustment to 36 inches

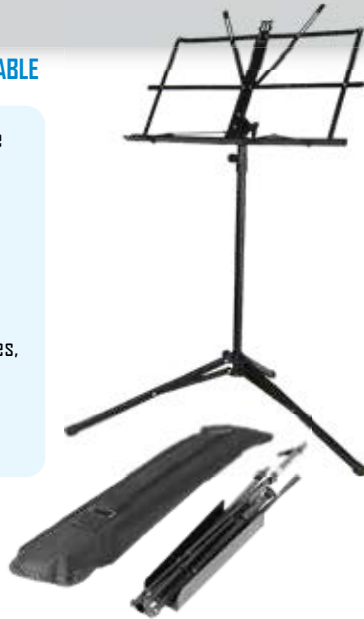

MSMS-52

FOLDABLE SHEET MUSIC STAND WITH CLIPS

- Height Adjustable, Foldable Legs, Lightweight, Metal Construction
- Two Section Design with Adjustable Angle Desk
- Stand Includes Wire Music Clips and Rubber Feet
- Stand Folds to 21-1/2 inches, Folding Tripod Design
- Height Adjustment



MS-ITBLT

MULTIMEDIA TABLET HOLDER FOR STANDS

- Fully Adjustable Multimedia Tablet Holder
- Pivot, Tilt, Rotate, Raise and Lower
- Pole Height: 18.5~32cm
- Accommodates Tablets from: 10.7cm to 20cm



Two Mounting OPTIONS



## MUSICAL EQUIPMENT

## STANDS

### MS-LS101

#### DJ STAND

- Universal Laptop Notebook Placement
- Rugged and Durable Metal Construction
- Convenient Sound Equipment Placement
- Quick and Easy Setup
- Lightweight, Portable and Reliable
- Tripod Floor Standing Design
- Quick and Convenient Height Adjustments
- Minimum Height: 26"
- Maximum Height: 44.1"
- Weight: 6.8 lbs
- Perfect for On-Stage or In-Studio Use
- Folds Completely for Travel and Storage
- Shelf/Plate Size: 16" x 20"
- Glossy Black Finish



Laptop  
No Included



Adjustable  
Stabilization



Adjustable  
Angle/Height

### F-915

#### BOOM FLOOR STAND PIG IRON DIECASTING

- Height: 35-62 cm
- ARM Length: 40 cm
- Weight: 1.62 Kg
- PIG Iron Diecasting: 14mm



### F-917

#### BOOM FLOOR STAND

- Height: 35-55 cm
- ARM Length: 40 cm
- Weight: 2.542 Kg
- Spray Plastic: Ø180mm



### F-3

#### DESK STAND

- Microphone Desk Stand



### F-4

#### DESK STAND

- Desk Stand with Die Cast Base

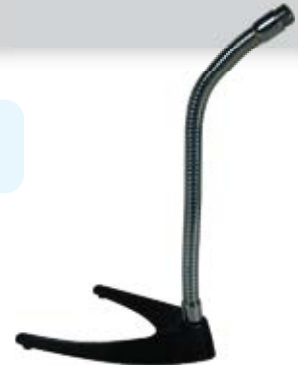

### F-6

#### DESK STAND

- Microphone Desk Stand

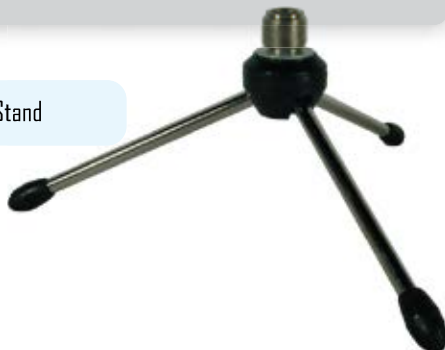

### MSG-22

#### A FRAME GUITAR STAND

- Height: 43 cm
- Width: 26 cm
- Weight: 1.30 kg
- Compatible with: Electric Guitars, Bass Guitars, Classic Guitars, Acoustic Guitars
- For Different Sizes: 33", 36", 39"

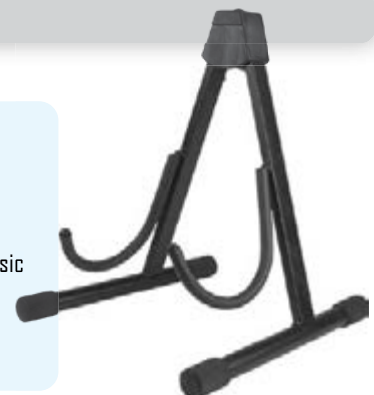



MUSICAL EQUIPMENT

HOLDERS

**A-1S BLK**

**EZ SLIP-IN CLAMP**

- Single Microphone Holder
- Malleable to Fit Most Standard and Oversized Microphones
- Black Color



**A-1S WHT**

**EZ SLIP-IN CLAMP**

- Single Microphone Holder
- Malleable to Fit Most Standard and Oversized Microphones
- White Color



**A-2**

**SINGLE MICROPHONE HOLDER**

- Spring Type Holder
- Black Color



**A-3**

**SINGLE MICROPHONE HOLDER**

- Spring Type Holder
- Black Color



**A-52**

**2 MIC HOLDER**

- Break Resistant
- Fits Standard Microphone Stands
- For 1" and Large Handles
- Black Color



**A-54**

**4 MIC HOLDER**

- Break Resistant
- Fits Standard Microphone Stands
- For 1" and Large Handles
- Black Color





MUSICAL EQUIPMENT

HOLDERS / ACCESSORIES

A-5

MICROPHONE CLIP HOLDER MIC STAND ACCESSORY

- Small Size



A-6

MICROPHONE CLIP HOLDER MIC STAND ACCESSORY

- Large Size



A-10

SLIDE TYPE HOLDER

- Copper Screw



D-8 (13")

D-8-19 (19")

GOOSENECK BASE

- Metal

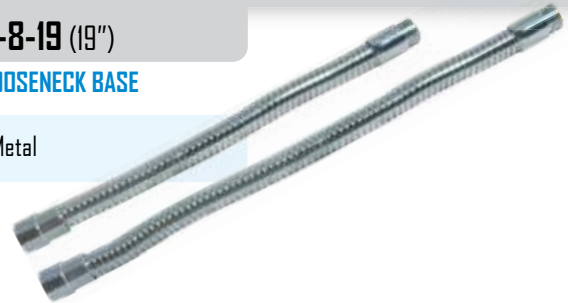

D-14

MALE GOOSENECK BASE

- Metal



D-15

FEMALE GOOSENECK BASE

- Metal



F-7M

???

- ????



F-SCREW

ON-STAGE STAND MIC SCREW ADAPTOR

- 5/8 Male to 3/8 Female Screw Adapter for Use with Mic Stands that have European 3/8" Threads
- Sold Individually





MUSICAL EQUIPMENT

MACHINE HEADS

**ADD-017A (W)**

GUITAR REPLACEMENT  
TUNING KEYS

- Nickel-Plated Tuning Keys (Short)
- Steel Pegs



**ADD-018C (W)**

GUITAR REPLACEMENT  
TUNING KEYS

- Nickel-Plated Tuning Keys (Long)
- Plastic Pegs



**ADD-019C (W)**

GUITAR REPLACEMENT  
TUNING KEYS

- Gold-Plated Tuning Keys (Long)
- Plastic Pegs



**ADD-017AP**

GUITAR ACCESSORIES

- Machine Head

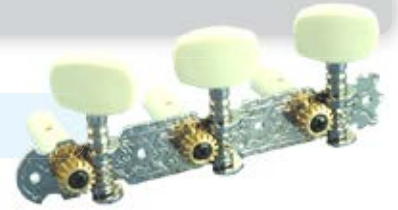

**ADD-018CP**

GUITAR ACCESSORIES

- Nickel 3 Machine Head (Long)



**ADD-019CP**

GUITAR ACCESSORIES

- Gold 3 Machine Head (Long)

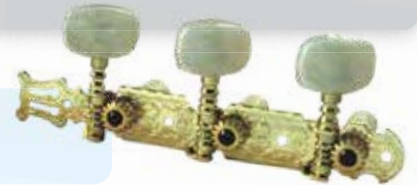

**AS-016P**

LOCKED MACHINE HEAD

- Single Chrome-Plated Locked Machine Head



**AOS-020B1P**

MACHINE HEAD

- Gold Plated 3 Machine Head (Short)





**A007A/BK**

**GUITAR CAPO**

- Acoustic



**A007B**

**CLASSIC GUITAR CAPO**

- Metal Finish

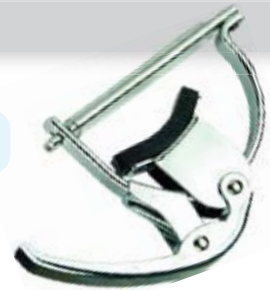

**A007C/BK**

**GUITAR CAPO**

- Classical



**A007D/SL-A**

**ACOUSTIC GUITAR CAPO**

- With Polished Finish



**A007D/BK-C**

**GUITAR CAPO**

- Classical Guitars



**A007D/SL-C**

**CLASSIC GUITAR CAPO**

- With Polished Finish



**A 106-H-1**

**A 106-H-5**

**A 106-H-6**

**CLASSICAL GUITAR STRING**

- Plastic Bag

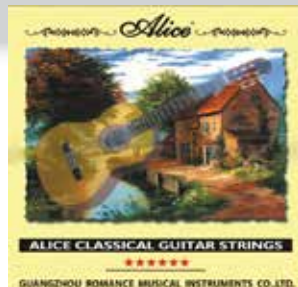

**AC136BK-N**

**CLASSIC GUITAR STRING**

- Black Nylon
- Nylon Core
- Coated Copper Wound
- Proprietary Anti-Rust Coat



KIT		Inch	mm
A 106-H-1	Clear Nylon	.0285	0.72
A 106-H-5	Silver-Plated Copper Wound	.036	0.91
A 106-H-6	Silver-Plated Copper Wound	.044	1.12

AC136BK-N KIT		Inch	mm
Black Nylon		.028	0.71
Black Nylon		.032	0.81
Coated Copper Alloy Wound		.025	0.63
Coated Copper Alloy Wound		.029	0.74
Coated Copper Alloy Wound		.035	0.89
Coated Copper Alloy Wound		.043	1.09



MUSICAL EQUIPMENT

**GUITAR STRINGS**

**A 107BK-H**

**GUITAR STRING**



**A 107BK-H KIT**

		Inch	mm
E-1st	Black Nylon	.0285	0.72
B-2nd	Black Nylon	.0325	0.83
G-3rd	Black Nylon	.041	1.04
D-4th	Gold-Plated Copper Alloy Wound	.030	0.76
A-5th	Gold-Plated Copper Alloy Wound	.036	0.91
E-6th	Gold-Plated Copper Alloy Wound	.044	1.12

**AC107-N**

**CLASSICAL GUITAR STRING**

- Clear Nylon
- Silver-Plated Copper Alloy Winding

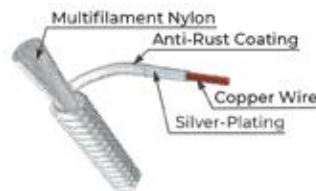

	E-1st	B-2nd	G-3rd	D-4th	A-5th	E-6th	
N (Normal Tension)	.028	.032	.040	.029	0.35	.043	inch
	0.71	0.81	1.02	0.74	0.89	1.09	mm
H (Hard Tension)	.0285	.0325	.041	.030	0.36	.044	inch
	0.72	0.83	1.04	0.76	0.91	1.12	mm

**A2012**

**ACOUSTIC FOLK  
GUITAR STRINGS**

- Acoustic Guitar Stainless Steel
- Steel Core
- Coated Copper Alloy



**A2012 KIT**

	Inch	mm
Stainless Steel	.010	0.25
Stainless Steel	.010	0.25
Stainless Steel	.014	0.36
Stainless Steel	.014	0.36
Coated Copper Alloy Wound	.022	0.56
Stainless Steel	.008	0.20
Coated Copper Alloy Wound	.030	0.76
Stainless Steel	.012	0.30
Coated Copper Alloy Wound	.040	1.02
Stainless Steel	.018	0.46
Coated Copper Alloy Wound	.050	1.27
Coated Copper Alloy Wound	.026	0.66

**A306-SL**

- A306-SL-1
- A306-SL-2
- A306-SL-3
- A306-SL-4
- A306-SL-5
- A306-SL-6



**ACOUSTIC GUITAR STRINGS**

- Acoustic Guitar, Stainless Steel, Silver Plated, Copper Wound, Extra-Light Strings

**A306-SL KIT**

		Inch	mm
E-1st	Stainless Steel	.011	0.25
B-2nd	Stainless Steel	.015	0.38
G-3rd	Silver-Plated Copper Wound	.024	0.61
D-4th	Silver-Plated Copper Wound	.032	0.81
A-5th	Silver-Plated Copper Wound	.042	1.07
E-6th	Silver-Plated Copper Wound	.052	1.32



MUSICAL EQUIPMENT

GUITAR STRINGS

A307-SL  
A307-SL-1  
A307-SL-2  
A307-SL-4  
A307-SL-5  
A307-SL-6



ACOUSTIC GUITAR STRINGS

- Stainless steel. Steel Core. Nickel-Plated Ball-End. Silver-Plated Copper Alloy Winding. Super Light.

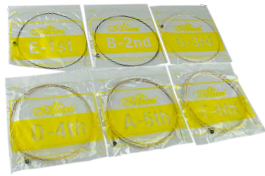

A306-SL KIT

		Inch	mm
E-1st	Stainless Steel	.011	0.25
B-2nd	Stainless Steel	.015	0.38
G-3rd	Silver-Plated Copper Alloy Wound	.024	0.61
D-4th	Silver-Plated Copper Alloy Wound	.032	0.81
A-5th	Silver-Plated Copper Alloy Wound	.042	1.07
E-6th	Silver-Plated Copper Alloy Wound	.052	1.32

A308-SL  
A308-SL-1  
A308-SL-2



ACOUSTIC GUITAR STRINGS

- Acoustic Guitar, Stainless Steel, Silver Plated, Copper Wound, Extra-Light Strings



A308-SL Super Light

Note	Inch	mm
E	.011	0.28
B	.015	0.38
G	.024	0.61
D	.032	0.81
A	.042	1.07
E	.052	1.32

A406-L

ACOUSTIC GUITAR STRINGS

- Acoustic Guitar, Stainless Steel, Bronze Wound, Light Strings



A406-L KIT

	Inch	mm
Stainless Steel	.012	0.30
Stainless Steel	.016	0.41
Coated Copper Alloy Wound	.024	0.61
Coated Copper Alloy Wound	.032	0.81
Coated Copper Alloy Wound	.042	1.07
Coated Copper Alloy Wound	.053	1.35

A407C-SL

ACOUSTIC GUITAR STRINGS

- Colorful strings for Acoustic Guitar
- Stainless Steel
- Steel Core
- Colorful Coated Copper Alloy Winding



Note	Inch	mm
E-1st	.011	0.28
B-2nd	.015	0.38
G-3rd	.024	0.61
D-4th	.032	0.81
A-5th	.042	1.07
E-6th	.052	1.32

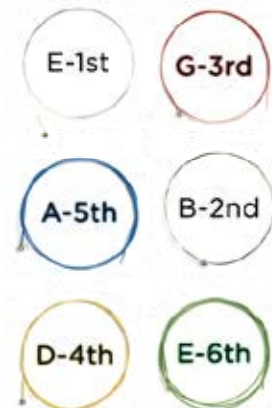



MUSICAL EQUIPMENT

**GUITAR STRINGS**

- A 506-SL
- A 506-SL-1
- A 506-SL-2
- A 506-SL-3
- A 506-SL-4
- A 506-SL-5
- A 506-SL-6



**ELECTRIC GUITAR STRING**

- Electric Guitar, Stainless Steel, Nickel Round Wound, Extra-Light Strings

A506-SL KIT		Inch	mm
A 506-SL-1	Plated Steel	.009	0.23
A 506-SL-2	Plated Steel	.011	0.28
A 506-SL-3	Plated Steel	.016	0.41
A 506-SL-4	Nickel Alloy Wound	.024	0.61
A 506-SL-5	Nickel Alloy Wound	.032	0.81
A 506-SL-6	Nickel Alloy Wound	.042	1.07

- A 507-SL
- A 507-SL-1
- A 507-SL-2
- A 507-SL-3
- A 507-SL-4
- A 507-SL-5
- A 507-SL-6

CHECK THIS ????



**ELECTRIC GUITAR STRING**

- Electric Guitar, Plated Steel, Nickel Alloy Wound, Nickel-Plated Ball-End, Plastic Bag

A507-SL KIT		Inch	mm
E-1st	Plated Steel	.009	0.23
B-2nd	Plated Steel	.011	0.28
G-3rd	Plated Steel	.016	0.41
D-4th	Nickel Alloy Wound	.024	0.61
A-5th	Nickel Alloy Wound	.032	0.81
E-6th	Nickel Alloy Wound	.042	1.07

**AE530-SL**

**ELECTRIC GUITAR STRING**

- Plated Steel
- Hexagonal Core
- Nickel Alloy Wound



AE530-SL		
Note	Inch	mm
E-1st	.009	0.23
B-2nd	.011	0.28
G-3rd	.016	0.41
D-4th	.024	0.61
A-5th	.032	0.81
E-6th	.042	1.07

- A606(4)-M-1
- A606(4)-M-2
- A606(4)-M-3
- A606(4)-M-4
- A606(5)-M
- A606(6)-M



**ELECTRIC BASS STRING**

- Acoustic Guitar, Stainless Steel, Silver Plated, Cooper Wound, Extra-Light Strings

A606-M KIT		
	Inch	mm
Nickel Alloy Wound	.032	0.81
Nickel Alloy Wound	.045	1.14
Nickel Alloy Wound	.065	1.65
Nickel Alloy Wound	.085	2.16
Nickel Alloy Wound	.105	2.67
Nickel Alloy Wound	.130	3.29



MUSICAL EQUIPMENT

GUITAR STRINGS / ACCESSORIES

A607(4)-M

ELECTRIC BASS STRINGS

- Electric Bass Strings
- Steel Core
- Nickel Alloy Wound
- Plastic Bag



A607(4)-M KIT

	Inch	mm
Nickel Alloy Wound	.045	1.14
Nickel Alloy Wound	.065	1.65
Nickel Alloy Wound	.085	2.16
Nickel Alloy Wound	.105	2.67

A703

VIOLIN STRINGS

- Violin String
- Steel Core
- Nickel Silver Wound
- Plastic Bag

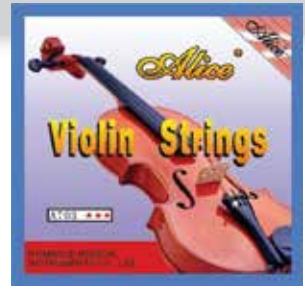

A703 KIT High-Grade

Steel Core, Nickel Alloy Wound  
Steel Core, Nickel Alloy Wound  
Steel Core, Nickel Alloy Wound

A703A KIT Middle-Grade

Stainless Steel  
Steel Core, Nickel Alloy Wound  
Steel Core, Nickel Alloy Wound  
Steel Core, Nickel Alloy Wound

A705

A705-1

VIOLIN STRINGS

- Violin String
- Coated Steel Core
- Nickel Chromium Wound
- Plastic Bag



AP-12C

GUITAR PICKS

- Celluloid Picks
- Constellation



A705 KIT

E-1st	Stainless Steel
A-2nd	Steel Core, Nickel Chromium Wound
D-3rd	Steel Core, Nickel Chromium Wound
G-4th	Steel Core, Nickel Chromium Wound
G-4th	Steel Core, Nickel Chromium Wound

AP-12G

GUITAR PICKS

- Projecting Nylon Guitar Picks
- Clamshell



AP-20N

GUITAR PICKS

- Celluloid Picks
- Assorted Colors
- 20 Pcs





# GUITAR ACCESSORIES / TAMBOURINES

## A025A

### PICKGUARD

- Guitar Pickguard
- Black



## A025B

### PICKGUARD

- Guitar Pickguard
- Colorful



## API00N

### GUITAR STRING

- Thump Picks
- Assorted Colors



## ATM-830 BLU

## ATM-830 GRN

### TAMBOURINE

- Hand-Held Tambourine with Metal Jingles
- Most Comfortable and Unique Design
- Natural Wrist Shake ever Produced
- High-Quality Metal Jingles
- Sonorous and Amusing Sound
- Careful Making
- Tambourine Popular Among the Music Lovers



## AP-180A

### GUITAR STRING

- Thump Picks
- Assorted Colors



## ATM-831 WHT

### TAMBOURINE

- Hand-Held Tambourine with Metal Jingles
- Most Comfortable and Unique Design
- Natural Wrist Shake ever Produced
- High-Quality Metal Jingles
- Sonorous and Amusing Sound
- Careful Making
- Tambourine Popular Among the Music Lovers



## ATM-810 BLU

## ATM-810 RED

## ATM-810 WHT

### TAMBOURINE

- Hand-Held Tambourine with Metal Jingles
- Most Comfortable and Unique Design
- Natural Wrist Shake ever Produced
- High-Quality Metal Jingles
- Sonorous and Amusing Sound
- Careful Making
- Tambourine Popular Among the Music Lovers





## MUSICAL EQUIPMENT

# TAMBOURINES

**ATM-818 BLU**

**ATM-818 GRN**

**ATM-818 RED**

**ATM-818 WHT**

### TAMBOURINE

- Hand-Held Tambourine with Metal Jingles
- Most Comfortable and Unique Design
- Natural Wrist Shake ever Produced
- High-Quality Metal Jingles
- Sonorous and Amusing Sound
- Careful Making
- Tambourine Popular Among the Music Lovers



**ATM-820 BLU**

**ATM-820 RED**

**ATM-820 WHT**

### TAMBOURINE

- Hand-Held Tambourine with Metal Jingles
- Most Comfortable and Unique Design
- Natural Wrist Shake ever Produced
- High-Quality Metal Jingles
- Sonorous and Amusing Sound
- Careful Making
- Tambourine Popular Among the Music Lovers



**ATM-DOV-8**

### TAMBOURINE

- 8" Tambourine



**ATM-DOV-10**

### TAMBOURINE

- 10" Tambourine



**ATM-HND8**

### TAMBOURINE

- 8" Tambourine



**ATM-HND10**

### TAMBOURINE

- 10" Tambourine





MUSICAL EQUIPMENT

TAMBOURINES

ATM-SHI-6

TAMBOURINE

- 6" Tambourine



ATM-SHI-8

TAMBOURINE

- 8" Tambourine



ATM-SHI-10

TAMBOURINE

- 10" Tambourine



ATM-W6

TAMBOURINE

- 6" Tambourine



ATM-W8

TAMBOURINE

- 8" Tambourine



ATM-W10

TAMBOURINE

- 10" Tambourine



CB6-DS7KT

DUAL 6" HAND HELD COW BELL

Cow Bell:

- Material: Iron
- Size: 5.1" x 2.8" x 5.9" (129 x 71 x 151mm)
- Weight: 1.15Lb (0.52Kg)
- Includes two

Drumsticks:

- 7A Wood Tip
- Oak Black Drumsticks
- Includes two





## COWBELLS

### ACB-05

#### 5" MOUNTABLE COWBELL FOR DRUMSET

- Designed with the Drum Kit Player in Mind
- High Grade 14-Gauge Steel
- Rich, Cutting Sound is Low Pitched and Moderately Dry



### ACB-06

#### 6" MOUNTABLE COWBELL FOR DRUMSET

- Designed with the Drum Kit Player in Mind
- High Grade 14-Gauge Steel
- Rich, Cutting Sound is Low Pitched and Moderately Dry



### BCB-06

#### 6" MOUNTABLE COWBELL FOR DRUMSET

- Designed with the Drum Kit Player in Mind
- High Grade 14-Gauge Steel
- Rich, Cutting Sound is Low Pitched and Moderately Dry
- 6"



### ACB-07

#### 7" MOUNTABLE COWBELL FOR DRUMSET

- Designed with the Drum Kit Player in Mind
- High Grade 14-Gauge Steel
- Rich, Cutting Sound is Low Pitched and Moderately Dry



### BCB-07

#### 7" MOUNTABLE COWBELL FOR DRUMSET

- Designed with the Drum Kit Player in Mind
- High Grade 14-Gauge Steel
- Rich, Cutting Sound is Low Pitched and Moderately Dry
- 7"



### ACBH-6

#### 6" HAND HELD COW BELL

- Material: Iron
- Size: 5.1" x 2.8" x 5.9" (129 x 71 x 151mm)
- Weight: 1.15Lb (0.52Kg)
- Hand Held
- Color: Black



### ACBP-5BL

#### 5" BLUE PERCUSSION

- Plastic Cowbell



### ACBP-6RD

#### 5" RED PERCUSSION

- Plastic Cowbell





MUSICAL EQUIPMENT

DRUMSTICKS

DS-M5A

DRUMSTICKS

- 5A Wood Tip
- Maple Drumsticks



DS-M5A-NL

DRUMSTICKS

- 5A Nylon Tip
- Maple Drumsticks



DS-M7A

DRUMSTICKS

- 7A Wood Tip
- Maple Drumsticks



DS-M7A-NL

DRUMSTICKS

- 7A Nylon Tip
- Maple Drumsticks



DS-M5B

DRUMSTICKS

- 5B Wood Tip
- Maple Drumsticks



DS-OK5A

DRUMSTICKS

- 5A Wood Tip
- Oak Drumsticks



DS-M7B

DRUMSTICKS

- 7B Wood Tip
- Maple Drumsticks



DS-OK7A

DRUMSTICKS

- 7A Wood Tip
- Oak Drumsticks



## DRUMSTICKS

### DS-OK5A-BLK

#### DRUMSTICKS

- 5A Wood Tip
- Oak Black Drumsticks



### DS-OK5A-NL

#### DRUMSTICKS

- 5A Nylon Tip
- Oak Drumsticks



### DS-OK7A-BLK

#### DRUMSTICKS

- 7A Wood Tip
- Oak Black Drumsticks



### DS-OK7A-NL

#### DRUMSTICKS

- 7A Nylon Tip
- Oak Drumsticks

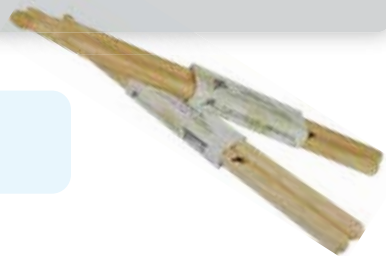

### DSME-5A-NL

#### 5A NYLON TIP MAPLE DRUMSTICKS

- Nylon Tip Drumstick
- Normal Size for Adult Use
- Made of Maple

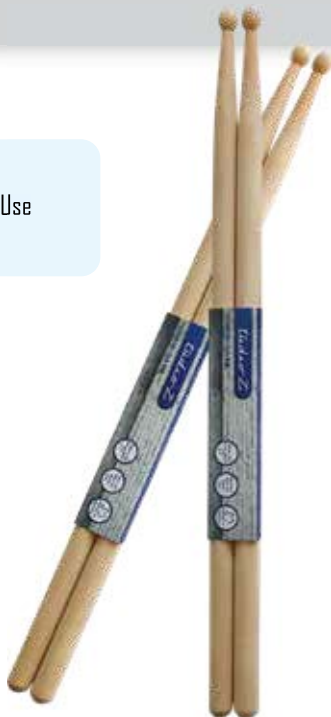

### DSME-7A-NL

#### 7A NYLON TIP MAPLE DRUMSTICKS

- Nylon Tip Drumstick
- Normal Size for Adult Use
- Made of Maple

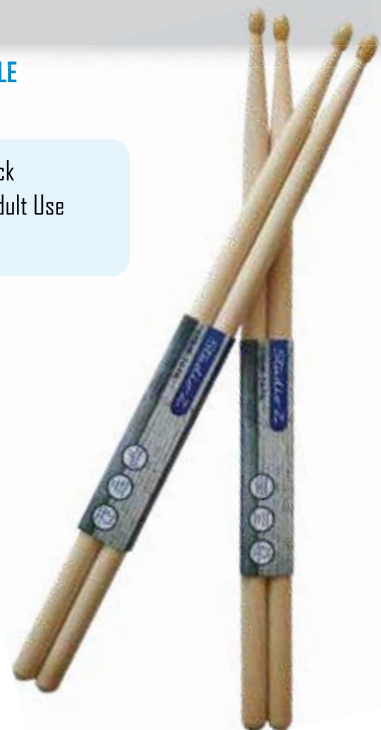



## MUSICAL EQUIPMENT

# TOLEDO GUITARS

### ACG-3910CEQ-SB

39" ELECTRO ACOUSTIC CUTAWAY GUITAR

- 5 Band EQ with Microphone
- LCD Display Screen, Chromatic Tuner Display
- Power: 1 x 9v Battery
- With 1/4" and XLR Socket Output
- Color: Sun Burst

Guitar Bag INCLUDED



### ACG-3910 BLK

39" ACOUSTIC GUITAR

- Color: Black

*Toledo*

Guitar Bag INCLUDED



### ACG-3910CEQ-WH

39" ELECTRO ACOUSTIC CUTAWAY GUITAR

- 5 Band EQ with Microphone
- LCD Display Screen, Chromatic Tuner Display
- Power: 1 x 9v Battery
- With 1/4" and XLR Socket Output
- Color: White

Guitar Bag INCLUDED



### ACG-3910CEQ-YH

39" ELECTRO ACOUSTIC CUTAWAY GUITAR

- 5 Band EQ with Microphone
- LCD Display Screen, Chromatic Tuner Display
- Power: 1 x 9v Battery
- With 1/4" and XLR Socket Output
- Color: Yellow

Guitar Bag INCLUDED



**ACG-3910BL**

39" ACOUSTIC GUITAR

- Color: Blue

Guitar Bag  
INCLUDED



**ACG-3910SB**

39" ACOUSTIC GUITAR

- Color: Sun Burst

Guitar Bag  
INCLUDED



**ACG-3910WH**

39" ACOUSTIC GUITAR

- Color: White

Guitar Bag  
INCLUDED



**ACG-3910YH**

39" ACOUSTIC GUITAR

- Color: Yellow

Guitar Bag  
INCLUDED



**EB-305BK**

5 STRING ELECTRIC BASS

- Construction Bolt-On
- Scale Length: 34"
- Fingerboard: Rosewood
- Radius: 10"
- Frets: 24
- Body: Alder
- Neck: Maple
- Bridge: Die-Cast
- Pickups: Humbucking Pickup X 2
- Controls: Master Volume, Pan-Pot, 2-Band EQ





MUSICAL EQUIPMENT

EQUALIZERS/PASSIVE DIRECT BOX

EQ-A4T

GUITAR EQUALIZER

- Digital 4-Band Equalizer



EQ-A300

GUITAR EQUALIZER

- 3-Band Equalizer



EQ-A500

GUITAR EQUALIZER

- 5-Band Equalizer



PS-500

MULTI-FUNCTION  
5-BAND EQUALIZER

- Volumen Control
- 5-Band Equalizer
- Low Battery Indicator



DB-01

PROFESSIONAL  
SINGLE-CHANNEL  
PASSIVE DIRECT BOX

- Input Attenuation: Switchable (0dB, -20dB, -40dB)
- Instrument Input: 50K Unbalanced TS Jack
- Parallel (Link) Out: 50K Unbalanced TS Jack
- Balanced Output: 600Ω Balanced XLR Jack
- Ground Lift: Switchable Ground Lift
- Construction: All Steel Chassis
- Dimensions: 4.7" x 3" x 1.8" (120 x 76.5 x 45mm)



**DB-02**

**PROFESSIONAL  
DUAL-CHANNEL  
PASSIVE DIRECT BOX**

- Input Attenuation: Switchable (0dB, -20dB, -40dB)
- Instrument Input: 50K Unbalanced TS Jack
- Parallel (Link) Out: 50K Unbalanced TS Jack
- Balanced Output: 600Ω Balanced XLR Jack
- Ground Lift: Switchable Ground Lift
- Construction: All Steel Chassis
- Dimensions: 5.3" x 3.7" x 1.6" (134 x 95 x 40mm)



**MTNR-7CLP**

**DIGITAL CLIP TUNER**

- Signal Receipt Method: MIC & CLIP
- A4 Frequency Range: 435~445Hz
- Tuning Mode: For Guitar, Bass & Violin
- Tuning Range: 0A~7C
- Tolerance: <math>\leq 1</math> Cent
- LDC Display: Color Back-Light Display
- Red to Green Status Indicator
- Battery: CR2032
- Size: 53x80x43(mm)
- Weight: 53G



**Battery  
INCLUDED**

**CRX-303**

**PASSIVE CROSSOVER**

- Max Power 300 Watts
- Impedance 4Ω
- Crossover Frequency  
Woofer: 20Hz-316Hz  
Midrange: 700Hz-4KHz  
Tweeter: 1.5Hz-20KHz



**PICKUP-50**

**STANDARD PICKUP**

- Easy to Install to Most Acoustical Instruments



**PICKUP-60V**

**PICKUP**

- Violin Pickup



**PICKUP-70G**

**GUITAR PICKUP**

- Exclusively for Acoustic Guitar
- Easy to Attach to Guitar



**PICKUP-105G**

**ACOUSTIC GUITAR PICKUP**

- Can Fit 3-11/16 to 4-1/8 (94-105mm) Sound Hole
- Excellent Bass Midrange Response and Soft Acoustic Tone



**GM-130**

**GUITAR PICKUP**

- Acoustic Guitar Pickup



**EQ-A7545R**

**ACOUSTIC GUITAR EQUALIZER**

- 4 Band Guitar Equalizer



**9V Battery INCLUDED**



MUSICAL EQUIPMENT

INSTRUMENTS / ACCESSORIES

**GUIRO-310B**

PERCUSSION INSTRUMENTS

- 15"
- Diameter 3"



**GUIRO-412**

PERCUSSION INSTRUMENTS

- 12"
- Diameter 4"



**GUIRO-512**

PERCUSSION INSTRUMENTS

- 12"
- Diameter 5"



**GUIRO-612**

PERCUSSION INSTRUMENTS

- 12"
- Diameter 6"



**ARC-820**

IVORY RECORDER

- Includes a Bag
- Lyons Recorder Cleaning Rod
- Approximately 12.50" Long

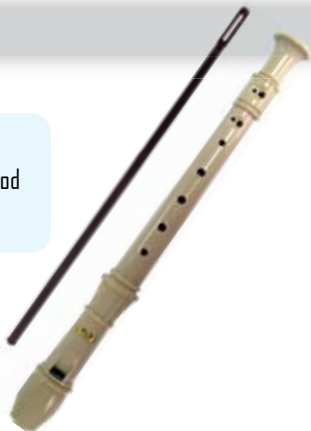

**AHM-160**

HARMONICA

- Metal & Wood
- Silver
- In C Key

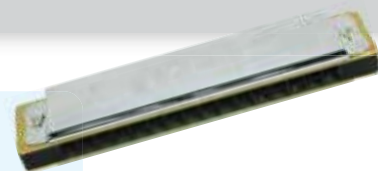

**AMRC-06**

MARACAS

- Plastic Concert Maracas with Wood Handles



**ABG-40**

BONGO

- 7" & 8" Wooden Shell





## GUITAR STRAP ACCESSORIES

**ZGS-1**

STRAP

- Guitar Strap



**ZGS-7**

STRAP

- Guitar Strap



**ZGS-8**

STRAP

- Guitar Strap



**ZGS-9**

STRAP

- Guitar Strap



**ZGS-10**

STRAP

- Guitar Strap



**ZGS-P140BK**

STRAP

- Guitar Strap



**ZGS-P140MI**

STRAP

- Guitar Strap



**A040-LB**

STRAP

- Guitar Strap





**ELECTRIC GUITARS & BASS  
EQUALIZERS/PASSIVE DIRECT BOX**

**A026A**

**A026B/IVY**

GUITAR NUT

- Acoustic Guitar Nut



**A026C**

**A026C/IVY**

GUITAR SADDLE

- Acoustic Guitar Saddle



**GUIRO-BRUSH-12**

GUIRO BRUSH

- Length: 305mm/12"



**FXC-61414**

JUMPER CABLES  
FOR GUITAR PEDALS

- 6 Color Coded: Red, Blue, Yellow, Green, Black & Purple

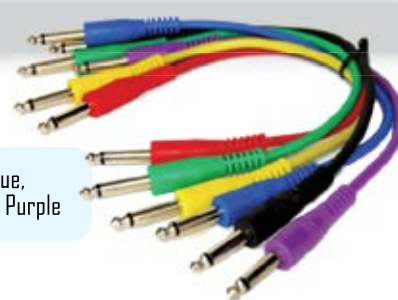

**CL-1001**

10" CLAVES

- Wood Color





MUSICAL EQUIPMENT

EQUALIZERS/PASSIVE DIRECT BOX

GB-12EL

GUITAR BAG

- Electrical Guitar Bag
- Non-Woven Fabric
- Pearl Cotton



GBN-01CL-39

GUITAR BAG

- 39" Guitar Strap



GBN-06CL-39

39" CLASSICAL GUITAR BAG

- Long Edge Zipper
- Two Shoulder Straps





MICROPHONES

*2022 CATALOG*



**DM-212 BLU**

DYNAMIC

- 600 Ohms
- 60-16K Hz
- -74 ± 3dB



**DM-301**

DYNAMIC

- Metal Construction
- 600 Ohms
- 60-16KHz @ 1KHz
- -74 ± 3dB



**DM-605**

DYNAMIC

- Metal Construction
- 600 Ohms
- 60~16KHz @ 1KHz
- -74 ± 3dB



**DM-18U**

PROFESSIONAL DYNAMIC MICROPHONE

- Uni-Directional Polar Pattern Reduces Pickup of Undesired Off-Axis Sound
- Professional Sound Quality for Vocals and Instruments
- Well Suited for on Stage Vocal/ Instrument Use as well as for the Karaoke Enthusiast
- Detachable Cable and Professional 3-Pin Output Connector
- Impedance: 600Ω ± 30%
- Sensitivity: -74dB ± 3dB
- Frequency Response: 60~15KHz



**DM-303BL**

PROFESSIONAL DYNAMIC MICROPHONE

- Dynamic Uni-Directional Microphone
- Impedance: 600 Ω ± 30%
- Sensitivity: -76dB ± 3dB
- Frequency Response: 70-14KHz
- Neodymium Magnet Ensures Optimum Sound Quality
- Double Dome Diaphragm for Well Balanced Sound Quality Ranging from the Lower to Upper Frequencies
- Alight Duty CCAW (Aluminum Wire) is used to Form the Voice Coil which helps Achieve Crystal Clear Sound Levels
- Reliable Canon Type Connector is Included

WIRED



Captures Sound From One Direction  
Unidirectional



Dynamic Uni-Directional



# MICROPHONES

# PROFESSIONAL MICROPHONES

## DM-28

### UNI-DIRECTIONAL DYNAMIC MICROPHONE

- Professional Sound Quality for Vocals and Instruments
- Unidirectional Polar Pattern Reduces Pickup of Undesired Off-Axis Sounds
- Well suited for on stage Vocal/Instrument Use as well as for the Karaoke Enthusiast
- Impedance: 600 Ohms
- Sensitivity: -52dB ± 3dB
- Frequency Response: 50 - 18KHz
- Plastic Body



## DM-38

### DYNAMIC MICROPHONE

- Professional Sound Quality for Vocals and Instruments
- Unidirectional Polar Pattern Reduces Pickup of Undesired Off-Axis Sounds
- Well Suited for on Stage Vocal/Instrument Use as well as for the Karaoke Enthusiast
- Impedance: 600 Ohms
- Sensitivity: -53dB ± 3dB
- Frequency Response: 40 - 17KHz
- Metal Body
- Switchless



## DM-48

### PROFESSIONAL DYNAMIC MICROPHONE

- Professional Sound Quality for Vocals and Instruments
- Unidirectional Polar Pattern Reduces Pickup of Undesired Off-Axis Sounds
- Well Suited for On-Stage Vocal/Instrument Use as well as for the Karaoke Enthusiast
- Dynamic Uni-Directional Microphone
- Impedance: 600 Ohms
- Sensitivity: -53dB ±3dB
- Frequency Response: 40-17KHz



## DM-88

### PROFESSIONAL DYNAMIC MICROPHONE

- Professional Sound Quality for Vocals and Instruments
- Unidirectional Polar Pattern Reduces Pickup of Undesired Off-Axis Sounds
- Well Suited for on Stage Vocal/Instrument Use as well as for the Karaoke Enthusiast
- Impedance: 600 Ohms
- Sensitivity: -53dB ± 3dB
- Frequency Response: 40 - 18KHz
- Metal Body
- Switchless



## DM-4750USB

### USB PC MICROPHONE

- Omnidirectional
- Pickup: 10mm electronic capacitive head
- Sensitivity: -42 dB
- Signal to noise ratio: <50 dB
- Frequency response: 100-10000Hz
- Impedance: 2.2k Ω
- Microphone: built-in
- USB cable length: 59' (150 cm)
- Supports Windows 2000/XP/7/8/9/10
- Dimensions: 3.9" x 3.1" x 0.5" (100 x 80 x 12 mm) Flexible gooseneck 9.6" (245 mm)
- Weight: 0.28 lbs. (129 gr)

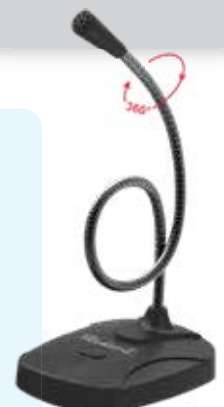

**MFLMS-3770**

**PORTABLE TRIPOD  
TV LCD/LED MOUNT**

- Output Impedance: 75 Ohms
- Power Supply: DC 3V / DC 48V
- Reference Sound-Receiving Distance: 20 - 50cm
- Capsule Type: Condenser
- Polar Pattern: Ultra-Cardioid
- Requery Response: 40Hz - 16KHz
- Sensitivity: -40±2dB

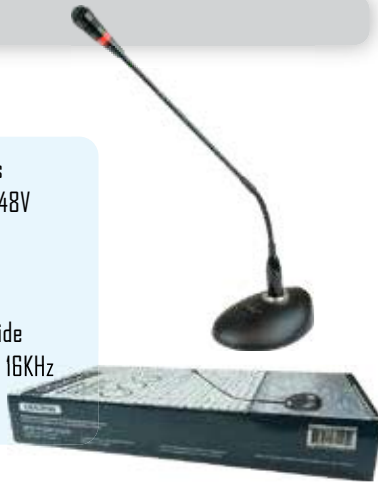

**DM-35ULN**

**PROFESSIONAL DYNAMIC MEETING  
MICROPHONE WITH BASE**

- Capsule Type: Condenser
- Polar Pattern: Cardioid
- Frequency Response: 40Hz~1.6KHz
- Sensitivity: -40±2dB
- Output Impedance: 200Ω Unbalanced
- Power Supply: Phantom48V/DC3V
- Mic Length: 19.5" (49.5cm)
- Extended Arm Length
- Unidirectional

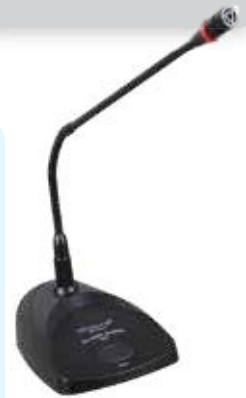

**GW-750**

**UNIDIRECTIONAL**

- 30 Meter Range
- 600 Ohms
- 100-10K Hz
- -72dB
- Includes Receiver, Antenna & Wire



**GW-3002**

**2 CHANNELS WIRELESS  
MICROPHONE SYSTEM**

- Using VHF 88 - 106MHz Band to Avert Interfering Frequencies
- Impedance: 600 Ohms
- Dynamic Range: >80dB
- Distortion Rate: <1%
- Frequency Response: 80 - 17KHz ± 3dB
- With Quartz Crystal



**GW-901**

**SINGLE CHANNEL FM WIRELESS MICROPHONE SYSTEM**

- Using VHF 200-270MHz Band to Avert Interfering Frequencies.
- Using Quartz Crystal Oscillating Circuits to Provide a Steady Frequency
- Specially Designed Compounding Circuit that Strongly Improves S/N Ratio
- Multi-Level Quiet Control Uses the Mutes System to Avoid Signal Interference on Activation and Shut Down
- Uses Dynamic Cardioid Direct Cartridge for Bright and Clear Sound
- Carrier Frequency: VHF 200-270MHz
- Stability: <±20ppm
- Dynamic Range: >90dB
- T.H.D.: <0.5%
- Frequency Response: 40Hz-15KHz ± 3dB
- Audio Out: 0-500mV



**GW-2001**

**SINGLE CHANNELS UHF WIRELESS MICROPHONE SYSTEM**

- Carrier Frequency: UHF 640~699MHz
- Stability: < +/- 20ppm
- Dynamic Range: >95dB
- T.H.D.: <1%
- Frequency Response: 50Hz~17Hz +/- 3dB
- Audio Out: 0~400mV
- Input: 100-240VAC 50/60Hz



**GW-2002**

**2 CHANNEL UHF WIRELESS MICROPHONE SYSTEM**

- Carrier Frequency: UHF 640~699MHz
- Stability:  $< \pm 20$ ppm
- Dynamic Range:  $>95$ dB
- T.H.D.:  $<1\%$
- Frequency Response: 50Hz~17KHz  $\pm 3$ dB
- Audio Out: 0~400mV



**GW-2003L**

**SINGLE CHANNEL UHF WIRELESS MICROPHONE SYSTEM**

- Carrier Frequency: UHF 640~699MHz
- Stability:  $< \pm 20$ ppm
- Dynamic Range:  $>95$ dB
- T.H.D.:  $<1\%$
- Frequency Response: 50Hz~17KHz  $\pm 3$ dB
- Audio Out: 0~400mV



**GW-5002**

**2 CHANNELS FM WIRELESS MICROPHONE SYSTEM**

- Using VHF200-270MHz Band to Avert Interfering Frequencies
- Using Quartz Crystal Oscillating Circuits to Provide a Steady Frequency
- Specially Designed Compounding Circuit that Strongly Improves S/N Ratio
- Multi-Level Quiet Control Circuit Uses the Mute System to Avoid Signal Interference on Activation and Shut Down
- Uses Dynamic Cardioid Direct Cartridge for Bright and Clear Sound
- With 1/4" Socket Conveniently Connects to Any Equipment
- With Quartz Crystal



**GW-6052**

**2 CHANNEL VHF WIRELESS MICROPHONE SYSTEM**

- Carrier Frequency: VHF 200 ~ 270MHz
- Uses a Quartz Crystal Oscillating Circuits to Provide a Steady Frequency
- Specially Designed Compounding Circuit that Strongly Improves S/N Ratio
- Multi-level Quiet Control Circuit Uses the Mute System to Avoid Signal Interference on Activation and Shut Down
- Uses Dynamic Cardioid Direct Cartridge for Bright and Clear Sound
- With 1/4" Socket Conveniently to Connect Any Equipment
- Stability:  $< \pm 20$ ppm
- Dynamic Range:  $> 110$ dB
- T.H.D.:  $< 0.5\%$
- Frequency Response: 50 ~ 18KHz  $\pm 3$ dB
- Battery: 4 AA 1.5V Storage Battery Professional Sound Quality for Vocals and Instruments
- Using Distance: 164ft ~ 328ft (50M ~ 100M)





**GW-7011**

**2 CHANNELS WIRELESS, MICROPHONE SYSTEM**

- Carrier Frequency: UHF 500-580MHz
- Stability:  $< \pm 20\text{ppm}$
- Dynamic Range:  $>98\text{dB}$
- T.H.D.:  $<0.5\%$
- Frequency Response: 40Hz-18 KHz  $\pm 3\text{dB}$
- Audio Out: Balanced: 0-700mV / Mix: 0-300mV



**GW-8002**

**FM WIRELESS MICROPHONE SYSTEM**

- Carrier Frequency: UHF 740 - 840MHz
- Stability:  $< \pm 20\text{ppm}$
- Dynamic Range:  $>98\text{dB}$
- T.H.D.:  $<0.5\%$
- Frequency Response: 40Hz - 18KHz  $\pm 3\text{dB}$
- Audio Out: Balanced: 0 - 700mV / Mix: 0 - 300mV

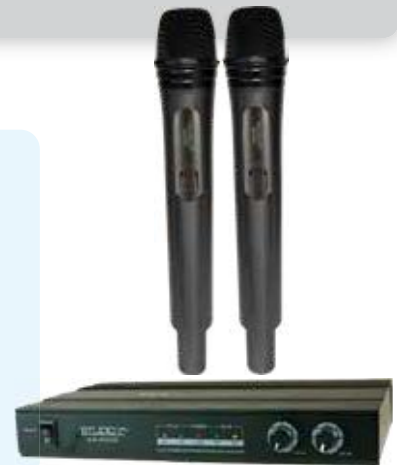

**GW-7011RBP**

**REPLACEMENT BODY PACKAGE**

**DM-37UD**

**PROFESSIONAL DYNAMIC MEETING MICROPHONE**

- Capsule Type: Condenser
- Polar Pattern: Cardioid
- 1/4" Mono XLR detachable Cable and professional 3-pin Output
- Frequency Response: 40Hz ~ 1.6KHz
- Sensitivity:  $-40\text{dB} \pm 2\text{dB}$
- Output Impedance: 200 $\Omega$  Unbalanced
- Power Supply: Phantom 48V / DC3V
- Mic Length: 19.5" (49.5 cm)



**GW-850**

**MULTIPURPOSE WIRELESS MICROPHONE WITH RECHARGEABLE RECEIVER**

- Frequency Range: 560-590Mhz
- Built in Lithium Battery: 3.7V/450mAh
- Signal/Noise Ratio:  $> 98\text{dB}$
- Channel Rejection Threshold:  $> 90\text{dB}$
- Spurious Response Rejection:  $> 90\text{dB}$
- Reception Sensitivity Higher than 5dBm
- Power Requirements: 2 AA batteries 1.5V (included)
- Modulation Type: FM
- RF Output: 15mW





# MICROPHONES

## PROFESSIONAL MICROPHONES

### GW-851BL

#### MULTIPURPOSE WIRELESS MICROPHONE WITH RECHARGEABLE RECEIVER

- Frequency Range: 560-590MHz
- Built in Lithium Battery: 3.7V/450mAh
- Signal/Noise Ratio: > 98dB
- Channel Rejection Threshold: > 90dB
- Spurious Response Rejection: > 90dB
- Reception Sensitivity Higher than 5dBm
- Power Requirements: 2 AA batteries 1.5V (included)
- Modulation Type: FM
- RF Output: 15mW



### STW-7902

#### WIRELESS MICROPHONE DUAL CHANNEL UHF

- Transmitter Power: < 30mW
- Spurious Emission: < 40dB (with Carrier)
- Battery Voltage: AA1.5v x 2
- Battery Life: > 10 Hours (Receiver) Desk-Top:
- Carrier Frequency Range: UHF 480~600 MHz
- Oscillation Mode: Quartz Controlled Fixed Frequency
- Stability: 10PPM
- Sensitivity: 2uV@sinad=12dB
- Maximum Deviation Range: 50KHz
- SIN Ratio: > 105dB
- T.H.D.: < 0.5%@ 1KHz
- Image Rejection: 85 dB Typical
- Spurious Rejection: 75 dB Typical
- Frequency Response: 50Hz~15KHz
- Squelch Control: Dual-Squelch Circuit
- Max. Output Level: Balanced: 0~400mv, Unbalanced: 0-300mv
- Power Supply: External DC Power Supply, 0.4A, 12~15VDC
- Dimensions: 8.2" x 5.4" x 1.5" (209 x 138 x 39mm)



### GW-R2000

#### 2 CHANNEL UHF WIRELESS MICROPHONE SYSTEM

##### Features:

- Wide Response Range
- Rechargeable Battery for Microphone
- In-Use, Reception and Transmission Indicators
- Two Antennas for Better Reception
- Volume Control
- Modulation in Frequency
- Balanced and Unbalanced Outputs
- 60 to 100m Range

##### Specifications:

- Microphone: Input: 3.7 V (Lithium Battery) 3 V (2xAA)

- Frequency Response: 50 Hz~20 KHz
- Frequency Stability: 0.005%
- Sensitivity: - 68 dB ± 3 dB
- SNR: >100 dB

##### Receiver:

- Input: 12 V 2A
- Impedance: 600 Ω
- AC/DC Power Converter
- Input: 100 - 240 V, 50 / 60 Hz, 1A
- Output: 12 V 2 A



Rechargeable



**GW-R101**

**UHF WIRELESS MICROPHONE WITH RECHARGEABLE RECEIVER**

**System Specifications**

- Modulation Mode: Digital Frequency Modulate
- Oscillation: PLL Synthesized
- Carrier Frequency Range: UHF 500~980MHz
- Preset Frequencies: 8 (Auto Pairing)
- Frequency Response: 75Hz~18kHz ± 3dB
- Max. Deviation Range: ±50kHz (with Level Limiting)
- T.H.D.: < 1.0% @ 1kHz
- S/N: >98dB
- Working Range: Up to 50m
- RF Carrier Stability: ±0.005% (-10°C-50°C)

**Mini Wireless Receiver (Metal):**

- Dimension: 95 x 31 x 16 mm

- Power Supply: Built-In Li-on Rechargeable Battery (500mA)
- Power Consumption: 80mA
- Battery Life: Up to 6 Hrs
- Recharging Time: About 1 Hour (5V/1A)

**Handheld Microphone (Metal):**

- Sound Cartridge: Dynamic
- Carrier Frequency Power: 30mw
- Battery Type: 2 x AA Size
- Working Time: Up to 10 hrs
- Dimension: 250 x 55 mm
- Weight: 350 g



**DMG-01G**

**METAL WELD, HARD AND DURABLE**

- Replaces Most Common Microphone Grills
- Outer Height: 53mm
- Outer Width: 54mm
- Inner Height: 52mm
- Inner Width at Base: 34mm



**S-1**

**FOAM BALL-TYPE MIC WINDSCREEN**

- Set of 5
- Assorted
- Outer Height: 63mm
- Outer Width: 55mm
- Inner Height: 60mm
- Inner Width: 52mm



**S-1B**

**FOAM BALL-TYPE MIC WINDSCREEN**

- Set of 5
- Black
- Outer Height: 63mm
- Outer Width: 55mm
- Inner Height: 60mm
- Inner Width: 52mm



**S-2B**

**LOT FLAT MICROPHONE WINDSCREEN FOAM COVER**

- Set of 5
- Black
- Outer Height: 63mm
- Outer Width: 55mm
- Inner Height: 60mm
- Inner Width: 52mm



**SM-PS15**

**POP SHIELD**

- High-Quality Acoustic Filter
- Prevents Pops when Recording Vocals
- Goose Neck for Precise Positioning
- Adjustable Clamp Mounts Securely to any Mic Stand



**CD-A1**

FOR DM-30I

- Pattern: Uni-Directional
- Frequency Response: 50~14KHz
- Sensitivity: -56dB ±3dB
- Output Impedance: 600Ω ±10%
- Outer Height: 43mm
- Outer Width at Base: 29mm



**CD-A2**

FOR GW-800Z

- Pattern: Uni-Directional
- Frequency Response: 40~18KHz
- Sensitivity: -53dB±3dB
- Output Impedance: 600Ω ±10%
- Outer Height: 55mm
- Outer Width at Base: 27mm



**CD-A3**

FOR PG48

- Pattern: Uni-Directional
- Frequency Response: 50~ 18KHz
- Sensitivity: -56dB±3dB
- Output Impedance: 500Ω ± 10%
- Outer Height: 40mm
- Outer Width: 30mm
- Outer Width at Base: 30



**CD-A4**

FOR DM-30I

- Pattern: Uni-Directional
- Frequency Response: 50~15KHz
- Sensitivity: -56dB ±3dB
- Output Impedance: 600Ω ±10%
- Outer Height: 47mm
- Outer Width at Base: 28mm



**CD-A5**

FOR DM-30I

- Pattern: Uni-Directional
- Frequency Response: 40~18KHz
- Sensitivity: -54dB ±3dB
- Output Impedance: 600Ω ±10%
- Outer Height: 40mm
- Outer Width: 28mm
- Outer Width at Base:28



**CD-A6**

FOR PG48

- Pattern: Uni-Directional
- Frequency Response: 50~ 15KHz
- Sensitivity: -56dB±3dB
- Output Impedance: 600Ω ±10%
- Outer Height: 42mm
- Outer Width: 30mm
- Outer Width at Base: 30



**CD-A9**

FOR DM-18K

- Pattern: Uni-Directional
- Frequency Response: 40~15KHz
- Sensitivity: -56dB ±3dB
- Output Impedance: 600Ω ±10%
- Outer Height: 43mm
- Outer Width: 32mm
- Outer Width at Base: 32



**CD-A8H**

FOR DM-38

- Pattern: Uni-Directional
- Frequency Response: 50~18KHz
- Sensitivity: -56dB ±3dB
- Output Impedance: 600Ω ±10%
- Outer Height: 60mm
- Outer Width at Base: 28mm



**CD-A8L**

FOR GW-6002

- Pattern: Uni-Directional
- Frequency Response: 50~18KHz
- Sensitivity: -56dB ±3dB
- Output Impedance: 600Ω ±10%
- Outer Height: 47mm
- Outer Width at Base: 28mm



**CD-A10**

FOR DM-P658

- Pattern: Uni-Directional
- Frequency Response: 50~18KHz
- Sensitivity: -55dB ±3dB
- Output Impedance: 600Ω ±10%
- Outer Height: 47mm
- Outer Width at Base: 29mm



**CD-A11**

FOR DM-605

- Pattern: Uni-Directional
- Frequency Response: 50~16KHz
- Sensitivity: -56dB ±3dB
- Output Impedance: 600Ω ±10%
- Outer Height: 52mm
- Outer Width at Base: 29mm



**CD-A12**

FOR DM-212

- Pattern: Uni-Directional
- Frequency Response: 50~14KHz
- Sensitivity: -56dB ±3dB
- Output Impedance: 600Ω ±10%
- Outer Height: 44mm
- Outer Width at Base: 29mm



**CD-B1**

FOR GW-901, GW-7011, GW-6002

- Pattern: Uni-Directional
- Frequency Response: 50~18KHz
- Sensitivity: -56dB ±3dB
- Output Impedance: 600Ω ±10%
- Outer Height: 50mm
- Outer Width at Base: 26mm



**CD-B2**

FOR GW-4004

- Pattern: Uni-Directional
- Frequency Response: 40~19KHz
- Sensitivity: -52dB ±3dB
- Output Impedance: 600Ω ±10%
- Outer Height: 53mm
- Outer Width at Base: 28mm



**CD-B3**

FOR DM-88

- Pattern: Uni-Directional
- Frequency Response: 40~19KHz
- Sensitivity: -52dB ±3dB
- Output Impedance: 600Ω ±10%
- Outer Height: 45mm
- Outer Width at Base: 28mm





DISCO  
LIGHT



*2022 CATALOG*

## ZYP-34R

### MINI LED PAR LIGHT

- Voltage: AC 110V
- Frequency: 50/60Hz
- Power Consumption: 20W
- Light Source: 3PCS RWGW 4-IN-1 LEDs
- Lens: 45 Degree
- LED Lifespan: 6-10 Thousand HRS
- Features: Outer Shell Made of Strong PVC, Light Weight, Durable, Good Heat Dissipation, High-Speed Chip Design, Connect 512 Signal Controller, can Pull up Numerous Kinds of Color Effects, Etc.
- Control Mode: DMX512 (8chs), Master/Slave, Auto, Sound Active
- Light Body: Black, Blue, and White Optional
- N.W: 0.66 LBS
- Dimensions: 4.7" x 4.7" x 3.9"



## ZYP-112

### LED STAGE LIGHT

- Power Supply: AC100-240V, 50-60Hz
- Rating Power: 12W
- Light Source: 18x0.5W (R6, G6, B6)
- Lamp Life: 50000 Hours
- Control Mode: Auto/Sound/DMX/Master-Slave
- DMX Channels: 7CH
- NW: 2 lbs (0.92Kg)
- Dimension: 7.9" x 3.9" x 9.1" (200 x 100 x 230mm)



## ZYP-118

### ZYP-118BAT

### LED STAGE LIGHT / BATTERY OPERATED

- Light Source: 18 x 1W / 6 x RGB
- Source Lifetime: Rated 50,000 Hours
- Power Supply: 100-240V/50-60Hz
- Power Rating: 24W
- Play Mode: Auto/Sound/DMX Master-Slave
- DMX Channel: 7
- Dimensions: 7.5" x 5.5" x 7.5" (190 x 140 x 190mm)
- Gross Weight: 2.03lbs (0.92Kg)





## LIGHTS

### ZYP-207W

#### LED STAGE LIGHT

- Power Supply: AC100~240V, 50~60Hz
- Rating Power: 32W
- Light Source: 7x 4W RGBW 4-IN-1 LED
- Lamp Life: 50,000 hours
- Control Mode: Auto/Sound/DMX/Masterslave
- DMX Channels: 8CH
- N.W.: 1.65Lbs (0.75KG)
- Dimension: 6.9" x 7.3" x 3.9"
- Application: Stage, Bar, Club, Party, Home Decoration, Hotel, Shopping Mall, Restaurant, Concert etc.



True  
White



### ZYB-13S

#### LED MAGIC BULB

- Power Supply: AC 110-240V, 50/60Hz
- Fitting Socket: E27
- 5V DC Motor with High Rotation Speed
- Automatic Operation
- Low Energy Consumption
- 2000 Operation Hours
- Compact & Lightweight, Easy to Use
- Colorful, Bright Light Effect Generated by 3 x RGB LEDs of 1W each
- Amazing Light Effect with Small Dimensions. Screw into an E27 Fitting to Create a Party Atmosphere at Home, in a Pub or During a Karaoke Party, Etc.
- Dimensions: 3.2" x 5"
- Weight: 0.22 Lbs



### ZYB-16

#### LED CRYSTAL BALL

- Power Supply: AC110V, 60Hz
- Power Consumption: 15W
- Lamp Life: 100,000 Hours
- Control Mode: Auto and Sound Activated
- Weight: 0.62 Lbs (280G)
- Dimensions: 5.3" x 5.3" x 5.3"
- Shell is made of ABS Plastic, Unique Optics Design System, Low Power Consumption, Super Luminance, Rich and Splendid Color
- **NO BATTERY REQUIRED**





**ZYB-32**
**LED MINI COLOR BALL**

- Voltage/Frequency: AC 110V/60Hz
- Power Consumption: 10W
- Lighting Source: 10mm LED Diodes, 39 LED Bulbs (Red, Green, Blue, White)
- Motor: 220V 5rpm
- Control Mode: Automatic
- Operating Environment: Indoor Use

**ZYB-36UB**
**LED CRYSTAL BALL WITH  
MUSIC PLAYER WITH BUILT IN SPEAKER**

- Light Source: 6 x 3W RGB LED
- Source Lifetime Rated 18000 Hours
- 2-Way Rotation
- Built-in Speaker
- Power Supply: 110V/50Hz
- Power Rating: 25W
- Operating Mode: Auto/Sound/BT
- SD Card Input and USB Port for Sound Controlled Operation

**ZYB-38U**
**LED SUN MAGIC BALL**

- Combined LED Magic Ball & UFO Light Effect for Table Top or Hanging
- Beams Light on the Wall and Lights Up the Room
- Power Supply: AC110, 60Hz
- Power Consumption: 20W
- Lamp Life: 100,000 Hours
- LEDs x 6 (R1, G1, B1, W1, A1, P1)
- Control Mode: Auto, Sound Operation
- Dances to the Beat
- Digital Display
- N.W.: 0.62 Lbs
- Dimensions: 7.1" x 7.1" x 6.3"

**ZYB-U08**
**UFO LED LIGHT**

- Power Supply: AC 110V, 60 Hz
- Light Source: 48 x f 10mm RGB (16R, 16G, 16B)
- Lamp Life: 20000 Hours
- Operating Modes: Auto & Sound
- Dimension: 5.1" x 5.1" x 1.7" (130 x 130 x 42mm)
- Weight: 0.33lb (150 G)
- Built-In Microphone can Trigger External Sound

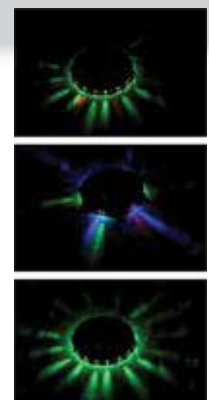

## ZYLL-93R

### LED LASER DERBY LIGHT

- 8x DMX Channels
- 9 x 3W LED: Red - Green/Blue/White/Amber/Pink/ Yellow/Orange/Violet
- 1 x 120mW Red Laser
- 1 x 30mW Green Laser
- 8 x Built-In Laser Shows
- Dimmer & Strobe
- Auto, Master-Slave, Sound-Controlled or DMX Operation
- Safety Switch and Remote Control
- Power Supply: 100V AC, 60Hz
- Consumption: 40W
- Laser Class: 3
- Dimensions: 7.3" x 6.4" x 8.3"
- Weight: 3.3 Lbs

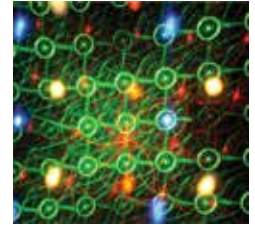

## ZYF-C34

### MINI LED DERBY

- Power Supply: AC 127V, 60Hz
- Power Consumption: 15W
- Light Source: 4 x 3W RGBW LEDs (RI, GI, BI, WI)
- Operating Mode: Auto, Sound
- Housing: Clear Plastic Housing
- Dimension: 6.9" x 4.5" x 5.8" (175x115x148mm)
- Net Weight: 0.84lbs (380 g)



## ZYMH-78

### MINI MOVING HEAD

- Light Source: 7x8W, 4-in-1 RGBW
- Power Supply: 100~240V AC, 50/60Hz
- Rated Power: 100W
- Control Mode: Sound/Auto/DMX/Master-Slave
- DMX Channel: 9/14
- Scanning Angle: Pan: 540°, Til: 270°
- Widely used in Small Stage, KYV, Bar, Disco Bar, Home Party, Wedding Party, Entertainment Show, etc.
- Dimension: 6.9" x 6.9" x 9.3" (175 x 175 x 235mm)
- Weight: 6 lbs (2.7 Kg)



**ZYMS-83**

**MINI LED SPIDER LIGHT**

- Voltage: 110V, 50/60Hz
- LEDs: 8pcs x 3W RGBW LEDs (2 Red, 2 Green, 2 Blue, 2 White)
- LED Lifespan: 50,000 Hours Rated
- Power Consumption: 46W
- Beam Angles: 4 Degrees
- Display: 4-Button LED Display
- Multi-Colors
- Operation Modes: 3 Operating Modes, Sound Active, Show Mode, and DMX Control
- Channel Modes: 7/13 Channel Mode
- Stand Alone or Master-Slave Setup
- N.W.: 4.85 Lbs
- Dimensions: 11" x 5.9" x 5.8"



**ZYST-118**

**18 PCS LED STROBE LIGHT**

- Voltage: 110V/60Hz
- Power Consumption: 18W
- Lighting Source: 18PCSx1W(R,G,B) LED
- Control Mode: Automatic, Sound Activated Sensitivity Adjustable
- Working Environment: Indoor Use



**ZYL-101**

**MINI LASER STAGE LIGHT**

- Projects Over 5000 Laser Beams and Motion Effects
- Boundless Fireflies are Projected as Stars in the Sky
- Widely Used in Family Parties, Suitable for Toy and Unique Gift etc.
- Sound/Auto/Strobe Control
- Speed/Sensitivity Adjustable
- Laser Power: Red>60mV, Green>8mV
- Input Power: DC 5V, 1A
- Dimension: 4.7" x 3.7" x 1.9" (120x94.5x49mm)
- Weight: 0.77lb (0.35Kg)



## ZYL-114RG

### LASER KALEIDOSCOPE

- Kaleidoscope of Various Patterns
- True Colorful Patterns such as Bubbles, Flowers, Flying Butterflies and Many More
- Patterns Move to the Beat Alternating Between Red and Green
- Colorful Patterns Display in Accordance with Music
- Sound/Auto Control
- Laser Power: Red: 100mW, Green: 25-45mW
- Input Power: DC 5V, 1A
- Dimension: 5.1" x 6.3" x 2.6" (130x160x65mm)
- Weight: 2lb (0.9Kg)



## ZYL-302R

### LED STAGE LIGHT

- Voltage/Frequency: 100-240V/50-60Hz
- Lighting Source: 252 LED/84 x RGB
- LED Section: 8 Sections
- Power Consumption: 36W
- Control Mode: Automatic, Sound, DMX, Master-Slave
- DMX Channel: 2, 3, 4, 7, 14, 26
- Light Angle: 40°
- Effect: Color-Mixing Wash Wall Effect
- Dimensions: 39.8" x 2.4" x 2.4" (1010 x 60 x 60mm)
- Gross Weight: 3.73Lbs (1.69Kg)
- Standard Configuration: Power Cable



## ZYLB-10253-28

### LED STAGE LIGHT

- Voltage/Frequency: 100-240V/50-60Hz
- Lighting Source: 252 LED/84 x RGB
- LED Section: 8 Sections
- Power Consumption: 36W
- Control Mode: Automatic, Sound, DMX, Master-Slave
- DMX Channel: 2, 3, 4, 7, 14, 26
- Light Angle: 40°
- Effect: Color-Mixing Wash Wall Effect
- Dimensions: 39.8" x 2.4" x 2.4" (1010 x 60 x 60mm)
- Gross Weight: 3.73Lbs (1.69Kg)
- Standard Configuration: Power Cable



**ZSM-401L**
**400W TRANSPARENT HOUSING FOG MACHINE**

- Voltage: AC 110V
- LED Color: Each 3W LED Contains 3 Colors in 1
- Power: 400W
- Heat-Up Time: 8 Minutes
- Tank Capacity: 0.3L
- Projection Distance: 3.5M
- Smoke Output: 14M3/Min
- Control Mode: Wired Remote Control
- Weight: 1.8KG
- Dimensions: 290 x 150 x 140mm

**ZSM-403SLED**
**400W LED FOG MACHINE**

- Voltage: 110V, 50Hz
- LED Color: 3PCS 1W RGB 3 in 1
- Power Consumption: 400W
- Heat-Up Time: 5 Minutes
- Tank Capacity: 0.3L
- Projection Distance: 3.5M
- Smoke Output: 14M / Min
- Control Mode: Wired Remote Control
- Weight: 1.8Kg
- Dimensions: 290x150x140mm

**ZSM-1006SLED**
**PROFESSIONAL 950W FOG MACHINE**

- Voltage: 110V, 60Hz
- Power: 950W
- Tank Capacity: 1 Litre
- Light Source: 6 Pcs x 3W 3 in 1 LED
- Heat-Up Time: 5 Min
- Fog Volume: 18000 cu.ft/min
- Remote Control Range: 20M
- Control Mode: DMX / Wire Control and Wireless Remote Control
- Weight: 7 Lbs (3.2KG)
- Dimensions: 15.7" x 9.4" x 7.9" (400 x 240 x 200mm)





## FOG MACHINES / FLUIDS

### ZSM-1500R

WIRELESS REMOTE OR MANUALLY TRIGGERED MACHINE

- Voltage: 110V, 50/60Hz
- Power: 1500W
- Nozzle Heating Time: 10 Min
- Fog Volume: 166 M2/Min
- Pot of Capacity: 2.3 L
- Spray Smoke Height: 7M
- Control System: Wire Control/Remote Control
- Remote Control Range: 25M
- The Shell: Resin Powder Coating Metal Plate
- Matching Control: Remote Control Using the Same Code as Synchronous Control, Delay Error 0.1-0.5 Seconds
- Weight: 11Lbs (5kg)
- Dimensions: 18.5" x 12.2" x 7.9"



### ZSM-900ULED

PROFESSIONAL 900W FOG MACHINE

- Voltage: 110V, 60Hz
- Power: 900W
- Tank Capacity: 1 Litre
- Light Source: 6 Pcs x 3W 3 in 1 LED
- Heat-Up Time: 5 Min
- Fog Volume: 18000 cu.ft/min
- Remote Control Range: 20M
- Control Mode: DMX / Wire Control and Wireless Remote Control
- Weight: 6.2 Lbs (2.8KG)
- Dimensions: 13.4" x 11" x 6.3"



### TF-025

FOG FLUID

- Compatible with Water-Based Machines
- 1 Quart (946L)



**TF-100**

**FOG FLUID**

- Compatible with Water-Based Machines
- 1 Gallon (3.785L)



**TFS-20Z-MM**

**FLUID SCENT**

- Mojito Mint
- 2 Fl. Oz. (60mL)



**TFS-20Z-PM**

**FLUID SCENT**

- Pepper Mint
- 2 Fl. Oz. (60mL)



**TLS-160MJ**

**DISCO LIGHT STAND**

- Minimum Height: 1.4m
- Maximum Height: 3.5m
- Weight: 7kg (15.4 lbs)



**TLS-275MJ**

**DISCO LIGHT STAND**

- Ideal for Light Weight Lighting Fixtures
- Great for Night Clubs, Mobile Dj'S and any Occasion
- Fast and Easy Setup
- Conveniently Holds up to 8 Disco Lights
- Minimum Height: 4.8' (1.45M)
- Maximum Height: 11.5' (3.5M)
- Arm Length: 3.9' (1.2M)
- Load Capacity: 132.3Lbs (60Kg)
- Net Weight: 15.4Lbs (7Kg)



**Metal Joints**

**Adjustable  
Stabilization**



**Adjustable  
Height**

## TLS-350MJ

### PORTABLE TRUSS SYSTEM

- Ideal for Light Weight Lighting Fixtures
- Great for Night Clubs, Mobile DJ's and any Occasion
- Fast and Easy Set Up
- Conveniently Holds up to 20 Disco Lights
- Minimum Height: 5.9' (1.8M)
- Maximum Height: 11.5' (3.5M)
- Arm Length: 3.9' (1.2M)
- Pipe Length: 9.8' (3M)
- Load Capacity: 242.5 Lbs (110Kgs)
- Net Weight: 44.1 Lbs (20Kgs)



## ZY-CL3548-80K

### DISCO LIGHT CLAMP

- Diameter: 35mm to 48mm
- Supports up to 80kg (176 lbs)



## ZY-CL4252-100K

### DUAL SWIVEL DISCO LIGHT CLAMP

- Fits on a 40mm - 52mm Truss
- Maximum Bearing Weight of 100Kg
- Made of Polished Cast-Aluminum
- Suitable for moving Head Light, LED Par Light, LED Par Can, Disco Light, DJ Light Etc.

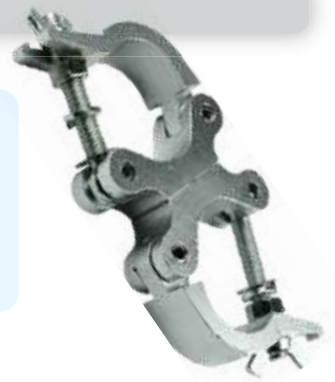

## ZY-CL4252-200K

### DISCO LIGHT CLAMP

- Diameter: 42mm to 52mm
- Supports up to 200kg (440 lbs)



## ZLPB-A275L

### LED PARTYBAR

- 2 x PAR Cans Fitted with 3pcs 4 IN 1 4W LEDs
- 2 x LED Derby Effects with 4 x 3W LEDs
- 1x Laser 30mw 532nm Green Diode + 100mw 650nm Red Diode
- 1x Wireless Foot Pedal
- 1x Remote Controller
- 1x Power Cable 3M
- 1x Stand 2.5M
- 1x Black Bag
- Crossbar that Powers the PAR Cans
- 3/7/16-Channel DMX, Master-Slave, Auto & Remote Control
- Pre-Mounted DMX Signal Cable on all 4 x Cans
- Voltage: AC110V, 50/60Hz
- Power: 60W
- Height: 2.5m Maximum
- Weight: 14.6 Lbs (6.6kg)
- Dim: 37.8" x 11" x 6.7" (960 x 280 x 170mm)
- Features: Plug and Play, Easy to Use, Sound Active, Auto Mode, Remote Control, Foot Pedal Control, Transparent Enclosure, High Light Output, Energy Saving
- LEDs Create Super Full Color Wash Effect
- Set Up and Ready to Rock the Stage in Minutes
- Individual Position Per Par Can
- Can be Mounted on the Supplied Lighting Stand

Now With Laser



Max Height 8' - 2"





## ZLPB-B265

### LED PARTY BEAM LIGHT BAR W/BAG

- Remote Control
- Power Cable 4m
- Crossbar that Powers the PAR Cans
- 2 x PAR Cans Fitted with 12 x 1W RGBW LEDs
- 2 x Moon Flower Effects with RGBWA LEDs
- 3/6/15-Channel DMX, Master Slave, Auto, and Remote Control
- Pre-Mounted DMX Signal Cable on all 4 Cans
- 2 x Travel bags
- Features: Plug and Play, Easy to Use, Sound Active or Auto Mode, High Light Output, Energy Saving
- LED's Create Super Full Color Wash Effect
- Set Up and Ready to Rock the Stage in Minutes
- Can be Mounted on the Supplied Lighting Stand
- Individual Position per PAR Can
- Pre-Mounted DMX Signal Cable on all 4 Cans
- Voltage: AC110V, 50/60Hz
- Power: 60W
- Dimensions: 31.5" x 9" x 6.7"
- Height: 6 Ft Maximum
- Weight: 12.3 Lbs



## ZLPB-D243

### LED PARTY DERBY LIGHT BAR W/BAG

- Remote Control
- Power Cable 4m
- Crossbar that Powers the PAR Cans
- 2 x PAR Cans Fitted with 12 x 1W RGBW LEDs
- 2 x Moon Flower Effects with RGBWA LEDs
- 3/6/15-Channel DMX, Master Slave, Auto, and Remote Control
- Pre-Mounted DMX Signal Cable on all 4 cans
- 2 x Travel Bags
- Features: Plug and Play, Easy to Use, Sound Active or Auto Mode, High Light Output, Energy Saving
- LED's Create Super Full Color Wash Effect
- Set Up and Ready to Rock the Stage in Minutes
- Can be Mounted on the Supplied Lighting Stand
- Individual Position per PAR Can
- Pre-Mounted DMX Signal Cable on all 4 Cans
- Voltage: AC110V, 50/60Hz
- Power: 60W
- Dimensions: 31.5" x 9" x 6.7"
- Height: 6 FT Maximum
- Weight: 12.3 Lbs



## ZLPB-244

### LED PARTY DERBY LIGHT BAR WITH BAG

- 2 x PAR cans fitted with 12 x 1W RGBW LEDs
  - 2 x LED Derby effects with 4 x 3W LEDs
  - Crossbar that powers the PAR cans
  - Auto & remote control, sound control
  - Power Cable 1ft (3m)
  - Features:
    - Plug and play
    - Easy to use
    - Sound active or auto mode
    - High light output
    - Energy savings
    - LEDs create super full color wash effect
    - Set up and get ready to rock the stage
    - Adjustable position per par can
    - Can be mounted on the supplied lighting stand
- Specifications:**
- Voltage: 110 ~ 240V AC, 50/60Hz
  - Power: 60W
  - Height: 2.5 Max
  - Weight: 12.3 Lbs (5.6 Kg)
  - Dimensions: 31.5" x 9" x 6.7" (800 x 230 x 170 mm)



Easy to use with 3 simple mode options:





**STANDS / ACCESSORIES**

**ZYD-DMX512**

**PROFESSIONAL LIGHTING DMX CONTROLLER**

- Voltage: AC110V/60Hz
- Electric Current: No Less Than 300mA
- Power Consumption: 5W
- External Power Transformer
- Fast Programming, Memorizes the Program, LCD Display, Easy Operation
- Standard DMX 512 Signal
- MID: IN/OUT, Built-In Mic Input
- This Controller has 8 Outlets /192 DMX 512 Channels Output it can Control up to 12 Moving Lights (EACH Outlets has 16 Channels)



**ZPC-8000**

**RACK MOUNT POWER STRIP**

- Voltage: 110V/60Hz
- Includes 8 Outlets
- Offers 15 Amp AC Power Distribution
- Rack Mountable Using 1 Rack Space (1U)



**ZMB-16 (16" Mirror Ball)**

**SINGLE COLOR MIRROR BALL WITH MOTOR**

- Polyfoam Inner Ball
- ABS Center Core
- Available in 12", 16", 20"



**ZMR-3MTR**

**MIRROR BALL MOTOR**

- Power: 110-120V, 50/60Hz, 4W
- Motor Speed: 2.5-3 RPM
- Fits up to 12" & 16"



**ZDMX-3XLRMF-12B**

**3 PIN XLR MALE TO XLR FEMALE DMX CABLE**

- 12"
- Premium Jacket Materials Provide Ease of Handling and Long Service Life
- Bright Nickel-Plated Connectors for Long Term Good Looks and Conductivity
- 24 AWG Oxygen-Free Copper Stranded Conductors for Maximum Signal Transfer



**ZDMX-3XLRMF-20B**

**3 PIN XLR MALE TO XLR FEMALE DMX CABLE**

- 20"
- Premium Jacket Materials Provide Ease of Handling and Long Service Life
- Bright Nickel Plated Connectors for Long Term Good Looks and Conductivity
- 24 AWG Oxygen-Free Copper Stranded Conductors for Maximum Signal Transfer



**ZDMX-3XLRMF-30B**

**3 PIN XLR MALE TO XLR FEMALE DMX CABLE**

- 30"
- Premium Jacket Materials Provide Ease of Handling and Long Service Life
- Bright Nickel Plated Connectors for Long Term Good Looks and Conductivity
- 24 AWG Oxygen-Free Copper Stranded Conductors for Maximum Signal Transfer



**ZDMX-5XLRMF-12B**

**5 PIN XLR MALE TO XLR FEMALE DMX CABLE**

- 12"
- Premium Jacket Materials Provide Ease of Handling and Long Service Life
- Bright Nickel Plated Connectors for Long Term Good Looks and Conductivity
- 24 AWG Oxygen-Free Copper Stranded Conductors for Maximum Signal Transfer



**ZDMX-5XLRMF-20B**

**5 PIN XLR MALE TO XLR FEMALE DMX CABLE**

- 20"
- Premium Jacket Materials Provide Ease of Handling and Long Service Life
- Bright Nickel Plated Connectors for Long Term Good Looks and Conductivity
- 24 AWG Oxygen-Free Copper Stranded Conductors for Maximum Signal Transfer



**ZDMX-5XLRMF-30B**

**5 PIN XLR MALE TO XLR FEMALE DMX CABLE**

- 30"
- Premium Jacket Materials Provide Ease of Handling and Long Service Life
- Bright Nickel Plated Connectors for Long Term Good Looks and Conductivity
- 24 AWG Oxygen-Free Copper Stranded Conductors for Maximum Signal Transfer





**POWER  
PRODUCTS**

***2022 CATALOG***



**RB4-6**

**RECHARGEABLE BATTERY**

- Nominal Voltage (V): 6
- Nominal Capacity (20H.R) (AH): 4.5
- Length:(in)2.76 (mm)70
- Width:(in)1.89 (mm)48
- Height:(in)3.98 (mm)101
- With Terminal: (in)4.21 (mm)107
- Weight: (Lbs) 1.63 (kgs) 0.74



**4AMPS / 6VOLTS**

**RB7-12**

**RECHARGEABLE BATTERY**

- Nominal Voltage (V): 12
- Nominal Capacity (20H.R) (AH): 7
- Length:(in)5.95 (mm)151
- Width:(in)2.56 (mm)65
- Height:(in)3.7 (mm)94
- With Terminal: (in)3.94 (mm)100
- Weight: (Lbs) 4.96 (kgs)2.25



**7AMPS / 12VOLTS**

**RB8-6**

**RECHARGEABLE BATTERY**

- Nominal Voltage (V): 6
- Nominal Capacity (20H.R) (AH): 8
- Length:(in)5.95 (mm)151
- Width:(in)1.97 (mm)50
- Height:(in)3.7 (mm)94
- With Terminal: (in)3.94 (mm)100
- Weight: (Lbs) 3.41 (kgs) 1.55



**8AMPS / 6VOLTS**

**RB9-12**

**(REPLACEMENT FOR ER-770)**

- Nominal Voltage (V): 12
- Nominal Capacity (20H.R) (AH): 9
- Length:(in)5.95 (mm)151
- Width:(in)2.56 (mm)65
- Height:(in)3.7 (mm)94
- With Terminal: (in)3.94 (mm)100
- Weight: (Lbs) 5.3 (kgs)2.40



**9AMPS / 12VOLTS**

**RB10-6**

**RECHARGEABLE BATTERY**

- Nominal Voltage (V): 6
- Nominal Capacity (20H.R) (AH): 10
- Length:(in)5.95 (mm)151
- Width:(in)1.97 (mm)50
- Height:(in)3.7 (mm)94
- With Terminal: (in)3.94 (mm)100
- Weight: (Lbs) 4.17 (kgs)1.89



**10AMPS / 6VOLTS**

**RB10-12**

**RECHARGEABLE BATTERY**

- Nominal Voltage (V): 12
- Nominal Capacity (20H.R) (AH): 10
- Length:(in)5.95 (mm)151
- Width:(in)3.9 (mm)99
- Height:(in)3.74 (mm)95
- With Terminal: (in)3.97 (mm)101
- Weight: (Lbs) 8.6 (kgs)3.9



**10AMPS / 12VOLTS**

**RB12-12**

**RECHARGEABLE BATTERY**

- Nominal Voltage (V): 12
- Nominal Capacity (20H.R) (AH): 12
- Length:(in)5.95 (mm)151
- Width:(in)3.9 (mm)99
- Height:(in)3.74 (mm)95
- With Terminal: (in)3.97 (mm)101
- Weight: (Lbs) 8.6 (kgs)3.9



**12AMPS / 12VOLTS**

**RB17-12**

**RECHARGEABLE BATTERY**

- Nominal Voltage (V): 12
- Nominal Capacity (20H.R) (AH): 17
- Length:(in)7.13 (mm)181
- Width:(in)2.99 (mm)76
- Height:(in)6.57 (mm)167
- With Terminal: (in)6.57 (mm)167
- Weight: (Lbs) 14.32 (kgs)6.5



**17AMPS / 12VOLTS**

**RECHARGEABLE BATTERIES**

**RB2.6-12**

**RECHARGEABLE BATTERY**

- Sealed Lead-Acid Rechargeable Battery



**2.6AMPS / 12VOLTS**

**RB4-3**

**RECHARGEABLE BATTERY**

- 4V, 3.0Ah
- Cycle Use: 4.80V-5.00V
- Standby Use: 4.50V-4.60V
- Maximum Charging Current: 0.90A



**3AMPS / 4VOLTS**

**RB2.8-6**

**RECHARGEABLE BATTERY**

- Sealed Lead-Acid Rechargeable Battery



**2.8AMPS / 6VOLTS**

**RB4-4**

**SEALED LEAD-ACID RECHARGEABLE BATTERY**

- 4 Amp
- 4 Volt
- Dimensions (LxWxH): 1.85" x 1.85" x 4.25"



**4AMPS / 4VOLTS**

**RB4-12**

**RECHARGEABLE BATTERY**

- 4 Amp 12 Volt



**4AMPS / 12VOLTS**

**RB4.5-12**

**RECHARGEABLE BATTERY**

- For **STAND-BY USE**  
Charging Voltage: 6V (6.8-6.9) 12V (13.6-13.7)
- For **CYCLE USE**  
Charging Voltage: 6V (7.3-7.5) 12V (14.6-15.0)
- Charging Current (A): 0.1C-0.25C "C" means Ah Value of Battery Rated Capacity



**3AMPS / 4VOLTS**

**RB40-12**

**RECHARGEABLE BATTERY**

- 40 Amp 12 Volt



**40AMPS / 12VOLTS**

**RB65-12**

**RECHARGEABLE BATTERY**

- Maintenance - Free
- 12V - 65Ah



**65AMPS / 12VOLTS**

**RBV10-6**  
RECHARGEABLE BATTERY

- Valve regulated lead acid battery

**10AMPS / 6VOLTS**



**RBV12-12**  
RECHARGEABLE BATTERY

- Valve regulated lead acid battery

**12AMPS / 12VOLTS**



**RBV2.8-6**  
RECHARGEABLE BATTERY

- Valve regulated lead acid battery

**2.8AMPS / 6VOLTS**



**RBV4-12**  
RECHARGEABLE BATTERY

- Valve regulated lead acid battery

**4AMPS / 12VOLTS**



**RBV4-4**  
RECHARGEABLE BATTERY

- Valve regulated lead acid battery

**4AMPS / 4VOLTS**



**RBV4-6**  
RECHARGEABLE BATTERY

- Valve regulated lead acid battery

**4AMPS / 6VOLTS**



**RBV4.5-12**  
RECHARGEABLE BATTERY

- Valve regulated lead acid battery

**4.5AMPS / 12VOLTS**



**RBV5-6**  
RECHARGEABLE BATTERY

- Valve regulated lead acid battery

**5AMPS / 6VOLTS**



## RECHARGEABLE BATTERIES

### RBV7-12

RECHARGEABLE BATTERY

- Valve regulated lead acid battery

**7AMPS / 12VOLTS**



### RBV8-6

RECHARGEABLE BATTERY

- Valve regulated lead acid battery

**8AMPS / 6VOLTS**



### RBV9-12

RECHARGEABLE BATTERY

- Valve regulated lead acid battery

**9AMPS / 12VOLTS**



### RBV10-6

RECHARGEABLE BATTERY

- Valve regulated lead acid battery

**10AMPS / 6VOLTS**



### RBV12-12

RECHARGEABLE BATTERY

- Valve regulated lead acid battery

**12AMPS / 12VOLTS**



### RBV17-6

RECHARGEABLE BATTERY

- Valve regulated lead acid battery

**17AMPS / 6VOLTS**





- AR-500** (500 Watts)
- AR-1000** (1000 Watts)
- AR-2000** (2000 Watts)
- AR-3000** (3000 Watts)
- AR-5000** (5000 Watts)

**VOLTAGE REGULATOR**

- Input: 180-260V, 75-130V
- Output: 110V/220V
- Phase: Single
- Frequency: 50/60Hz



**Automatic Voltage Regulator**  
*Regulador Automático de Voltaje*

**na**

**Features:**

- Regulates wide range of voltage, allowing electric loads to be used during voltage fluctuations
- Equipped with delay output protection circuit
- Equipped with protection device for exceeding high voltage

**AR-5000**

**Características:**

- Regula amplia gama de voltaje, permitiendo utilizar artefactos eléctricos durante las fluctuaciones de tensión.
- Equipado con circuito de protección de salida de retardo
- Equipado con un dispositivo de protección por exceso de alta tensión

**Automatic Voltage Regulator**  
*Regulador Automático de Voltaje*

**na**

**Features:**

- Regulates wide range of voltage, allowing electric loads to be used during voltage fluctuations
- Equipped with delay output protection circuit
- Equipped with protection device for exceeding high voltage

**AR-500**

**Características:**

- Regula amplia gama de voltaje, permitiendo utilizar artefactos eléctricos durante las fluctuaciones de tensión.
- Equipado con circuito de protección de salida de retardo
- Equipado con un dispositivo de protección por exceso de alta tensión

**Automatic Voltage Regulator**  
*Regulador Automático de Voltaje*

**na**

**Features:**

- Regulates wide range of voltage, allowing electric loads to be used during voltage fluctuations
- Equipped with delay output protection circuit
- Equipped with protection device for exceeding high voltage

**AR-2000**

**Características:**

- Regula amplia gama de voltaje, permitiendo utilizar artefactos eléctricos durante las fluctuaciones de tensión.
- Equipado con circuito de protección de salida de retardo
- Equipado con un dispositivo de protección por exceso de alta tensión

**Automatic Voltage Regulator**  
*Regulador Automático de Voltaje*

**na**

**Features:**

- Regulates wide range of voltage, allowing electric loads to be used during voltage fluctuations
- Equipped with delay output protection circuit
- Equipped with protection device for exceeding high voltage

**AR-3000**

**Características:**

- Regula amplia gama de voltaje, permitiendo utilizar artefactos eléctricos durante las fluctuaciones de tensión.
- Equipado con circuito de protección de salida de retardo
- Equipado con un dispositivo de protección por exceso de alta tensión

**Automatic Voltage Regulator**  
*Regulador Automático de Voltaje*

**na**

**Features:**

- Regulates wide range of voltage, allowing electric loads to be used during voltage fluctuations
- Equipped with delay output protection circuit
- Equipped with protection device for exceeding high voltage

**AR-1000**

**Características:**

- Regula amplia gama de voltaje, permitiendo utilizar artefactos eléctricos durante las fluctuaciones de tensión.
- Equipado con circuito de protección de salida de retardo
- Equipado con un dispositivo de protección por exceso de alta tensión

## ASERV-2000C

### 2KVA AUTOMATIC VOLTAGE REGULATOR

- Servo Motor Transformer
- Wide Input Voltage Range: 80-260V
- Dual Output: 110V AC and 220V AC at the Same Time
- Advanced CPU Control Circuit
- Automatic 10 Second Countdown Delay Function Integrate
- Full Protection Design: High Voltage/Low Voltage/High Temperature/Short Circuit
- Accurate Output Regulation:  $\pm 3\%$



## ASERV-3000C

### 3KVA AUTOMATIC VOLTAGE REGULATOR

- Servo Motor Transformer
- Wide Input Voltage Range: 80-260V
- Dual Output: 110V AC and 220V AC at the Same Time
- Advanced CPU Control Circuit
- Automatic 10 Second Countdown Delay Function Integrate
- Full Protection Design: High Voltage/Low Voltage/High Temperature/Short Circuit
- Accurate Output Regulation:  $\pm 3\%$



## ASERV-5000C

### 5KVA AUTOMATIC VOLTAGE REGULATOR

- Servo Motor Transformer
- Wide Input Voltage Range: 80-260V
- Dual Output: 110V AC and 220V AC at the Same Time
- Advanced CPU Control Circuit
- Automatic 10 Second Countdown Delay Function Integrate
- Full Protection Design: High Voltage/Low Voltage/High Temperature/Short Circuit
- Accurate Output Regulation:  $\pm 3\%$



## DC POWER SUPPLY/AUTOMATIC VOLTAGE REGULATORS

**ATVR-500 (500 VA)**  
**ATVR-1000 (1000 VA)**  
**ATVR-2000 (2000 VA)**  
**VOLTAGE REGULATOR**

- Input: 80-140V/120-240V
- Output: 110/220V
- Frequency: 50-60Hz
- Delay Function



**ATVR-5000 (5000 VA)**  
**ATVR-8000 (8000 VA)**  
**ATVR-10000 (10000 VA)**  
**VOLTAGE REGULATOR**

- Input: 80-140V/120-240V
- Output: 110V/220V
- Frequency: 50/60Hz
- Delay Function



## ATVR-20000 (20000 VA)

### SINGLE PHASE VOLTAGE REGULATOR

#### TECHNICAL SPECIFICATIONS:

- Power: 20,000 VA
- Input: 80-260V AC
- Output: 110/220V ~
- Frequency: 50/60Hz
- Precision: ± 8%
- Delay Time: 6S/360S Selectable
- Available in Black or White

#### FEATURES:

- CRGO Transformer, LED Digital Display
- Servo Type, Single Phase
- High Voltage Protection
- Low Voltage Protection
- Overload Protection
- High Temperature Protection
- Short Circuit Protection



Front

**20K Watts**



Back



Top



Side

**DPWS-3012DS**

**30 AMP DC SWITCHING POWER SUPPLY**

- Input Voltage: 110AC, 60Hz
- Output Voltage: 13.8VDC, Adjusts Voltage between 9.0V and 15.0V
- Output Voltage Regulation: <2%
- Protection: Short-Circuit, Automatic Current Limiting Over 30A
- Output Current: 30A (Max) 20A (Continuous)
- Fuse: 8A
- Meter: Output Voltage and Current, Back-Lit
- Dimensions: 155 x 70 x 205mm
- Weight: Approx. 1.5Kg



**DPWS-5012DS**

**50 AMP DC SWITCHING POWER SUPPLY**

- Input Voltage: 110AC, 60Hz
- Output Voltage: 9.15VDC Regulated or 13.8V DC
- Output Voltage Regulation: <2%
- Protection: Short-Circuit, Automatic Current Limiting Over 50A
- Output Current: 50A (Max) 38A (Continuous)
- Fuse: 8A
- Meter: Single Volt/Current Meter, Back-Lit
- Dimensions: 195 x 85 x 280mm
- Weight: Approx. 1.5Kg



**TPS-946**

**SOLAR TRICKLE CHARGER**

- Helps to Manage Battery Drain for 12V Batteries
- Package: 12 Pcs/Carton (Foam + Color Inner Carton + Outer Carton)
- Outer Carton Size: 46.7 x 32.5 x 33cm
- Gross Weight: 22kg



### DSPS-10012V

#### 100 AMP DC SWITCHING POWER SUPPLY

- Output Voltage Range: 5-15V DC
- Output Current Range: 20-100A DC
- Protection: Short Circuit, Overload, Internal Over-Temperature, Surge, Input Under-Voltage
- Output Voltage Regulation: <1%
- Efficiency: >85%
- Low Ripple



### DVP-2712

#### DC POWER SUPPLY

- 25 Amp, 27 Amp Surge
- Converts to 13.8V DC
- Low Ripple
- Built-In Surge Protection



### DVP-712 (110V)

### DVP-220-712 (220V)

#### DC POWER SUPPLY

- 5 Amp, 7 Amp Surge
- Converts to 13.8V DC
- Low Ripple
- Built-In Surge Protection



### DVP-512LJ (5 Amp, 7 Amp Surge)

#### DC POWER SUPPLY WITH LIGHTER JACK

- Converts to 13.8V DC
- Low Ripple
- Built-In Surge Protection



### DVP-512 (110V)

### DVP-220-512 (220V)

#### DC POWER SUPPLY

- 3 Amp, 5 Amp Surge
- Converts to 13.8V DC
- Low Ripple
- Built-In Surge Protection



**DVP-515 (110V)**

**DC REGULATED POWER SUPPLY**

- 5 Amp Surge
- Converts to 1.5V-15V DC
- Low Ripple
- Built-In Surge Protection
- Voltage Adjustment Switch



**DVP-1212 (110V)**

**DVP-220-1212 (220V)**

**DC REGULATED POWER SUPPLY**

- 10 Amp, 12 Amp Surge
- Converts to 13.8V DC
- Low Ripple
- Built-In Surge Protection



**DVP-2212 (110V)**

**DVP-220-2212 (220V)**

**DC REGULATED POWER SUPPLY**

- DC Power Supply
- 20 Amp, 22 Amp Surge
- Converts to 13.8V DC
- Low Ripple
- Built-In Surge Protection



**DV-337CL**

**AC/DC ADAPTER WITH LIGHTER JACK**

- Input: 110V AC
- Output: 12V, 1A DC
- Compact Style
- Wall Mount



**DVP-305VR**

**VARIABLE DC POWER SUPPLY**

- Applicable for School, Small Hobbyist, Laboratory, Repair Center and more
- Provides a Circuit Overload Protection, Reverse Polarity Protection and Short Circuit Protection
- PCB Construction by SMD Adhesive Sheet Element Technology, Highly Reliable
- Fine and Coarse Adjustment of Regulated Current and Voltage Values from 0-30V and 0-5A for Multiple Uses
- Auto Cooling Fan Turns on when Temperature Reaches 50°C (115°F)
- All Metal Construction and Compact Design, Features Elegant Appearance and Power Saving
- Power: 150W
- Display: 3 Digits Green LED x 2 Set
- Display Error of Current:  $\pm 1.0\% + 2$  Digits
- Constant Voltage: Output Voltage: 0-30V Line Regulation: 0.01%+3mV Load Regulation: 0.01%+5mV Ripple Voltage: 1.0mV (RMS)
- Constant Current: Output Current: 0-5A Line Regulation: 0.2%+3mA Load Regulation: 0.2%+3mA Ripple Current: 3.0mA (RMS)
- Input Voltage: AC 110V  $\pm 10\%$ , 60Hz
- Weight: 11.7 lbs (5.3Kg)
- Dimensions: 11" x 5.4" x 6.3" (280 x 136 x 160mm)



**STEP UP & DOWN TRANSFORMER**

- TUD-100** (100 Watts)
- TUD-200** (200 Watts)
- TUD-300** (300 Watts)
- TUD-500** (500 Watts)
- TUD-1000** (1000 Watts)
- TUD-1500** (1500 Watts)
- TUD-2000** (2000 Watts)



**TRANSFORMER**

- One Socket
- Carrying Handle
- 2 Adapter Plug
- With Input Voltage Selector (110V/220V)
- No Grounding
- Removable Heads for Safety, in Order to Eliminate a Live Wire

- TUD-3000** (3000 Watts)
- TUD-5000** (5000 Watts)

**TRANSFORMER**



- Two Socket
- With Double Power Cord
- Carrying Handle
- No Grounding
- Removable Heads for Safety, in Order to Eliminate a Live Wire

This Series of Step Up/Down Voltage Transformers Offer you a Safe, Reliable, Affordable, and Convenient Solution to Converting Voltages from 110/120 Volts up to 220/240 Volts or from 220/240 Volts down to 110/120 Volts for both Home Use and Industrial Applications.

- TVS-100** (100 Watts)
- TVS-200** (200 Watts)
- TVS-300** (300 Watts)
- TVS-500** (500 Watts)
- TVS-1000** (1000 Watts)
- TVS-1500** (1500 Watts)
- TVS-2000** (2000 Watts)



**TRANSFORMER**

- One Socket
- Carrying Handle
- With Three-Prong Plugs
- With Input Voltage Selector (110V/220V)
- Two Free Spare Fuses
- With Grounding
- IEC Socket for Grounded Connection and Elimination of Live Wire

- TVS-3000** (3000 Watts)
- TVS-5000** (5000 Watts)

**TRANSFORMER**



- Two Socket
- With Double Power Cord
- Carrying Handle
- With Grounding
- IEC Socket for Grounded Connection and Elimination of Live Wire



**TUD-10000 (10,000 Watts)  
STEP UP & DOWN TRANSFORMER**

- 10000 step up and down transformer
- Two Socket
- With Double Power Cord
- Carrying Handle
- With Grounding



**TVS-10000 (10,000 Watts)  
STEP UP & DOWN TRANSFORMER**

- 10000 Step Up and Down Transformer
- Two Socket
- With Double Power Cord
- Carrying Handle
- With Grounding



**TC-AC-100  
REPLACEMENT AC CORD**

- Replacement AC cord for Nippon America transformers



**TCS-50U  
TRAVEL CONVERTER**

- Steps Up 110V/120V AC to 220V/240V
- 50W



**TC-70D  
VOLTAGE CONVERTER "DELUXE"**

- Steps Down 220V to 110V
- 50W



**TC-90  
INTERNATIONAL  
VOLTAGE CONVERTER**

- Input: AC 110V/220V or 220V/240V
- Output: AC 220V/240V or 110V/220V
- 60W



- LP-421** (6-0-6V, 0.3A)
- LP-423** (9-0-9V, 0.5A)
- LP-426** (6-0-6V, 0.5A)
- LP-427** (6-0-6V, 1A)
- LP-428** (6-0-6V, 2A)
- LP-430** (6-0-6V, 4A)
- LP-433** (9-0-9V, 1A)
- LP-435** (9-0-9V, 1.5A)
- LP-437** (9-0-9V, 2A)



**TRANSFORMER**

- Universal
- Center Taps
- 110V/220V
- 9-0-9V, 2A

- LP-520** (12-0-12V, 10A)
- LP-570** (12-0-12V, 0.5A)
- LP-573** (12-0-12V, 1A)
- LP-575** (12-0-12V, 2A)
- LP-577** (12-0-12V, 3A)
- LP-580** (12-0-12V, 4A)



**LINE MATCHING TRANSFORMER**

- Universal
- Center Taps
- 110V/220V
- 12-0-12V, 3A

**LP-578**

**SPEAKER LINE TRANSFORMER**

- 12-0-12V, 4A
- Universal
- Center Taps
- 110/220V



**LP-578-30**

**LINE TRANSFORMER**

- Simplifies Proper Installation of Multiple-Speaker PA System
- 30W



**DC12-2405**

**DC TO DC VOLTAGE TRANSFORMER**

- Input Voltage: DC 24V
- Output Voltage: DC 12V
- Maximum Current: 5A
- Fuse: 5A



**DC12-2415**

**DC TO DC VOLTAGE TRANSFORMER**

- Input Voltage: DC 24V
- Output Voltage: DC 12V
- Maximum Current: 15A
- Fuse: 15A



**DC12-2430**

**DC TO DC VOLTAGE TRANSFORMER**

- Input Voltage: DC 24V
- Output Voltage: DC 12V
- Maximum Current: 30A
- Fuse: 30A



**PIUB-3000-24X**
**24V DC TO 110V AC POWER INVERTER**

- Power: 3000W Max, 1500W RMS
- DC Input Voltage: 24V
- Fuse: 25A x 4
- Output Wave Form: Pure Sine Wave
- Output Voltage: 110V  $\pm$  5%
- Output Frequency: 60Hz  $\pm$  5%
- With DC Input Voltage Protection, Short Circuit Protection and Temperature Protection

**PSW-3000C**
**PURE SINE WAVE POWER INVERTER**

- Maximum Continuous Power: 1500W
- Peak Power: 3000W
- Input Voltage: 12V DC (10-15V)
- Output Voltage: 120V AC, 60Hz
- Waveform: Pure Sine Wave
- THD (Total Harmonic Distortion): Less than 4%
- USB Output: 5V DC, 2A Maximum
- Best Efficiency: >85%
- Protection: Overload, Over Voltage, Low Voltage, Over Temperature, Output Short
- Output Receptacle: Dual ETL Approval Sockets
- American Standard Receptacle
- Battery Connecting Cables: Red & Black 2 FT Length
- With ON/OFF Wire Remote Control Kit

**Cables Included**

**PSW-5000C**
**PURE SINE WAVE POWER INVERTER**

- Maximum Continuous Power: 2500W
- Peak Power: 5000W
- Input Voltage: 12V DC (10-15V)
- Output Voltage: 120V AC, 60Hz
- Waveform: Pure Sine Wave
- THD (Total Harmonic Distortion): Less than 4%
- USB Output: 5V DC, 2A Maximum
- Best Efficiency: >85%
- Protection: Overload, Over Voltage, Low Voltage, Over Temperature, Output Short
- Output Receptacle: Dual ETL Approval Sockets
- American Standard Receptacle
- Battery Connecting Cables: Red & Black 2 FT Length
- With ON/OFF Wire Remote Control Kit

**Cables Included**

## PI-200A

### POWER INVERTER

- Maximum Continuous Power: 200W
- Peak Load Power Rate: Up to 400W
- For Use with 12 Volt Systems
- No Load Current Draw: Up to 0.3 Amps
- Waveform: Modified Sine Wave
- Input DC Voltage Range: DC 11V-15V
- USB Output: 5V/2.4A
- Overload and Short-Circuit Protection
- (1) Replaceable 20 Amp Fuse
- Built-In Cooling Fan
- (2) 110V AC 3 Prong Grounded Receptacles
- Overload Indicator
- 14 AWG 24" Cigarette Plug Cable (Black) with Battery Clamp Included



## PI-400A

### POWER INVERTER

- Maximum Continuous Power: 200W
- Peak Load Power Rate: Up to 400W
- For Use with 12 Volt Systems
- No Load Current Draw: Up to 0.3 Amps
- Waveform: Modified Sine Wave
- Input DC Voltage Range: DC 11V-15V
- USB Output: 5V/2.4A
- Overload and Short-Circuit Protection
- (1) Replaceable 20 Amp Fuse
- Built-In Cooling Fan
- (2) 110V AC 3 Prong Grounded Receptacles
- Overload Indicator
- 14 AWG 24" Cigarette Plug Cable (Black) with Battery Clamp Included



## PIB-3000

### 12V DC TO 115V AC POWER INVERTER

- Input: 10.0~15.0V DC
- Power: 300W RMS, 600W Max
- Output: 110~120V AC
- Dual USB Output: 5V, 2A
- Output Frequency: 60Hz±2Hz
- Input Over Voltage Shutdown
- Input Under Voltage Warning
- Input Under Voltage Shutdown
- Input Fuse Protection
- Over Temperature Shutdown
- Output Short Circuit Protection
- Over Load Protection

**300  
Watts**
**POWER**

**PIB-5000**

**12V DC TO 115V AC POWER INVERTER**

- Input: 10.0~15.0V DC
- Power: 500W RMS, 1000W Max
- Output: 110~120V AC
- Dual USB Output: 5V, 2A
- Output Frequency: 60Hz±2Hz
- Input Over Voltage Shutdown
- Input Under Voltage Warning
- Input Under Voltage Shutdown
- Input Fuse Protection
- Over Temperature Shutdown
- Output Short Circuit Protection
- Over Load Protection



**PIB-7500**

**12V DC TO 115V AC POWER INVERTER**

- Input: 10.0~15.0V DC
- Power: 750W RMS, 1500W Max
- Output: 110~120V AC
- Dual USB Output: 5V, 2A
- Output Frequency: 60Hz±2Hz
- Input over Voltage Shutdown
- Input Under Voltage Warning
- Input Under Voltage Shutdown
- Input Fuse Protection
- Over Temperature Shutdown
- Output Short Circuit Protection
- Over Load Protection



**PIB-10000**

**12V DC TO 115V AC POWER INVERTER**

- Input: 10.0~15.0V DC
- Power: 1000W RMS, 2000W Max
- Output: 110~120V AC
- Dual USB Output: 5V, 2A
- Output Frequency: 60Hz±2Hz
- Input Over Voltage Shutdown
- Input Under Voltage Warning
- Input Under Voltage Shutdown
- Input Fuse Protection
- Over Temperature Shutdown
- Output Short Circuit Protection
- Over Load Protection



**PI-1000R**

**POWER INVERTER**

- Nominal input voltage: 12.8-13.2V DC
- Nominal output voltage: 115±10%V AC
- Output frequency: 60±3 Hz
- Operating input voltage: 10-15V DC
- Continuous output power: Up to 1000W
- Surge output power: 2000W
- Waveform: Modified sine wave
- Typical No Load Current (nominal input voltage): 0.4A DC
- Efficiency (typical): 85%
- Input overvoltage shutdown: 15.5±0.5V DC
- Input undervoltage alarm: 10.5±0.5V DC
- Input low voltage shutdown: 10.0±0.5V DC
- Output power overload shutdown level: 1300±300W
- Input fuse: 3 x 40A
- AC receptacles: Two, NEMA 5-15 USA
- USB port: Two, 5V/2A
- Battery cables: 8 AWG, 2 x 2'(60cm)



**Cables Included**



**12 Volt Voltage** / **5 Volt USB Output** / **1000 Watts Power**

**PI-1500R**

**POWER INVERTER**

- Nominal input voltage: 12.8-13.2V DC
- Nominal output voltage: 115±10%V AC
- Output frequency: 60±3 Hz
- Operating input voltage: 10-15V DC
- Continuous output power: Up to 1500W
- Surge output power: 3000W
- Waveform: Modified sine wave
- Typical No Load Current (at nominal input voltage): 0.5A DC
- Efficiency (typical): 85%
- Input overvoltage shutdown: 15.5±0.5V DC
- Input undervoltage alarm: 10.5±0.5V DC
- Input low voltage shutdown: 10.0±0.5V DC
- Output power overload shutdown level: 1800±300W
- Input fuse: 6 x 30A
- AC receptacles: Two, NEMA 5-15 USA
- USB port: Two, 5V/2A



**12 Volt Voltage** / **5 Volt USB Output** / **1500 Watts Power**

**PI-800C**

**POWER INVERTER**

- Max continuous power: 800W
- Peak load power rate: up to 1600W
- For use with 12V DC voltage systems
- No load current draw: up to 0.9 Amps
- Waveform: modified sine wave
- Input DC voltage range: 10V-15V DC
- USB Output: 5V/2.4A
- Overload and short-circuit protection
- (1) Replaceable 30 Amp fuse
- Built in cooling fan
- (2) 120V AC Volt 3 prong grounded American standard receptacles
- Overload indicator



**Cables Included**



Convert 24V DC from your car lighter socket to 120V AC outlet, ideal for use at campsites, road trips or anywhere dc to ac inverter is needed. Combine 2 AC outlets and 1 USB charging ports into one, ideal for charging up to 3 devices simultaneously. Built-in fuse & cooling fan, protection against short circuit, overload, overheat, low battery voltage and over battery voltage, will auto-resume after protection triggered.

**12 Volt**

**Voltage**

**5 Volt**

**USB Output**

**800 Watts**

**Power**

**PI-24110-400C**

**POWER INVERTER**

- Max continuous power: 400W
- Peak load power rate: up to 800W
- For use with 24V DC voltage systems
- No load current draw: up to 0.2 Amps
- Waveform: modified sine wave
- Input DC voltage range: 20V - 30V DC
- USB Output: 5V/2.4A
- Overload and short-circuit protection
- (1) Replaceable 20 Amp fuse
- Built-in cooling fan
- (2) 120V AC Volt 3 prong grounded American standard receptacles
- Overload indicator



**Cables Included**



Convert 24V DC from your car lighter socket to 120V AC outlet, ideal for use at campsites, road trips or anywhere dc to ac inverter is needed. Combine 2 AC outlets and 1 USB charging ports into one, ideal for charging up to 3 devices simultaneously. Built-in fuse & cooling fan, protection against short circuit, overload, overheat, low battery voltage and over battery voltage, will auto-resume after protection triggered.

**24 Volt**

**Voltage**

**5 Volt**

**USB Output**

**400 Watts**

**Power**

**PI-24110-800C**

**POWER INVERTER**

- Max continuous power: 800W
- Peak load power rate: up to 1600W
- For use with 24V DC voltage systems
- No load current draw: up to 0.4 Amps
- Waveform: modified sine wave
- Input DC voltage range: 20V - 30V DC
- USB Output: 5V/2.4A
- Overload and short-circuit protection
- (1) Replaceable 20 Amp fuse
- Built-in cooling fan
- (2) 120V AC Volt 3 prong grounded American standard receptacles
- Overload indicator



**Cables Included**



Convert 24V DC from your car lighter socket to 120V AC outlet, ideal for use at campsites, road trips or anywhere dc to ac inverter is needed. Combine 2 AC outlets and 1 USB charging ports into one, ideal for charging up to 3 devices simultaneously. Built-in fuse & cooling fan, protection against short circuit, overload, overheat, low battery voltage and over battery voltage, will auto-resume after protection triggered.

**24**  
Volt

**Voltage**

**5**  
Volt

**USB Output**

**800**  
Watts

**Power**

**PI-24110-2000C**

**POWER INVERTER**

- Max continuous power: 2000W
- Peak load power rate: up to 4000W
- For use with 24V DC voltage systems
- No load current draw: up to 0.5 Amps
- Waveform: modified sine wave
- Input DC voltage range: 20V - 30V DC
- USB Output: 5V/2.4A
- Overload and short-circuit protection
- (1) Replaceable 35 Amp fuse
- Built-in cooling fan
- (2) 120V AC Volt 3 prong grounded American standard receptacles
- Overload indicator



**Cables Included**



Convert 24V DC from your car lighter socket to 120V AC outlet, ideal for use at campsites, road trips or anywhere dc to ac inverter is needed. Combine 2 AC outlets and 1 USB charging ports into one, ideal for charging up to 3 devices simultaneously. Built-in fuse & cooling fan, protection against short circuit, overload, overheat, low battery voltage and over battery voltage, will auto-resume after protection triggered.

**24**  
Volt

**Voltage**

**5**  
Volt

**USB Output**

**2000**  
Watts

**Power**



**PI-DCDC-2412-10**
**24V DC TO 12V DC VOLTAGE CONVERTER**

- Output Power: 10Amp(Continuous) 15 Amp Max
- Standby Current: <0.02A
- Input Voltage: DC 20V~30V
- Output Voltage: DC 12V~13.8V
- Efficiency: >90%
- Cooling: By Air Convection
- Fuse: 10A x 1PC
- Dimensions(LxWxH): 110 x 87 x 42mm
- Net Weight: 0.45Kg

**PI-DCDC-2412-30**
**24V DC TO 12V DC VOLTAGE CONVERTER**

- Output Power: 30Amp(Continuous) 45 Amp Max
- Standby Current: <0.08A
- Input Voltage: DC 20V~30V
- Output Voltage: DC 12V~13.8V
- Efficiency: 85~90%
- Over Load: Circuit Protection
- Input Fuse: 30A
- Dimensions(LxWxH): 222 x 115 x 62mm
- Net Weight: 0.95Kg

**PI-DCDC2412-100**
**24V DC TO 12V DC VOLTAGE CONVERTER**

- Output Power: 100Amp(Continuous), 130Amp Max
- Standby Current: ≤1.10A
- Input Voltage: DC 20V~30V
- Output Voltage: DC 12V~13.8V
- Efficiency: 85~90%
- Thermal Protection: 65°C +/- 5°C
- Input Polarity Reverse: Diode Protection
- Output Polarity Reverse: Circuit Protection
- Output Short: Circuit Protection
- Over Heating: Circuit Protection
- Over Load: Circuit Protection
- Input Fuse: 4x30A
- Dimensions(L x W x H): 365 x 165 x 79mm
- Net Weight: 3.03Kg



## PI-DP-3000C

### 12V DC TO 110V AC POWER INVERTER

- Equivalent to standard household power
- Delivers high quality, clean power for superior performance
- Easy motor start-ups
- Reduced noise
- Reduced stress on circuitry
- Cost-effective
- High efficiency
- Light and portable
- Strong capability with most devices
- Not compatible with induction load devices such as medical equipment



Converts 12V DC battery power to 110V AC household electrical power. For use in cars, trucks, boats, and RVs.

## PIUB-2000-12X

### 12V DC TO 110V AC PURE SINE WAVE POWER INVERTER WITH BATTERY CHARGER

#### Invert Part:

- Output Wave: Pure Sine Wave
- Display: LCD
- Power: 1000W RMS, 2000W Max
- Input Voltage: DC 12V
- Output Voltage: AC 120V 60Hz
- Fuse: 35A x 4pcs Built-in
- USB: 5V x 2 (2.1A)

#### Charge Part:

- Input Voltage: AC 85V-135V 60Hz
- Output Charge Voltage: DC 14.5V
- Charge current: 25A MAX

#### Multiple protection:

- With Short-Circuit Protection
- Overload Protection
- Temperature Protection
- DC Input Low/Over Voltage Protection
- AC Input Low/Over Voltage Protection
- Anti-Polar Protection
- Fan Start Temperature:  $>45 \pm 5^\circ \text{C}$
- Lack-Voltage Alarm for DC Input



Included:

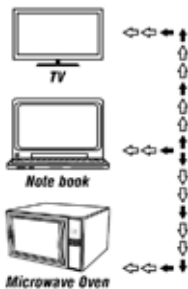

Front

Rear



**PIUB-3000-12X**

**12V DC TO 110V AC PURE SINE WAVE POWER INVERTER WITH BATTERY CHARGER**

**Invert Part:**

- Output Wave: Pure Sine Wave
- Display: LCD
- Power: 1500W RMS, 3000W Max
- Input Voltage: DC 12V
- Output Voltage: AC 120V 60Hz
- Fuse: 25A x 8pcs Built-in
- USB: 5V x 2 (2.1A)

**Charge Part:**

- Input Voltage: AC 85V-135V 60Hz
- Output Charge Voltage: DC 14.5V
- Charge current: 25A MAX

**Multiple protection:**

- With Short-Circuit Protection
- Overload Protection
- Temperature Protection
- DC Input Low/Over Voltage Protection
- AC Input Low/Over Voltage Protection
- Anti-Polar Protection
- Fan Start Temperature:  $>45 \pm 5^{\circ} \text{C}$
- Lack-Voltage Alarm for DC Input

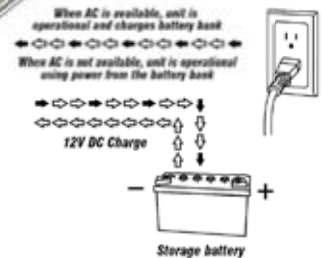

**Included:**

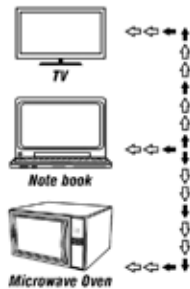

**Front**



**Rear**

**3000 Watts Power / Pure Sinewave Output**

**EX-ID216-6WHT**  
**EX-ID216-9WHT**  
**EX-ID216-12WHT**  
**EX-ID216-15WHT**  
**EX-ID216-20WHT**  
**EX-ID216-25WHT**

**FLAT PLUG EXTENSION CORD**

- 1625W, 16/2 SPT-2, 100% Copper
- Polarized for Convenient Use
- Safety Cover Permanently Attached



**EX-FLT316-6IVO**  
**EX-FLT316-12IVO**

**FLAT CABLE WITH FLAT PLUG EXTENSION CORD**

- SPT-3, 100% Copper, 16 Ga.
- 15 Amp, 127 Volt
- Heavy-Duty for Rugged Use Indoors & Outdoors
- Unbreakable Molded-On Connectors
- For Safe Operation with Power Tools, Work Lights, Small Appliances, and Electrical Motors in the Home, Office, Workshop, and Garage



**EX-OD314-25ORG**  
**EX-OD314-50ORG**  
**EX-OD314-100ORG**

**EXTENSION CORD WITH POWER INDICATOR**

- SJTW, 100% Copper, 14 Ga.
- 13 Amp, 300 Volt, 1625W
- Heavy-Duty for Rugged Use Indoors & Outdoors
- Unbreakable Molded-On Connectors
- For Safe Operation with Power Tools, Work Lights, Small Appliances, and Electrical Motors in the Home, Office, Workshop, and Garage



**EX-OD316-25ORG**  
**EX-OD316-50ORG**  
**EX-OD316-100ORG**

**EXTENSION CORD WITH POWER INDICATOR**

- SJTW, 100% Copper, 16 Ga.
- 13 Amp, 300 Volt, 1625W
- Heavy-Duty for Rugged Use Indoors & Outdoors
- Unbreakable Molded-On Connectors
- For Safe Operation with Power Tools, Work Lights, Small Appliances, and Electrical Motors in the Home, Office, Workshop, and Garage



**EX-PRO312-25BLK**  
**EX-PRO312-50BLK**

**3-OUTLET HEAVY DUTY EXTENSION CORD**

- Tangle-Free and Ultra-Flexible
- Great for Indoor/Outdoor Use Around the House, Garage and many other places
- 3 Grounded Outlets



15A/125V



25/7.6M



12 Gauge



15A/125V



50/15.2M



12 Gauge

**EX-PRO612N**

**3-OUTLET HEAVY DUTY EXTENSION CORD**

- Type: SJT 3 Conductor
- Connector A: NEMA 5-15 Power Plug (North America) Male
- Connector B: IEC 60320 C13 Power Plug (North America) Female+B7
- Wire Gauge: 16 AWG
- Amp Rating: 13A Max.
- Length: 12' (3.7M)

Works with most Amplifiers, DJ Cabinets and most Electronic Devices that Accommodate a 3-Pin Power Connector Ideal for use as a Replacement to an old or missing Power Cord or simply as a handy backup UL listed for Safety; Durable Design for Long-Lasting Strength and Performance.



**DVC-505**

**MULTI-OUTLET UNIVERSAL AC/DC ADAPTER**

- Current: 500mA
- Input: 110/220V
- Output: 1.5, 3, 4.5, 6, 7.5, 9, 12V
- 6 Detachable Output Plugs



**DVC-505-220**

**MULTI-OUTLET UNIVERSAL AC/DC ADAPTER**

- Current: 500mA
- Input: 220V
- Output: 1.5, 3, 4.5, 6, 7.5, 9, 12V
- 6 Detachable Output Plugs



**DVC-1005**

**MULTI-OUTLET UNIVERSAL AC/DC ADAPTER**

- Current: 100mA
- Input: 110/220V
- Output: 1.5, 3, 4.5, 6, 7.5, 9, 12V
- 6 Detachable Output Plugs



**DV-2000**

**UNIVERSAL AC/DC ADAPTER**

- Current: 2000mA
- Input: 110/220V
- Output: 3, 4.5, 6, 7.5, 9, 12, 15V
- Round Pin



**DV-3467**

**UNIVERSAL AC/DC ADAPTER**

- Current: 300mA
- Input: 110/220V
- Output: 3, 4.5, 6, 7.5, 9, 12V



**DV-5100A**

**UNIVERSAL AC/DC ADAPTER**

- Current: 500mA
- Input: 90/240V, 50/60Hz
- Output: 3, 4.5, 6, 7.5, 9, 12V
- Short Circuit Protection
- Thermal and Overload Cut-Off
- 6 Detachable Output Plugs



**DV-1500SQU**

**MULTI-OUTLET UNIVERSAL AC/DC ADAPTER**

- Input: 100V - 120V/ 200V - 240V AC 50 - 60Hz
- Output: 3, 5, 6, 7.5, 9, 12, 15V DC
- 1500mA Maximum



**J-236**

**DC POWER JACK**

- Jack 2.1mm x 5.5mm



**J-238**

**DC POWER JACK**

- DC Power Jack 2.5mm x 5.5mm



**AC-003RA**

**4FT AC POWER CORD WITH RIGHT ANGLE PLUGS**

- Allows Mounting of the TV Closer to the Wall so there is no Gap



**CCC-DC4**

**4 CONNECTOR CABLE**

- Compatible with: DVCA-24 DVCA548



**CCC-DC8**

**8 CONNECTOR CABLE**

- Compatible with: DVCA-24 DVCA548



**DVCA-24**

**AC ADAPTER**

- Input: AV 100~240V, 50/60Hz
- Output: DC 12V, 2A
- Power: 24W
- 2 A Output
- Connector Size: 5.5 x 2.5mm



**DVCA-548**

**AC TO DC ADAPTER**

- Input: AV 100~240V, 0.32~0.75A, 50/60Hz
- Output: DC 12V, 5A
- Power: 60W
- 5 A Output
- Connector Size: 5.5 x 2.5mm



**DV-5467**

**UNIVERSAL AC/DC ADAPTER**

- Current: 500mA
- Input: 110/220V
- Output: 3, 4.5, 6, 7.5, 9, 12, 15V
- Extra Plug for Walkman



**DV-1000**

**MULTI-OUTLET UNIVERSAL AC/DC ADAPTER**

- Current: 1000mA
- Input: 110/220V
- Output: 1.5, 3, 4.5, 6, 7.5, 9, 12V



**DV-CC-212**

**AC/DC ADAPTER**

- Input: AC 100~240V, 50/60Hz
- Output: 12V, 2A
- Used for CCTV



**DV-700MX**

**AC POWER ADAPTER**

- Current: 700mA
- Input: 120V, 60Hz
- Output: 18V



**DV-1012TV**

**AC POWER ADAPTER**

- Current: 1000mA
- Input: 120V, 60Hz
- Output: 12V
- Used for TV's



**DV-2300**

**SWITCHING POWER ADAPTOR FOR DIGITAL CAMERA**

- Input: 100-140V AC
- Output: 3V, 5V, 6V, 7.5V, 9V, 12V, DC
- Current: 0-2300mA
- Output Plug: with 6 Detachable Plugs



**DVK-3D**

**KEYBOARD AC/DC ADAPTER**

- Input: 100-240V, 50-60Hz
- Output: 12V
- Current: 1000mA
- Plug: 5mm



**Specially Designed for Keyboard Use**



**DVK-5D**

**KEYBOARD AC ADAPTER**

- Input: 120V, 50Hz
- Output: 12VDC
- Current: 1500mA
- Plug: 5mm



**DVD-12012CT**

**LEAD ACID BATTERY CHARGER (1.2A)**

- 110/200V, 50/60Hz AC, 6.0, 12V DC AT, ET, ST & RUK Input Plugs, Red & Black Battery Clip Output Plugs



**IS-CLE12**

**12V, 12' CIGARETTE EXTENSION CABLE**

- 12' Length
- Wire Gauge: 18 AWG
- 100% Copper Wire
- High Quality Molded Cable for Strength and Durability
- Male plug is fitted with a 15A fuse to protect your vehicle and devices and has LED light indication of power on

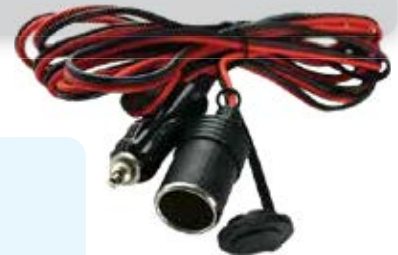

## DPSW-YA2A

### AC TO DC POWER ADAPTER

- Input: AC 100~240V, 50/60Hz, 0.8A
- Output: DC 12V, 2A
- Compatible with Yamaha Keyboards



For  
Keyboard Use



## DVSW-2000

### 2000MA SWITCHING

- Power Adapter
- Auto Voltage AC 90V-240V
- Output DC: 3-4.5-6-7.5-9-12V
- Output Current: 2000mA



## DVSW-2030SU

### 2100MA SWITCHING POWER ADAPTER

- Power: 30W
- Input Type: AC 100-240V 50-60HZ
- Output Type: DC3V/4.5V/5V/6V/7.5V/9V/12V
- USB PORT: 5.1V 2.1A
- DC Cable Length: 150cm
- DC Head Size: 2.5\*0.7, 3.0\*1.1, 3.5\*1.5, 5.0\*2.1, 5.5\*2.5, 3.5\*1.35mm with Addition Plug: Micro USB & LED



## DVSW-2500

### 2500MA SWITCHING

- Power Adapter
- Auto Voltage AC 90V-240V
- Output DC: 3-4.5-6-7.5-9-12V
- Output Current: 2500mA



## DV-117CL

### UNIVERSAL AC TO DC CAR CIGARETTE LIGHTER SOCKET ADAPTER

- Input: 90-240V, 56/60Hz
- Output: DC 12V, 500mA
- Turns any vehicle power charger into an AC travel charger
- Ultra slim design is lightweight and portable
- Safe for 110v or 220v outlets
- Useful with other travel items: air pumps, portable coolers, spotlights, laptop, PDA
- Compatible with any vehicle power charger so never becomes obsolete



## NP-112

### ADAPTER

- Cigarette lighter PLUG ADAPTER



## IPC-200

### IRON POWER CORD

- 6.5'
- Cotton, Brass
- Tinny Copper 99%





**NP-115**

**CIGARETTE LIGHTER PLUG**

- 1 F Jack



**NP-210**

**CIGARETTE LIGHTER PLUG**

- 2 F Jack



**AC-2380**

**FLAT PIN UNIVERSAL AC CHEATER CORDS**

- 6'
- For Tape Players



**AC-011**

**FLAT PIN UNIVERSAL AC CHEATER CORDS**

- 6'
- For Tape Players



**AC-2206**

**ROUND PIN UNIVERSAL AC CHEATER CORDS**

- 6'
- For Tape Players



**AC-D12**

**FLAT PIN FIGURE 8 AC POWER CORD**

- 6'
- Fits Panasonic, JVC, Sanyo & Fisher



**AC-003**

**MICKEY MOUSE TYPE GROUNDED AC CHEATER CORD**

- 6'
- Ideal for Laptops and Portable Projectors



**AC-006HQ**

**6' FLAT PIN UNIVERSAL AC CHEATER CORD FOR TAPE PLAYERS**

- 18 ga
- For Tape Players



**AC-088**

**A/C CORD**

- A/C cord with spade terminals



**CMC-200**

**APPLIANCE ELECTRICAL CORD**

- Connector made of ABS and Bakelite for Resistance to Extreme Heat
- Cable: 2\*38\*0.14 CCA
- OD: 3.8\*7.6
- 10A 250V
- 6FT



**F-21A**

**3 SECTION RADIO ANTENNA**

- 11" Knocked Down
- 30" Extended

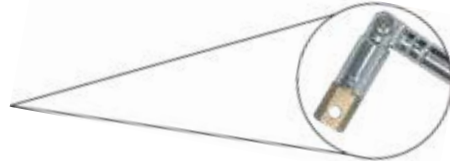

**F-21B**

**4 SECTION RADIO ANTENNA**

- 8" Knocked Down
- 24" Extended

**F-21C**

**4 SECTION RADIO ANTENNA**

- 11" Knocked Down
- 37" Extended

**DLPT-451**

**UNIVERSAL ULTRABOOK ADAPTER**

- Input: AC 100~240V, 50/60Hz
- Output: 19, 19.5, 20V, 45W max
- Compatible with Acer, Asus, Benq, Dell, Gateway, Hp, Lenovo, Samsung, Sony, Toshiba



Type / Tipo	Output / Salida	Connector Size / Tamaño del Conector	Laptop Brand / Marca del Ordenador Portatil
H1	19V/Max45W	5.5x3.0mm	For Samsung 19V, 2.1A
H2	19V/Max45W	4.0x1.35mm	For Asus 19V, 1.75A~2.37A
H3	19V/Max45W	5.5x2.5mm	For Toshiba/Benq/Gateway 19V, 1.58A/19V, 2.1A/19V, 2.37A
H5D	19.5V/Max45W	4.5x3.0mm	For Dell 19.5V 2.31A
H6	19.5V/Max45W	4.5x3.0mm	For Hp 19.5V 2.31A
H7	19V/Max45W	3.0x1.0mm	For Samsung 19V2.1A /For Asus 19V2.37A
H8	19V/Max45W	2.5x0.7mm	For Asus 19V, 1.58~2.1A
H10	19V/Max45W	5.5x1.7mm	For Acer 19V, 1.58~2.15A
H11	19.5V/Max45W	6.5x4.4mm	For Sony 19.5V 2A
H12	20V/Max45W	USB Type	For Lenovo 20V 2.25A

**DV-2005**

**AC/DC ADAPTER**

- Input: AC 100~240V, 50/60Hz
- Output: 5V, 2A
- Use for CCTV



**DVS-9V2A-5525**

**AC ADAPTER**

- Input: 100-240V, 1.5A, 50/60 Hz
- Output: 9V, 2A
- Power: 18W
- DC Connector: 5.5 x 2.5mm
- Power Cord Length: 6'/1.8m



**DVS-12V2A-5525**

**AC ADAPTER**

- Including one LED Terminal
- Input: 100-240V, 1.5A, 50/60 Hz
- Output: 12V, 2A
- Power: 24W
- DC Connector: 5.5 x 2.5mm
- Power Cord Length: 6'/1.8m



**DLPT-1015-LUB**

**SLIM UNIVERSAL AC ADAPTER**

- Input/Entrada: AC 100~240V, 50/60Hz
- Output/Salida: 15, 16, 18.5, 19, 19.5, 20V, 100W Max
- Compatible with/Compatible con: Acer, Asus, Dell, Hp, Lenovo, Samsung, Vivo, Toshiba

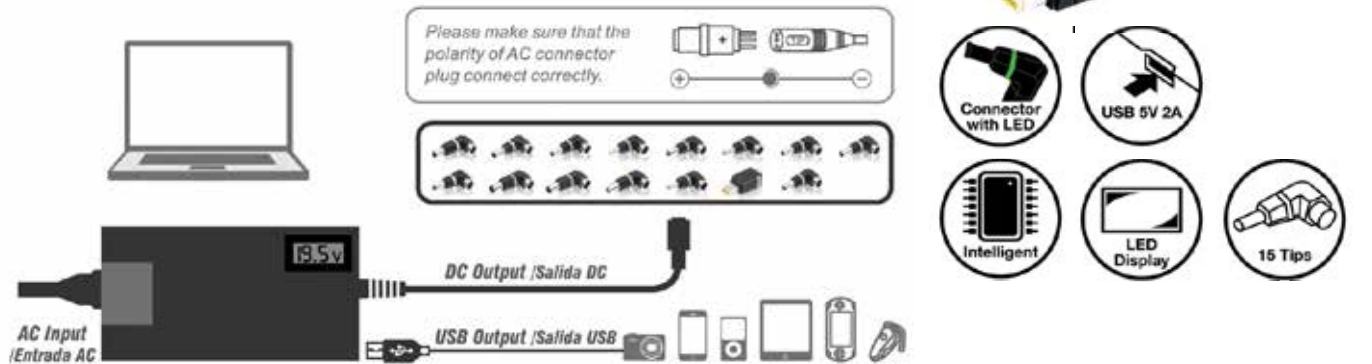

**DLPT-1208-USB**

**UNIVERSAL CAR AND HOME ADAPTER FOR LAPTOP**

- Input: DC12V; AC 110-240V
- Output: DC12-24V DC 4A USB 5V
- Full protection for notebook computers
- Simple change smart tips, compatible with different devices
- Choose the interchangeable smart tip according to the output voltage
- Works with: Notebook PCs of most brands and models
- Universal car adapter for laptop mobile phone mp3 mp4 digital camera

This Charger Provides up to 120 Watts of Power, and Included 8 Power Tips that are Compatible with Most Popular Laptops and Portable Devices:



**DLPT-UNI-24**

**AC ADAPTER**

- Input: 100~240V, 1.5A, 50/60Hz
- Output: 24V, 2.5A
- Power: 60W
- DC Connector: 5.5 x 2.1 mm
- DC Cable Length: 5.7' / 1.75 m
- 7 Tips



**DLPT-902USB**

**90W AUTOMATIC UNIVERSAL AC ADAPTER FOR LAPTOP**

- USB Port Charges for Smart Phone, MP3, MP4, iPad, iPhone, Tablet PC, PDA and other Related Devices with Standard USB Output
- Multiple Types of Interchangeable Connectors
- Safe and Reliable, Variable Voltages Range from 9.5V~24V
- Multi Country Ready (100V~240V)
- High Grade ABS Housing
- Fire Retardant Case
- Incorporates EMC and EMI Technology, for Absorbing Current Burst and Controlling the Circuitry



Type	Output	Connector Size	Laptop Brand
15.0V/M1	15.0V/Max x 90W	6.3 x 3.0mm	Toshiba
16.0V/M2	16.0V/Max x 90W	5.5 x 2.5mm	IBM, Lenovo
16.0V/M3	16.0V/Max x 90W	6.5 x 1.4mm	Sony, Fujitsu
18.5V/M4	18.0V/Max x 90W	4.8 x 1.7mm	Compaq, HP
19.0V/M5	19.0V/Max x 90W	5.5 x 2.5mm	Acer, Compaq, Delta, HP, Fujitsu, Gateway, Toshiba, Liteon
19.0V/M6	19.0V/Max x 90W	5.0 x 3.0mm	Samsung
19.0V/M7	19.0V/Max x 90W	5.5 x 2.1mm	Acer, Compaq, Delta, HP, Fujitsu, Gateway, Toshiba, Liteon
19.5V/M8	19.5V/Max x 90W	6.5 x 1.4mm	Sony
19.5V/M9	19.5V/Max x 90W	7.4 x 5.0mm	Dell
20.0V/M10	20.0V/Max x 90W	3 Pin Connector	Dell
20.0V/M11	20.0V/Max x 90W	7.9 x 5.4mm	IBM, Lenovo
18.5V/M12	18.5V/Max x 90W	7.4 x 5.0mm	HP, Compaq



**DLPT-909**

**AUTOMATIC UNIVERSAL AC ADAPTER**

- Input: AC 100 ~ 240V, 1.8A, 50/60Hz (Max)
- Output: DC 18.5V ~ 20V, 4.74A (Max)
- Power: 90W
- Charges for Laptop, Tablet, Smart Phone, Digital Camera, MP3, & MP4 Player
- Connector Size: 5.7" x 2.7" x 0.6" (144 x 69 x 16mm)



Type / Tipo	Output / Salida	Connector Size / Tamaño del Conector	Laptop Brand / Marca del Ordenador Portátil
H1	19V/Max 90W	5.5 x 3.0mm	Samsung: 19V/3.16A, 19V/4.22A, 19V/4.74A
H3	19V/Max 90W	5.5 x 2.5mm	Toshiba/Lenovo/Asus: 19V/3.42A, 19V/3.95A, 19V/4.74A 20V/3.25A, 20V/4.5A
H5D	19.5V/Max 90W	4.5 x 3.0mm	Dell: 19.5V/3.34A, 19.5V/4.62A
H6H	19.5V/Max 90W	4.5 x 3.0mm	HP: 19.5V/3.33A, 19.5V/4.62A
H10	19V/Max 90W	5.5 x 1.7mm	Acer: 19V/3.42A, 19V/3.95A, 19V/4.74A
H11	19.5V/Max 90W	6.5 x 4.4mm	Sony: 19.5V/3.33A, 19.5V/3.9A, 19.5V/4.7A
H12	20V/Max 90W	USB TYPE	IBM/Lenovo: 20V/3.25A, 20V/4.5A
H13D	19.5V/Max 90W	7.4 x 5.0mm	Dell: 19.5V/3.34A, 19.5V/4.62A
H14H	18.5V/Max 90W	7.4 x 5.0mm	HP: 18.5V/3.5A, 19.5V/3.33A, 19V/4.74A



Newly added connector covers latest HP models!



**DLPT-TYC-45**

**UNIVERSAL DEVICE TYPE C CHARGER**

- Input: 110V~240V, 50/60Hz, 1.1A
- Output: 5V/2A, 9V/2A, 12V/2A, 14.5V/2A, 15V/3A, 20V/2.25A
- Widely compatible with USB-C enabled smart phones, tablets, laptops and computers. Works with Macbook 2016, new Macbook Pro 2016, Dell XPS 13, HP Spectre and more USB-C laptops

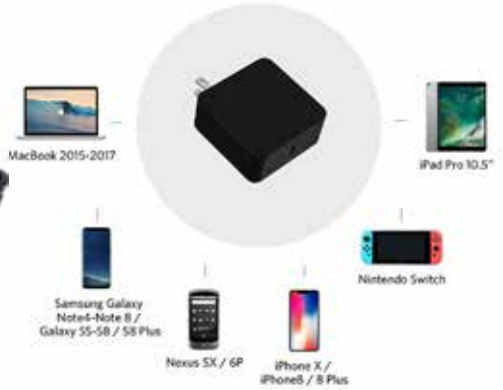

**45Watts Power**

**DLPT-UNI-16**

**SMART UNIVERSAL POWER ADAPTER**

- Input: 110V~240V, 50/60Hz, 1.5A
- Output: 5.25V, 3A



**16Watts Max**

Type/Tipo	Output/Salida	Connector Size/Tamaño del conector
A	5V/Max 16W	USB Type-C/USB Tipo-C
S	5V/Max 16W	Micro USB/USB Micro
C	5V/Max 16W	5.5 x 2.5mm
F	5V/Max 16W	4.8 x 1.7mm
G	5V/Max 16W	4.0 x 1.7mm
H	5V/Max 16W	3.5 x 1.35mm
I	5V/Max 16W	2.5 x 0.7mm
L	5V/Max 16W	3.0 x 1.0mm



**DLPT-UN50-24**

**AC ADAPTER**

- Input: 100~240V, 1.8A Max, 50/60Hz
- Output: 12-24V, 2A
- Power: 50W
- DC Cable Length: 3.9' / 1.2 m
- 8 Tips

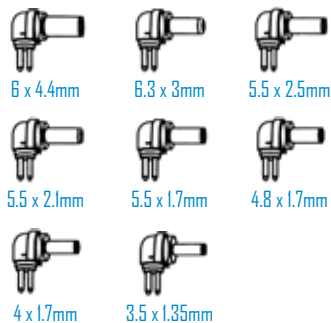

**Multi Voltage Switching**

**DLPT-12-CIG90**

**DC LAPTOP CHARGER**

- Input: 10-15V DC Max 8A
- Output: 19V/19.5V/20V 90W MAX
- New slim universal charger for laptop, tablet, or ultrabook
- Compatible with all the 30W-90W laptops, tablets, or ultrabooks
- With smart chip switching voltage, unique mould with LED light on the tips to indicate if the car charger is working

TIP#	Output Voltage (Voltage de Salida)	DC Connector (Conector DC)	Compatible Models / Modelos compatibles
K1	19-20V	7.9 x 5.5mm	IBM/LENOVO: 20V/3.25A, 20V/4.5A
K2M	18.5V-19.5V	7.4 x 5.0mm	HP: 18.5V/3.5A, 19.5V/3.33A, 19V/4.74A, 19.5V/4.62A
K3	19V-19.5V	6.5 x 4.4mm	LG/SAMY: 19V/1.3A, 19V/1.7A, 19.5V/2A, 19.5V/3.33A, 19.5V/3.8A, 19.5V/4.7A
K4	19V	5.5 x 3.0mm	SAMSUNG: 19V/2.1A, 19V/3.16A, 19V/4.22A, 19V/4.74A
K5	19-20V	5.5 x 2.5mm	ASUS/LENOVO/FUJITSU/ACER: 19V/3.16A, 19V/3.42A, 19V/3.95A, 19V/4.74A, 20V/3.25A, 20V/4.5A
K6	19V	5.5 x 1.7mm	ACER: 19V/1.58A, 19V/2.15A, 19V/2.37A, 19V/3.42A, 19V/4.74A
K9D	19.5V	4.5 x 2.0mm	DELL: 19V/2.37A, 19.5V/3.34A, 19.5V/4.62A
K10W	19.5V	4.5 x 3.0mm	HP: 19.5V/2.37A, 19.5V/3.33A, 19.5V/4.62A
K11	19V	4.0 x 1.25mm	ASUS: 19V/1.75A, 19V/2.37A, 19V/3.42A
K12	19-20V	4.0 x 1.7mm	TOSHIBA/LENOVO: 19V/2.37A, 20V/3.25A, 20V/4.5A
K13	19V	3.0 x 1.0mm	ASUS/SAMSUNG: 19V/2.1A, 19V/2.37A, 19V/3.16A, 19V/3.42A
K14	19V	2.5 x 0.7mm	ASUS: 19V/1.58A, 19V/2.1A
K15D	19.5V	7.4 x 5.0mm	DELL: 19V/2.37A, 19.5V/3.34A, 19.5V/4.62A
K16	19-20V	USB Type-C™ USB	IBM/LENOVO: 20V/3.25A, 20V/3.25A, 20V/4.5A
K17	18.5-19.5V	4.8 x 1.7mm	HP: 18.5V/3.5A, 19.5V/3.33A



**20-6450-3IU**

**POWER STRIP CHARGING CENTER FOR USB ELECTRONICS**

- AC Rating: 15A/125V/1875W
- Maximum Spike Voltage: 550V
- Clamping Voltage: 550V
- 450J Surge Suppressor to Protect Sensitive Electronic Equipment
- Length: 3'
- USB 2.1A + 1.0A
- For Indoor Use and Dry Locations
- Use for Portable Electronics, Video Game Console



**13-414**

**6 OUTLET AC POWER STRIP**

- High Impact, Fire-Retardant Plastic Housing
- Outlets: 6 "U" Ground
- Power Supply: 14AWG x 3C SJT
- Length: 3'
- Switch: Lighted Approach Switch
- Maximum Rating: 15A/120V AC/60Hz/1800 W
- 90 joules Surge Suppressor to Protect Sensitive Electronic Equipment
- For Indoor Use and Dry Locations



**13-6400**

**6 OUTLET AC POWER STRIP**

- High Impact, Fire-Retardant Plastic Housing
- Outlets: 6 "U" Ground
- Power Supply: 14AWG x 3C SJT
- Length: 2'
- Switch: Lighted Approach Switch
- Maximum Rating: 15A/120V AC/60Hz/1800 W
- 400 joules Surge Suppressor to Protect Sensitive Electronic Equipment
- For Indoor Use and Dry Locations



**16-516S**

**6 OUTLET WALL SOCKET**

- High Impact, Fire-Retardant Plastic Housing
- Outlets: 6 "U" Ground
- Max Rating: 15A / 125V AC/60Hz/1875W
- 1000 Joules Surge Suppressor to Protect Sensitive Electronic Equipment
- For Indoor Use Only and Dry Locations
- Can Swivel to Redirect Power and Safely Slide all your Furniture Back
- Creates Extra Space where you need it most



**1000  
Joules**

**15A, 125V, 60Hz & 1875W**



**17-81803U**

**8 OUTLETS AC POWER STRIP WITH TRIPLE USB PORTS**

- Suitable for General Electronics, Computers and Hi Fi Receivers

**INPUT:**

- Max Current: 15A
- Max Voltage: 125V
- Max Power: 1825W
- Nominal Voltage: 110V
- Nominal Frequency: 60Hz
- Resettable Circuit Breaker: 15A
- With ON/OFF Switch

**USB CHARGER:**

- Operating Temperature: <45°
- Operating Relative Humidity: <99%
- Storage Temperature: <45

**SURGE PROTECTION:**

- Energy Absorption: 1800 Joules
- Clamping Voltage: 400V
- Maximum Spike Current: 36000A

**USB CHARGER:**

- Allows you to charge iPhone/iPod and other mini appliance/iPhone/iPod
- Output: DC 5V/3.1A



**14-519**

**3 OUTLET SWIVELING GROUNDED WALL SOCKET**

- 110V
- Swiveling Design Ideal for Tight Spaces



**14-516**

**6 OUTLET GROUNDED WALL SOCKET**

- 110V
- Ideal for Home Offices



**14-509**

**3 OUTLET WALL SOCKET**

- 110V



**14-512**

**3 OUTLET GROUNDED WALL SOCKET**

- 110V
- Converts Single 3-Prong Outlet to Three 3-Prong Outlets



**PROTECT-E-RAE**

**REFRIGERATOR PROTECTOR WITH ETL APPROVAL**

**1200 WATT CAPACITY**

- Safety Range: AC 90-140V
- 50/60Hz Auto Sensing
- 4 States Indicator
- 15s / 30s / 180s Safety Cycle
- 350 degree rotation



**PROTECTX-AUD**

**APPLIANCE SURGE PROTECTOR**

**3000 WATT CAPACITY**

- For air conditioner, freezer, ice maker, and washing machine
- Over-voltage disconnection
- 4-minutes safety cycle
- 3 modes LED indicator
- Detachable ground pin

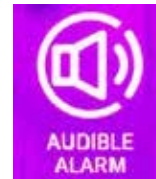

For Air Conditioners, Freezers, Ice Makers, Washing Machines or any Large Appliances. Protect your appliance from High or Low voltage by interrupting the current flow. Once the voltage returns to normal, the SAFETY CYCLE will light up for 4 minutes before it turns to green. After this period, the green light will turn on which will allow the current to flow.

**PROTECTX-AC**

**AIR CONDITIONER, FREEZER PROTECTOR**

- For Air Conditioner, Freezer, Ice Maker and Washing Machine
- Over-Voltage Disconnection
- 4-Minutes Safety Cycle
- 3 Modes LED Indicator
- Detachable Ground Pin



**PROTECTX-AC220**

**AIR CONDITIONER, FREEZER PROTECTOR WITH ANTI SURGE**

- For Air Conditioner, Freezer, Ice Maker and Washing Machine
- Over-Voltage Disconnection
- 4-Minutes Safety Cycle
- 3 Modes LED Indicator
- Detachable Ground Pin





**PROTECTX-ELE**

**GENERAL ELECTRONIC PROTECTOR WITH ANTI SURGE**

- For TVs, Video Games, Computers and Audio Systems
- High and Low Voltage Disconnection
- 10-Seconds Safety Cycle
- 3 Modes LED Indicator
- Detachable Ground Pin
- Capacity: 900W
- Safety Cycle: About 10 Seconds
- Working Voltage: AC 115V
- Safety Range: AC 85-135V



**PROTECTX-J-45**

**VOLTAGE PROTECTOR WITH ANTI SURGE**

- For TVs, Video Games, Printers, Computers, Routers, Modems and Audio Systems
- High & Low Voltage Disconnection
- With On/Off Switch
- 15/30/180 Seconds Safety Cycle can be Chosen
- 3 Modes LED Indicator



**PROTECTX-RF**

**REFRIGERATOR PROTECTOR**

- For All Types of Domestic Refrigerators
- Over-Voltage Disconnection
- 4-Minutes Safety Cycle
- 3 Modes LED Indicator
- Detachable Ground Pin



**PROTECT-J-E2**

**GENERAL ELECTRONIC PROTECTOR WITH ANTI SURGE**

- 10-Seconds Security Cycle
- High and Low Voltage Disconnection
- 5 Modes LED Indicator
- Detachable Ground Pin
- Ideal to protect: TV, Video Games, Microwave Ovens, Computers & Audio System
- With Grounded Indicator and Surge Indicator
- Double Outlets
- Capacity: 1800, 2HP
- Safety Cycle: 10 Seconds
- Input: AC 115V 60Hz, 15A
- Surge Protection Max: 12000A



**PROTECTX-612J**

**6 OUTLETS SURGE PROTECTOR**

- Rating: AC 125V/15A or AC 220V/10A 60HZ
- 1875W
- 3 FT. Heavy Duty Cord, 18 AWG.
- 100% Copper
- Surge Spike Protection
- ON/OFF Rocker Switch
- For Indoor Use Only and Dry Locations



**PROTECT-D-ELEC2**

**GENERAL ELECTRONIC PROTECTOR**

- For TV's, Video Game Systems, Microwave Ovens, Computers and Audio Systems
- Protects against Problems Originating in the AC Electric Line
- High and Low Voltage Disconnection: Low 90V, High 130V
- 10-Second Safety Cycle
- 1800 Watts
- Input: AC 115V, 60Hz, 15A
- AC 110V
- 2 Outlets



**PROTECT-I208E**

**AUTOMATIC VOLTAGE REGULATOR**

- For TV's, Video Game Systems, Microwave Ovens, Computers and Audio Systems
- Protects against Problems originating in the AC Electric Line
- High and Low Voltage Disconnection: Low 86V, High 138V
- Safety Cycle Switch with 3 Settings: 2 Seconds, 10 Seconds and 30 Seconds
- 600 Watts
- Input: 115V, 50/60 Hz Auto-Sensing
- LED Status Indicator for Boost, Overheat and Buck
- 8 Outlets



**PROTECT-TE220**

**VOLTAGE PROTECTOR**

- Working Voltage: 220V AC
- 50/60Hz Auto Sensing
- Under Voltage: 170V, 180V, 190V
- Over Voltage: 240V, 250V, 260V
- Working Current: 30A
- Delay Time: 5 - 180 seconds (adjustable)
- Over Voltage Protection
- Under Voltage Protection
- Protect your appliance from HIGH voltage or LOW Voltage by interrupting the current flow.



Primarily for use with 220v wall/split type ac units

**P-523**

**UNIVERSAL TRAVEL ADAPTER**

The Universal Adaptor is a Compact One Piece Unit with 4 International Adaptors, and Provide a Child Protection Safety Shutter, Power Indicator Light and Surge Protector.

This Item will Fit the Plugs in Europe/UK/USA/China/Japan/Australia/Spain and almost every Country in the World

- Sold Individually



**P-525DUSB**

**UNIVERSAL TRAVEL ADAPTER**

The Universal Adaptor is a Compact One Piece Unit with 4 International Adaptors, and Provide a Child Protection Safety Shutter, Power Indicator Light and Surge Protector.

This Item will Fit the Plugs in Europe/UK/USA/China/Japan/Australia/Spain and almost every Country in the World. The USB Charge is 5Vdc 1000mA

- Sold Individually



**AC-282M**

**ADAPTER**

- Male 3 PIN AC extension plug or jack panel mount



**P-510**

**ADAPTER**

- Flat pin plug to round pin socket



**P-510D**

**ADAPTER**

- Deluxe flat pin plug to round pin socket



**P-510D-C**

**ADAPTER**

- Input: 110-220V
- Output: 10A 250V
- Copper Connectors



**P-513**

**ADAPTER**

- Round pin plug to flat pin socket



**P-514**

**3-PRONG PLUG TO 2-PRONG OUTLET**

- Permits "U" Ground
- Orange Color



**P-514G**

**3-PRONG PLUG TO 2-PRONG OUTLET**

- Permits "U" Ground
- Grey Color



**FOREIGN PLUG ADAPTER**

**P-517**

**MULTI-ADAPTER**

- Adapts American Outlets to Most Foreign Plugs



**P-519**

**MULTI-ADAPTER**

- European Adapter



**P-521**

**FLAT PIN TO MULTI-PLUG ADAPTER**

- Adapts American Outlets to Most Foreign Plugs



**P-522**

**ROUND PIN TO MULTI-PLUG ADAPTER**

- Adapts American Outlets to Most Foreign Plugs



**P-521BL**

**FLAT PIN TO MULTI-PLUG ADAPTER**

- This travel adapter is used to adapt American outlets to most foreign plugs.
- MAX 10A 250V



**P-522BL**

**ROUND PIN TO MULTI-PLUG ADAPTER**

- This adapter permits plugs from other countries to fit into the Euro/Asian Style Electric Wall Outlet. This plug is used in Continental Europe and many countries in Asia.
- MAX 10A 250V
- Color: Ivory.



**P-523BL**

**UNIVERSAL TRAVEL ADAPTER**

- This Universal adaptor is a compact one-piece unit with 4 international adaptors, and provide a child protection safety shutter, power indicator light and surge protectors. It offers worldwide compatibility and covers more than 150 countries, including: Australia; New Zealand; USA; China; Japan; Thailand; India; Europe; UK; Hong Kong; Malaysia and Singapore.
- Electrical rating: 125V 6A / 250V 13A.



Europe, India.



UK, Hong Kong, Malaysia, Singapore.



US, China, Japan, Thailand.



Australia, New Zealand.



**AC-006**

**FLAT PIN UNIVERSAL AC CHEATER CORDS**



- 6'
- For Tape Players

**AC-010**

**FLAT PIN UNIVERSAL AC CHEATER CORDS**



- 6'
- For Tape Players

**AC-282M**

**ADAPTER**

- Male 3 PIN AC extension plug or jack panel mount



**P-510**

**ADAPTER**

- Flat pin plug to round pin socket



**P-510D**

**ADAPTER**

- Deluxe flat pin plug to round pin socket



**P-510D-C**

**ADAPTER**

- Input: 110-220V
- Output: 10A 250V
- Copper Connectors



**P-513**

**ADAPTER**

- Round pin plug to flat pin socket



**P-514**

**3-PRONG PLUG TO 2-PRONG OUTLET**

- Permits "U" Ground
- Orange Color



**P-514G**

**3-PRONG PLUG TO 2-PRONG OUTLET**

- Permits "U" Ground
- Grey Color



**LBCH-12M**

**DOUBLE INSULATED**

- Thermal Overload Safety
- Electronic LED Display
- CE Approved
- For 12V Car, Motorcycle & Lawnmower Batteries
- 6/12V, 12 Amp



**LBCH-612SW**

**6/12V, 6 AMP**

- Blade Type Fuse
- Overload Protection



**LBCH-6M**

**DOUBLE INSULATED**

- Power Supply
- Thermal Overload Safety
- Electronic LED Display
- CE Approved
- For 12V Car, Motorcycle & Lawnmower Batteries
- 6/12V, 6 Amp



**LBCH-80M**

**THERMAL OVERLOAD SAFETY**

- Electronic LED Display
- CE Approved
- For 12V Car, Motorcycle & Lawnmower Batteries
- 12V, 20 Amp



**LBCP-12-6**

**BATTERY CHARGER**

- Input voltage: AC 115V/60Hz
- Rated Power: 103W
- Output Voltage: 12V DC
- Rated Current: 4.2A
- Peak Current: 6A
- Battery Types: 12V DC (Lead-acid battery)
- Battery Capacity: 14-84Ah
- Plastic shell
- Overheating protection
- Short circuit protection

**12 Volt - 6 AMP**



**EX-JUMP4-20**

**BOOSTER CABLES**

- 4Ga, 20FT
- Tangle-Free Construction
- Phase Marked Clamps for Added Safety
- High/Low Temperature Construction
- Extra Flexible for Easy Use



**EX-JUMP6-16**

**BOOSTER CABLES**

- 6Ga, 16FT
- Tangle-Free Construction
- Phase Marked Clamps for Added Safety
- High/Low Temperature Construction
- Extra Flexible for Easy Use



**NB-2**

**BATTERY SNAPS**

- 9-volt battery snaps with wire leads



**NB-480**

**BATTERY CLIP**

- 2 battery clips to cigarette lighter jack



**NB-440 BLK**

**BATTERY CLIP**

- Black 30A Battery Clip



**NB-440 RED**

**BATTERY CLIP**

- Red 30A Battery Clip



**NB-550 BLK (Black)**

**NB-550 RED (Red)**

**BATTERY CLIP**

- 50 AMP Battery Clip Available in Black and Red



**NB-660 BLK (Black)**

**NB-660 RED (Red)**

**BATTERY CLIP**

- 60 AMP Battery Clip Available in Black and Red



**NB-770**

**BATTERY JUMPER CABLE**

- 70 amp Battery Jumper Cable Available in Black and Red



**NB-880**

**BATTERY JUMPER CABLE**

- 80 amp Battery Jumper Cable Available in Black and Red



**EL-536USV**

**RECHARGEABLE EMERGENCY LANTERN**

- Light Source: 36 x 0.5W LED
- Solar Panel Charger
- USB 5V Mobile Phone Charger
- DC 12V Input
- 360° Light Distribution
- Power Source: 110-220V / 60Hz
- Battery: 4V 6Ah Sealed Lead-Acid Rechargeable Battery
- Charge Time: 20-24 Hours
- Duration: 8-10 Hours/Strong Light; >25 Hours/Weak Light
- Dimension: 145 x 145 x 300mm (5.7" x 5.7" x 11.8")

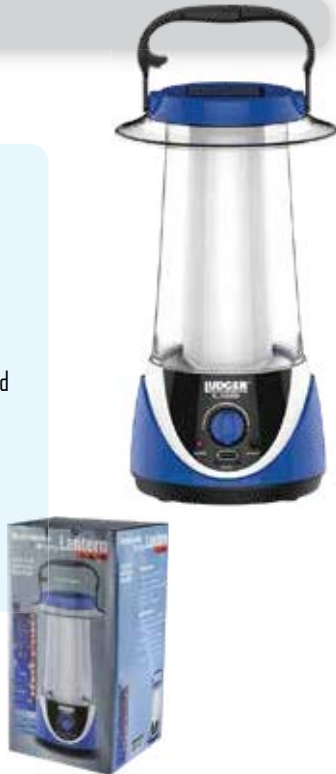

**EL-7005L**

**RECHARGEABLE HANDY LIGHT**

- AC Power: 110-220V
- Charging Time: Approx. 12-15 Hours
- Duration Time: Approx 4 Hours
- Rechargeable Battery: 4V 0.4AH Sealed Lead-Acid Rechargeable Battery
- LED: 5x1500MCD, 110 Degree Bright LED Torch



**EL-8003L**

**RECHARGEABLE HANDY LIGHT**

- 4V 3Ah Rechargeable Lead-Acid Battery
- 12 x 1500MCD
- 110° Bright LED



**EL-1830LED (W/ CAR ADAPTER)**

**RECHARGEABLE EMERGENCY LED LANTERN**

- Light: 26 Pcs 0.5W LED x 2 Tubes
- FM Scan Radio
- Overcharge Protection
- 360° Degrees Light Distribution
- AC Power: 110-220V / 60Hz
- Charging Time: Approx. 20-24 Hours
- Working Time: 1 Tube: 5 Hours  
2 Tubes: 2.5 Hours  
Radio: 18 Hours
- 4V 4000mAh Rechargeable Lead Acid Battery



**AUTO VOLTAGE 110-220V**  
Input Capacity

**360° LIGHT DISTRIBUTION**  
360° de Distribución de luz

**FM SCAN RADIO**  
Radio FM



**EL-8212F**

**12" RECHARGEABLE FAN**

- Input Voltage: 110-240V, 50/60Hz
- Maximum Power: 22W
- Rated Current: 1.3A
- AC/DC Operate
- 6V 4.5 Ah Rechargeable Lead Acid Battery
- 12 Inch Oscillating 2-Speed Fan
- Over Charge & Discharge Protection
- With New ABS Material
- 1.5M 2 Pin Flat Plug
- 8 Pcs Super Bright LED
- With DC Input and USB Output
- Charging Time: 8-12 Hours
- Working Time:
  - High Speed: 3 Hours
  - Low Speed: 5 Hours
  - LED: 30 Hours



**USB 5V Output**  
for Cellular or Accessory charging



**EL-8210F**

**10" RECHARGEABLE FAN**

- Input Voltage: 110-240V, 50/60Hz
- Max. Power: 17W
- Rated Current: 1.3A
- AC/DC Operational
- 6V 4.5 Ah Rechargeable Lead Acid Battery
- 10 Inch 2-Speed Fan
- Over Charge & Discharge Protection
- With New PP Material
- 1.5M 2 Pin Flat Plug
- 4 Pcs Super Bright LED
- With DC Input and USB Output
- FM Radio with Scan Function
- Charging Time: 10-15 Hours
- Working Time:
  - High Speed: 3 Hours
  - Low Speed: 4.5 Hours
  - LED: 90 Hours
  - Radio: 15 Hours



**USB 5V Output**  
for Cellular or Accessory charging



**RMQT-301**

**ELECTRO SWAT**

- It is Safe for Indoor or Outdoor Use, Convenient Hygienic Insect Terminator
- Comes in Red, Yellow, Blue and Green

This Product Requires 2 AA 1.5V Batteries (Not Included). The Electro Swat Emits No Smell, Uses No Poisonous or Harmful Material.



**EL-3360L**

**RECHARGEABLE BRIGHT LED EMERGENCY LIGHT**

- AC Power: 110/220V
- Charging Time: Approx. 20-24 Hours
- Duration Time:
  - Approx. 22 Hours (1 Line), Approx. 12 Hours (2 Lines), Approx. 8 Hours (3 Lines)
- Rechargeable Battery: 4V/2.8Ah Sealed Lead-Acid



**NL-102**

**LED NIGHT LIGHT**

- Input: 120V AC, 60Hz
- Power Consumption: 0.5W
- Lifespan: Up to 50,000 Hours
- Sensor Mode: <10 Lux Light On, >10 Lux Light Off
- IP Classify: IP 20, Indoor Use Only
- Dawn to Dusk Sensor so Light Only Activates in Darkness
- Bright White LED Provides Nice Warm Light Output
- No Bulb Replacement with Energy Efficient LEDs
- Perfect for Bathrooms, Bedrooms and Anywhere you need some Extra Light



**AT-324L**

**EMERGENCY LIGHT**

- Input voltage: AC100~240V
- Lighting source: SMD LED 16+16PCS
- Luminous flux: 600 lm
- Brightness: >15 cd/m<sup>2</sup>
- Beam angle: 120°
- Case material: ABS
- Work temperature: 0~50°
- Operation: 3 Hr
- AC Power consumption: 4 W
- Battery: Lead-Acid 4V 2.4A
- Charging time: 48 Hr
- Dimensions: 195(L)x52(W)x176.5(H) mm
- Net weight: 670 g
- One piece packing: 223x58x191 mm

**Voltage  
100V - 240V**

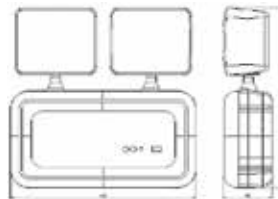

**AT-446WL**

**EMERGENCY LIGHT**

- Input voltage: AC100~240V
- Lighting source: SMD LED 22+22PCS
- Luminous flux: 220 lm
- Brightness: >15 cd/m<sup>2</sup>
- Beam angle: 120°
- Case material: ABS
- Work temperature: 0~50°
- Operation: 12 Hr
- AC Power consumption: 4 W
- Battery: Lead-Acid 6V 4A
- Charging time: 48 Hr
- Dimensions: 300x130.4x76.8 mm
- Net weight: 1170 g
- One piece packing: 310x137x80.5 mm

**Voltage  
100V - 240V**

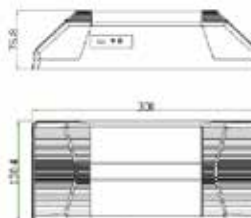

**GR-507D**

**GAS REGULATOR**

- Inlet Pressure: 1530~30Kpa
- Outlet Pressure: 2.75k±0.499Kpa
- Gas Flow: 0.6m<sup>3</sup>/h
- Lock Up Pressure: ≤3.43Kpa



**GRG-669**

**GAS REGULATOR**

- Has a Level Indicator
- Inlet Pressure: 1530-30Kpa
- Outlet Pressure: 2.75k±0.499Kpa
- Gas Flow: 0.6m<sup>3</sup>/h
- Lock Up Pressure: <3.43Kpa



**GR-707**

**GAS REGULATOR**

- Inlet Pressure: 1530-30Kpa
- Outlet Pressure: 2.75k±0.499Kpa
- Gas Flow: 0.6m<sup>3</sup>/h
- Lock Up Pressure: <3.43Kpa



**EWBL-113-2U**

**65W ENERGY SAVING LIGHT BULB**

- 13W Consumption
- Daylight Color
- 110V



**EWBL-115-T3**

**75W ENERGY SAVING LIGHT BULB**

- 15W Consumption
- Daylight Color
- 110V



**AC-E27**

**BULB SOCKET**

- More Lighting - Add a light where lamp sockets are limited with the NA Polarized Socket Adapter
- Adapter - This adapter converts a 2-prong outlet into a lamp socket in seconds
- Indoor Use Only - Great for your workshop, garage or utility room that might need extra lighting
- Easy to Install - Just plug in the adapter into an outlet, and screw in a standard, medium-based bulb to start using
- Power - Do not exceed the electrical rating of 125VAC and 660W



**EWSL-125-T3**

**25W ENERGY SAVING SPOT LIGHT**

- 110-120V/50-60Hz
- Color Temperature: 6400K
- Lumens: 1150
- Life: 8000 Hrs.
- Base: E27



**EL-1812SF**

**18" RECHARGEABLE FAN WITH EMERGENCY LIGHT**

- Input Voltage: 120 ~ 240 AC, 50/60Hz
- Rated current: 1.6A
- Fan Size: 18 inches
- Multi-angle Tilting AC/DC Powerful 3-speed Oscillating Fan
- 6pcs LED night light
- Battery 12V 7Ah Lead-Acid Battery
- With Remote Control: Dry Battery: AAAx2 (Not Included)
- Charge time: 8 ~ 12 Hours  
LED: 8 Hours
- Duration time:  
High Speed: About 3.5 Hours  
Middle Speed: About 6.5 Hours  
Low Speed: About 18 Hours  
LED: 8 Hours
- Product Size (LxWxH): 498x395x (1048 ~ 1349) mm  
19.6"x15.6"x (41.3" ~ 53.1")



**EL-44980L**

**RECHARGEABLE EMERGENCY LIGHT**

- AC 120V/DC 6V dual power system, it can be used and charged anywhere
- Emergency & Automatic light-up
- Automatically turns on if there is a power failure
- Also operate as standard line powered led light
- Mountable on the wall, portable with built-in handle and stand
- With new ABS material
- Pull switch
- Over charge protection
- With bracket
- Power source: 110~240V AC, 50/60Hz
- Power: 6 Watts
- Battery: 6v 2.8Ah rechargeable sealed lead acid battery
- 90 pcs super bright LED
- Color temperature: 8000K
- Charging time: approximately 12~15 hours depending on depth of discharge
- Operating time: 7 hours for 90 LEDs



**EL-8205RF**

**RECHARGEABLE FAN WITH EMERGENCY LIGHT AND AM/FM RADIO**

- Energy saving with LED light and radio
- Easy to carry
- Oscillating 2-speed fan
- Battery overcharge and over discharge protection function
- Electric transformer
- Power source: 110~240 AC, 50/60Hz
- Power: 15 Watts
- Battery: 6V 2Ah lead-acid battery
- Light source: 24 x 0.2W SMD LED
- Charge time: 8 hours
- Duration time:  
FAN: 2.5 hours (high speed) 4.5 hours (low speed)
- LED: 8 hours
- Radio: 8 hours
- Product size: 194 x 102 x 273 mm (7.6" x 4" x 10.7")



**ELV-2036**

**UV GERMICIDAL LAMP**

- 360° all-around UV Sterilization.
- Effective Area:  $\leq 40m^2$ .
- 99.9% powerful sterilization and disinfection.
- Effectively kills the New Coronavirus COVID-19.
- 3 duration options for timed operating (15min/30min/60min).
- UV tube: 36W.
- Standby power: Max 2W.
- Rated power: Max 40W.
- Input power supply: 110-120V, 50/60Hz.

**UV Sterilization Effect:**

- Escherichia Coli Kills 99.40%
- Staphylococcus Kills 99.39%
- Streptococcus Kills 99.06%
- Aspergillus Niger Kills 96.85%
- Mucor Kills 87.00%
- Penicillium Kills 98.80%

**UV Sterilization Applications:**

- For Home, Office, Restaurants and Retail Stores

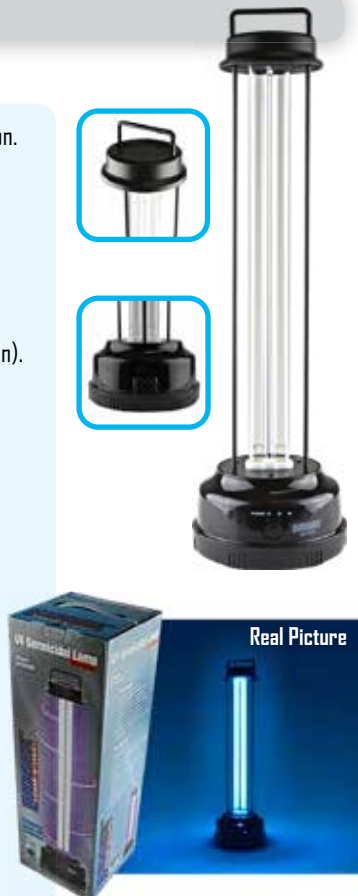

HOME SECURITY

2022 CATALOG



- CCCBL-25** (25')
- CCCBL-50** (50')
- CCCBL-75** (75')
- CCCBL-100** (100')
- CCCBL-150** (150')
- CCCBL-250** (250')
- CCCB-500** (500')
- CCCB-1000BL** (1000')



**CLOSED CIRCUIT TELEVISION  
EXTENSION CABLE**

- RG-6 Siamese Cable
- Solid Copper Conductor for Less Voltage Drop and Better Signal Over Longer Distances
- All in One Video and Power Cable
- Plug and Plug Ready
- Cable Functions for BNC or RCA Connection
- BNC Male Connections On Video Cable
- Male Jack, Plug Female On DC Power Cable
- Double Shielded with Aluminum Foil Insulation and Braiding
- Different Adaptors to Connect Lengths of Cable Together or to Connect to An RCA Jack

**HMA-KT-4**

**WIRELESS EXPANDABLE  
HOME ALARM**

- Box Contents:
  - 1 x Alarm Unit
  - 1 x Door/Window Sensor Magnets
  - 1 x Motion Detector
  - 1 x AAA LR03 Batteries, Alkaline
  - 1 x Remote Control
- Main Unit can Add Maximum 10 Remote Controllers
- Main Unit with 4 Zones, Each Zone can Add Maximum 10 Detectors



**Main Unit**

**PIR Motion  
Sensor**

**Window/Door  
Sensor**

**Remote  
Control**

**CC-TERM12SK**

**CCTV 12V TERMINAL JACK**

- Female DC Jack Connector Plug for CCTV Security Camera
- No more Cutting and Soldering
- Simply Screw your Cable and just Plug it in CCTV -DC JACK w/SCREW 2.1 X 5



**CC-TERM12**

**CCCTV -DC PLUG**

- Male DC Jack Connector Plug for CCTV Security Camera
- No more Cutting and Soldering
- Simply Screw your Cable and just Plug it in CCCTV -DC JACK w/SCREW 2.1 X 5



## CC-TERMBNCF

### CCCTV-BNC JACK

- Female BNC Jack Connector Plug for CCTV Security Camera
- No more Cutting and Soldering
- Simply Screw your Cable and just Plug it in



## CC-SR250

### HD-CVI/TVI/AHD/CVB PASSIVE VIDEO BALUN

- Compatible with all HD-CVI, HD-TVI, HD-AHD
- Up to 450m for 720P CVI Cameras
- NTSC, PAL, and SECAM Video Formats
- No Power Required
- 60dB Cross Talk and Noise Immunity



## CC-VB2000CB

### 1 CHANNEL PASSIVE VIDEO TRANSCEIVER WITH CABLE

- Video Transmission Via UTP CAT5 Cable
- 10%~20% Wire Costs Saved
- Full-Motion CCTV Video at Distances up to 2000' (600M)
- Outstanding Interference Rejection and Transient Protection



## CC-VB2000RA

### 1 CHANNEL RIGHT ANGLE PASSIVE VIDEO TRANSCEIVER

- Video Transmission Via UTP CAT5 Cable
- 10%~20% Wire Costs Saved
- Full-Motion CCTV Video at Distances up to 2000' (600M)
- Outstanding Interference Rejection and Transient Protection



## CC-VB2000T

### 1 CHANNEL PASSIVE VIDEO TRANSCEIVER

- Video Transmission Via UTP CAT5 Cable
- 10%~20% Wire Costs Saved
- Full-Motion CCTV Video at Distances up to 2000' (600M)
- Outstanding Interference Rejection and Transient Protection
- Male BNC Allows Connection Directly to the Camera or DVR
- No Power Required
- UP to 3000' (1KM) with Active Receiver or Hub



## DVCA-24

### AC ADAPTER

- Input: AV 100~240V, 50/60Hz
- Output: DC 12V, 2A
- Power: 24W
- 2 A Output
- Connector Size: 5.5 x 2.5mm



## DVCA-548

### AC TO DC ADAPTER

- Input: AV 100~240V, 0.32~0.75A, 50/60Hz
- Output: DC 12V, 5A
- Power: 60W
- 5 A Output
- Connector Size: 5.5 x 2.5mm





**CC-DIN-BNC**

**CAMERA CABLE**

- CCTV DIN Conversion to BNC



**CC-FIN-BNCFE**

**CAMERA CABLE**

- NA CCTV Conversion to Female BNC



**PTC-3**

**FEMALE BC CABLE**

- 2.1 mm



**PTC-4**

**MALE BC CABLE**

- 2.1 mm



**CCC-DC4**

**4 CONNECTOR CABLE**

- Compatible with:  
DVCA-24  
DVCA548



**CCC-DC8**

**8 CONNECTOR CABLE**

- Compatible with:  
DVCA-24  
DVCA548



**CCSL-25**

**CLOSED CIRCUIT TELEVISION**

- 25 FT.

RG59 Siamese Cable is a Heavily Shielded Cable which Contains both the Video (COAX) Cable and the Power Cable (18 Gauge 2 Conductor) in One Jacket.

The Advantages to Using this Cable is that its more Durable, and you can Run it Long Distances without Interference.

Includes 2 BNC -> RCA Male Adapters in Case your Camera uses RCA Connectors (Component Video) instead of BNC (RF)



**CCSL-100**

**CLOSED CIRCUIT TELEVISION**

- 100 FT.

RG59 Siamese Cable is a Heavily Shielded Cable which Contains both the Video (COAX) Cable and the Power Cable (18 Gauge 2 Conductor) in One Jacket. The Advantages to Using this Cable is that its more Durable, and you can Run it Long Distances without Interference. Includes 2 BNC -> RCA Male Adapters in Case your Camera uses RCA Connectors (Component Video) instead of BNC (RF)





**CLOSED CIRCUIT TELEVISION**

**CCSL-150**

**CLOSED CIRCUIT TELEVISION**

- 150 FT.

RG59 Siamese Cable is a Heavily Shielded Cable which Contains both the Video (COAX) Cable and the Power Cable (18 Gauge 2 Conductor) in One Jacket. The Advantages to Using this Cable is that its more Durable, and you can Run it Long Distances without Interference. Includes 2 BNC -> RCA Male Adapters in Case your Camera uses RCA Connectors (Component Video) instead of BNC (RF)



**CCSL-25 WHT**

**CLOSED CIRCUIT TELEVISION EXTENSION CABLE**

- 25 FT.
- White Color

CCTV ECONOMY EXTENSION CA RG59 Siamese Cable is a Heavily Shielded Cable which Contains both the Video (COAX) Cable and the Power Cable (18 Gauge 2 Conductor) in One Jacket. The Advantages to Using this Cable is that its more Durable, and you can Run it Long Distances without Interference. Includes 2 BNC -> RCA Male Adapters in Case your Camera uses RCA Connectors (Component video) instead of BNC (RF).



**CCSL-50 WHT**

**CLOSED CIRCUIT TELEVISION EXTENSION CABLE**

- 50 FT.
- White Color

CCTV ECONOMY EXTENSION CA RG59 Siamese Cable is a Heavily Shielded Cable which Contains both the Video (COAX) Cable and the Power Cable (18 Gauge 2 Conductor) in One Jacket. The Advantages to using this Cable is that its more Durable, and you can Run it Long Distances without Interference. Includes 2 BNC -> RCA Male Adapters in Case your Camera uses RCA Connectors (component video) instead of BNC (RF).



**CCSL-100 WHT**

**CLOSED CIRCUIT TELEVISION EXTENSION CABLE**

- 100 FT.
- White Color

CCTV ECONOMY EXTENSION CA RG59 Siamese cable is a heavily shielded cable which contains both the video (COAX) cable and the power cable (18 gauge 2 conductor) in one jacket. The advantages to using this cable is that its more durable, and you can run it long distances without interference. Includes 2 BNC -> RCA Male adapters in case your camera uses RCA connectors (component video) instead of BNC (RF).



### CCSL-150 WHT

#### CLOSED CIRCUIT TELEVISION EXTENSION CABLE

- 150 FT.

- White Color

CCTV ECONOMY EXTENSION CA RG59 Siamese Cable is a Heavily Shielded Cable which Contains both the Video (COAX) Cable and the Power Cable (18 Gauge 2 Conductor) in One Jacket. The Advantages to Using this Cable is that its more Durable, and you can Run it Long Distances without Interference. Includes 2 BNC -> RCA Male Adapters in Case your Camera Uses RCA Connectors (Component Video) instead of BNC (RF).



### RCN-AC101

#### UNIVERSAL A/C REMOTE

- Consolidates up to 1000 Remotes
- Compatible with Most Popular Brands
- This Universal Air Conditioner Remote has been Designed to Control Multiple Brands and Models
- Fast Brand and Digital Code Searching
- Long Transmitting Range with Low Power Consumption
- Large LCD Screen Provides Easy Settings and Operation
- On/Off Timer and Night Illumination
- Built-In Clock



### RC-100

#### WIRELESS REMOTE DOOR CHIME

- Easy to Install, no Wiring or AC Power Required
- Pleasant "Dingdong" Sound
- Can be used as a Door Bell or an Alert
- Low Power Consumption



### USI-1227L

#### SMOKE & FIRE ALARM

- Low Battery Audible Indicator
- Mounting Hardware Included
- Large Ring Mounting Bracket
- Fast and Easy Installation
- Test Button



### WDB-700CA

#### PIR SENSOR WIRELESS DOORBELL

- Easy for Installation
- Used as Doorbell, Guest Welcome & Alarm
- 32 Melodies
- Sense Range: Max 8M
- Beam Angle: 90°
- Application: Store, Home, Office



### WDB-301C

#### WIRELESS DOORBELL

- Easy for Installation
- Self-Learning Code Function, No Interference
- Includes 25 Selectable Tones
- 3 Grade Volume Adjusting
- IP55 Water Proof
- Transmitter Battery Lifespan: 1 Year
- Working Frequency: 433.92MHz
- Receiver Rated Voltage: AC110-220V
- Receiver Standby Current: <5mA
- Receiving Sensitivity: -107dBm



### WDB-403BF

#### KINETIC, BATTERY FREE, DOORBELL

- Operating Distance up to 200M
- Self-Learning Code Function
- 58 Pcs. Music for Choosing
- Grade Volume Adjusting;
- IP44 Water Proof;
- Music and Indicate Light 4 Mode for Choosing, Ringing + Flashing Light / Ringing Only / Flashing Light Only / Ringing + Lighting all the Time
- Transmitter Button Lifespan: 200k Times





**WWW.NIPPONAMERICA.COM • 305.592.2616**

**1195 NW 97th Ave. Doral, FL 33172**